

AVX RF Microwave Products

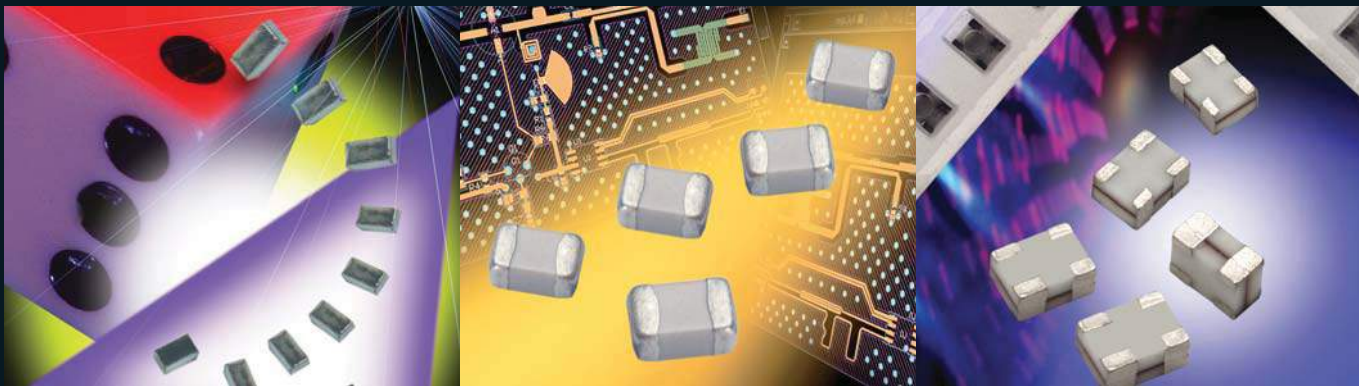

Version 10.9

AVX
A KYOCERA GROUP COMPANY

*AVX Microwave
Ask The World Of Us*

As one of the world's broadest line multilayer ceramic chip capacitor suppliers, and a major Thin Film RF/Microwave capacitor, inductor, directional coupler and low pass filter and microwave ceramic capacitor manufacturer, it is our mission to provide **First In Class** Technology, Quality and Service, by establishing progressive design, manufacturing and continuous improvement programs driving toward a single goal:

TOTAL CUSTOMER SATISFACTION

QV2000

Table of Contents

Company Profile	4
Thin-Film RF/Microwave Technology – Accu-F® / Accu-P®	5-24
Thin-Film Technology	6
Thin-Film Chip Capacitors	7
Thin-Film Chip Capacitors for RF Signal and Power Applications	8
Accu-F®	9
Accu-P®	10
0201 Typical Electrical Tables – Accu-P®	11
0402 Typical Electrical Tables – Accu-P®	12-13
0603 Typical Electrical Tables – Accu-F® / Accu-P®	14
0805 Typical Electrical Tables – Accu-F® / Accu-P®	15
1210 Typical Electrical Tables – Accu-P®	16
High Frequency Characteristics	17-19
Environmental / Mechanical Characteristics	20
Performance Characteristics RF Power Applications	21
Application Notes	22-23
Automatic Insertion Packaging	24
Thin-Film RF/Microwave Inductor Technology – Accu-L®	25-32
L0402 Tight Tolerance RF Inductor	26-27
SMD High-Q RF Inductor – Accu-L®	28-30
Environmental Characteristics	31
Application Notes	32
Thin-Film RF/Microwave Directional Couplers – CP0402/CP0603/CP0805 and DB0603N/DB0805 3dB 90°	33-76
CP0402P High Directivity, Tight Coupling Tolerance	34-35
CP0402 High Directivity LGA Termination	36-39
CP0603 High Directivity LGA Termination	40-44
CP0402 and CP0603 Test Jigs	45
CP0603 SMD Type	46-48
CP0603 SMD Type – High Directivity	49
CP0805 SMD Type	50-53
CP0805 and CP0603 Test Jigs	54
DB0603N 3dB 90° Couplers	55-63
DB0805 3dB 90° Couplers	64-75
DB0805 3dB 90° Test Jigs	76
Thin-Film RF/Microwave Harmonic Low Pass Filter – LP0603/LP0805	77-88
LP0402N Series Harmonic Low Pass Filter Lead-Free LGA Termination	78-79
LP0402N Series Harmonic Low Pass Filter Lead-Free LGA Termination Test Jigs	80
LP0603 Lead-Free LGA Type	81-82
LP0603 Test Jigs	83-85
LP0805 Type Harmonic	86-87
LP0805 Test Jigs	88
Thin-Film RF/Microwave Products – Designer Kits	89-91
RF/Microwave Multilayer Capacitors (MLC)	92-134
UQ Series	93-99
MK Series	100-102
SQ Series	103-115
AQ Series	116-119
MIL-PRF-55681 “BG” Voltage Temperature Limits (+90±20ppm/°C)	120-122
• CDR11BG; CDR12BG (0.055" x 0.055") - Failure Rate Level: M, P, R, S	
• CDR13BG; CDR14BG (0.110" x 0.110") - Failure Rate Level: M, P, R, S	
MIL-PRF-55681 “BP” Voltage Temperature Limits (0±30ppm/°C)	120-122
• CDR11BP; CDR12BP (0.055" x 0.055") - Failure Rate Level: M, P, R, S	
• CDR13BP; CDR14BP (0.110" x 0.110") - Failure Rate Level: M, P, R, S	
Performance Curves	123-127
Automatic Insertion Packaging	128
HQ® Series, High RF Power Capacitors	129-134
RF/Microwave COG (NP0) Capacitors	135-141
Ultra Low ESR “U” Series, COG (NP0) Capacitors (RoHS)	136-138
Ultra Low ESR “U” Series, COG (NP0) Capacitors (Sn/Pb)	139-141
RF/Microwave “U” Series Designer Kits	142-143

Table of Contents

Company Profile	4	
Thin-Film RF/Microwave Technology – Accu-F [®] / Accu-P [®]	5-24	1
Thin-Film RF/Microwave Inductor Technology – Accu-L [®]	25-32	2
Thin-Film RF/Microwave Directional Couplers – CP0402/CP0603/CP0805 and DB0603N/DB0805 3dB 90°	33-76	3
Thin-Film RF/Microwave Harmonic Low Pass Filter – LP0603/LP0805	77-88	4
Thin-Film RF/Microwave Products – Designer Kits	89-91	5
RF/Microwave Multilayer Capacitors (MLC)	92-134	6
RF/Microwave COG (NP0) Capacitors	135-141	7
RF/Microwave “U” Series Designer Kits	142-143	8

AVX Corporation is a leading manufacturer of multilayer ceramic, thin film, tantalum, and glass capacitors, as well as other passive electronic components. These products are used in virtually every variety of electronic system today, including data processing, telecommunications, consumer/automotive electronics, military and aerospace systems, and instrumentation and process controls.

We continually strive to be the leader in all component segments we supply. RF/Microwave capacitors is a thrust business for us. AVX offers a broad line of RF/Microwave Chip Capacitors in a wide range of sizes, styles, and ratings.

The Thin-Film Products range illustrated in this catalog represents the state-of-the-art in RF Capacitors, Inductors, Directional Couplers and Low Pass Filters. The thin-film technology provides components that exhibit excellent batch-to-batch repeatability of electrical parameters at RF frequencies.

The Accu-F[®] and Accu-P[®] series of capacitors are available in ultra-tight tolerances ($\pm 0.02\text{pF}$) as well as non-standard capacitance values.

The Accu-L[®] series of inductors are ideally suited for applications requiring an extremely high Q and high current capability.

The CP0402/CP0603/CP0805 series of Directional Couplers cover the frequency range of 800 MHz to 6 GHz. They feature low insertion loss, high directivity and highly accurate coupling factors.

The LP0603/0805 series of Low Pass Filters provide a rugged component in a small 0603/0805 size package with excellent high frequency performance.

Another major series of microwave capacitors consists of both multilayer porcelain and ceramic capacitors for frequencies from 10 MHz to 4.2 GHz (SQCA & SQCB Series). Four sizes of specially designed ultra-low ESR C0G (NP0) capacitors are covered for RF applications ("U" Series).

Ask the world of us. Call (843) 448-9411.

Or visit our website <http://www.avx.com>

AVX RF

Thin-Film Technology

Accu-F[®] / Accu-P[®]

Thin-Film RF/Microwave Capacitors

Thin-Film Technology

THE IDEAL CAPACITOR

The non-ideal characteristics of a real capacitor can be ignored at low frequencies. Physical size imparts inductance to the capacitor and dielectric and metal electrodes result in resistive losses, but these often are of negligible effect on the circuit. At the very high frequencies of radio communication (>100MHz) and satellite systems (>1GHz), these effects become important. Recognizing that a real capacitor will exhibit inductive and resistive impedances in addition to capacitance, the ideal capacitor for these high frequencies is an ultra low loss component which can be fully characterized in all parameters with total repeatability from unit to unit.

Until recently, most high frequency/microwave capacitors were based on fired-ceramic (porcelain) technology. Layers of ceramic dielectric material and metal alloy electrode paste are interleaved and then sintered in a high temperature oven. This technology exhibits component variability in dielectric quality (losses, dielectric constant and insulation resistance), variability in electrode conductivity and variability in physical size (affecting inductance). An alternate thin-film technology has been developed which virtually eliminates these variances. It is this technology which has been fully incorporated into Accu-F® and Accu-P® to provide high frequency capacitors exhibiting truly ideal characteristics.

The main features of Accu-F® and Accu-P® may be summarized as follows:

- High purity of electrodes for very low and repeatable ESR.
- Highly pure, low-K dielectric for high breakdown field, high insulation resistance and low losses to frequencies above 40GHz.
- Very tight dimensional control for uniform inductance, unit to unit.
- Very tight capacitance tolerances for high frequency signal applications.

This accuracy sets apart these Thin-Film capacitors from ceramic capacitors so that the term Accu has been employed as the designation for this series of devices, an abbreviation for “accurate.”

THIN-FILM TECHNOLOGY

Thin-film technology is commonly used in producing semiconductor devices. In the last two decades, this technology has developed tremendously, both in performance and in process control. Today’s techniques enable line definitions of below 1µm, and the controlling of thickness of layers at 100Å (10⁻²µm). Applying this technology to the manufacture of capacitors has enabled the development of components where both electrical and physical properties can be tightly controlled.

The thin-film production facilities at AVX consist of:

- Class 1000 clean rooms, with working areas under laminar-flow hoods of class 100, (below 100 particles per cubic foot larger than 0.5µm).
- High vacuum metal deposition systems for high-purity electrode construction.
- Photolithography equipment for line definition down to 2.0µm accuracy.
- Plasma-enhanced CVD for various dielectric depositions (CVD=Chemical Vapor Deposition).
- High accuracy, microprocessor-controlled dicing saws for chip separation.
- High speed, high accuracy sorting to ensure strict tolerance adherence.

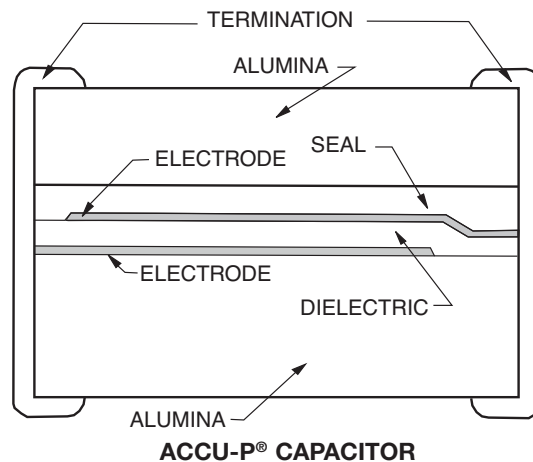

Thin-Film Chip Capacitors

ACCU-F® TECHNOLOGY

The use of very low-loss dielectric materials, silicon dioxide and silicon oxynitride, in conjunction with highly conductive electrode metals results in low ESR and high Q. These high-frequency characteristics change at a slower rate with increasing frequency than for ceramic microwave capacitors.

Because of the thin-film technology, the above-mentioned frequency characteristics are obtained without significant compromise of properties required for surface mounting.

The main Accu-F® properties are:

- Internationally agreed sizes with excellent dimensional control.
- Small size chip capacitors (0603) are available.
- Tight capacitance tolerances.
- Low ESR at VHF, UHF and microwave frequencies.
- High stability with respect to time, temperature, frequency and voltage variation.
- Nickel/solder-coated terminations to provide excellent solderability and leach resistance.

ACCU-F® FEATURES

Accu-F® meets the fast-growing demand for low-loss (high-Q) capacitors for use in surface mount technology especially for the mobile communications market, such as cellular radio of 450 and 900 MHz, UHF walkie-talkies, UHF cordless telephones to 2.3 GHz, low noise blocks at 11-12.5 GHz and for other VHF, UHF and microwave applications.

Accu-F® is currently unique in its ability to offer very low capacitance values (0.1pF) and very tight capacitance tolerances ($\pm 0.05\text{pF}$). Typically Accu-F® will be used in small signal applications in VCO's, matching networks, filters, etc.

Inspection test and quality control procedures in accordance with ISO 9001, CECC, IECQ and USA MIL Standards yield products of the highest quality.

APPLICATIONS

Cellular Communications	Radar Systems
CT2/PCN (Cordless Telephone/Personal Comm. Networks)	Video Switching
Satellite TV	Test & Measurements
Cable TV	Filters
GPS (Global Positioning Systems)	VCO's
Vehicle Location Systems	Matching Networks
Vehicle Alarm Systems	
Paging	
Military Communications	

APPROVALS

ISO 9001

ACCU-P® TECHNOLOGY

As in the Accu-F® series the use of very low-loss dielectric materials (silicon dioxide and silicon oxynitride) in conjunction with highly conductive electrode metals results in low ESR and high Q. At high frequency these characteristics change at a slower rate with increasing frequency than conventional ceramic microwave capacitors. Using thin-film technology, the above-mentioned frequency characteristics are obtained without significant compromise of properties required for surface mounting. The use of high thermal conductivity materials results in excellent RF power handling capabilities.

The main Accu-P® properties are:

- Enhanced RF power handling capability.
- Improved mechanical characteristics.
- Internationally agreed sizes with excellent dimensional control.
- Ultra Small size chip capacitors (0201) are available.
- Tight capacitance tolerances.
- Low ESR at UHF, VHF, and microwave frequencies.
- High-stability with respect to time, temperature, frequency and voltage variation.
- High temperature nickel/solder-coated terminations as standard to provide excellent solderability and leach resistance.

ACCU-P® FEATURES

- Minimal batch to batch variability of parameters at high frequency.
- The Accu-P® has the same unique features as the Accu-F® capacitor such as low ESR, high Q, availability of very low capacitance values and very tight capacitance tolerances.
- The RF power handling capability of the Accu-P® allows for its usage in both small signal and RF power applications.
- Inspection, test and quality control procedures in accordance with ISO 9001, CECC, IECQ and USA MIL Standards guarantee product of the highest quality.
- Hand soldering Accu-P®: Due to their construction utilizing relatively high thermal conductivity materials, Accu-P's have become the preferred device in R & D labs and production environments where hand soldering is used. Accu-P's are available in all sizes and are electrically identical to their Accu-F counterparts.

APPLICATIONS

Cellular Communications	Radar Systems
CT2/PCN (Cordless Telephone/Personal Comm. Networks)	Video Switching
Satellite TV	Test & Measurements
Cable TV	Filters
GPS (Global Positioning Systems)	VCO's
Vehicle Location Systems	Matching Networks
Vehicle Alarm Systems	RF Amplifiers
Paging	
Military Communications	

APPROVALS

ISO 9001

Accu-F® */ Accu-P®

Thin-Film Chip Capacitors for RF Signal and Power Applications



1

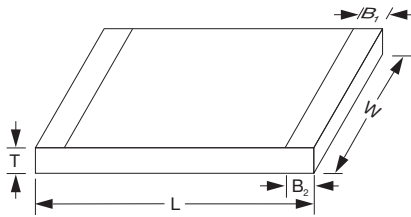

ACCU-F® *(Signal Type)

	0603	0805
L	1.60±0.1 (0.063±0.004)	2.01±0.1 (0.079±0.004)
W	0.81±0.1 (0.032±0.004)	1.27±0.1 (0.050±0.004)
T	0.63±0.1 (0.025±0.004)	0.63±0.1 (0.025±0.004)
B	0.30±0.1 (0.012±0.004)	0.30±0.1 (0.012±0.004)

*Not recommended for new designs. Accu-P's are recommended. DIMENSIONS: millimeters (inches)

ACCU-P® (Signal and Power Type Capacitors)

	0201	0402*	0603*	0805*	1210
L	0.60±0.05 (0.023±0.002)	1.00±0.1 (0.039±0.004)	1.60±0.1 (0.063±0.004)	2.01±0.1 (0.079±0.004)	3.02±0.1 (0.119±0.004)
W	0.325±0.050 (0.0128±0.002)	0.55±0.07 (0.022±0.003)	0.81±0.1 (0.032±0.004)	1.27±0.1 (0.050±0.004)	2.5±0.1 (0.100±0.004)
T	0.225±0.050 (0.009±0.002)	0.40±0.1 (0.016±0.004)	0.63±0.1 (0.025±0.004)	0.93±0.2 (0.036±0.008)	0.93±0.2 (0.036±0.008)
B₁	0.10±0.10 (0.004±0.004)	0.00 ^{+0.1} _{-0.0} (0.000 ^{+0.004} _{-0.000})	0.35±0.15 (0.014±0.006)	0.30±0.1 (0.012±0.004)	0.43±0.1 (0.017±0.004)
B₂	0.15±0.05 (0.006±0.002)	0.20±0.1 (0.008±0.004)	0.35±0.15 (0.014±0.006)	0.30±0.1 (0.012±0.004)	0.43±0.1 (0.017±0.004)

*Mount Black Side Up DIMENSIONS: millimeters (inches)

HOW TO ORDER

0402 T	3 T	J T	4R7 T	A T	B T	S T	TR T
Size 0201* 0402* 0603 0805 1210*	Voltage 1 = 100V 5 = 50V 3 = 25V Y = 16V Z = 10V	Temperature Coefficient (1) J = 0±30ppm/°C (-55°C to +125°C) K = 0±60ppm/°C (-55°C to +125°C)	Capacitance Capacitance expressed in pF. (2 significant digits + number of zeros) for values <10pF , letter R denotes decimal point. Example: 68pF = 680 8.2pF = 8R2	Tolerance for C≤2.0pF* P = ±0.02pF Q = ±0.03pF A = ±0.05pF B = ±0.1pF C = ±0.25pF for C≤3.0pF Q = ±0.03pF A = ±0.05pF B = ±0.1pF C = ±0.25pF for C≤5.6pF A = ±0.05pF B = ±0.1pF C = ±0.25pF for 5.6pF<C<10pF B = ±0.1pF C = ±0.25pF D = ±0.5pF for C≥10pF F = ±1% G = ±2% J = ±5%	Specification Code A = Accu-F® technology B = Accu-P® technology	Termination Code W = Nickel/Solder Coated Accu-F® Sn63, Pb37 Accu-P® 0402 Sn90, Pb10 T = Nickel/High Temperature Solder Coated Accu-P® 0805**, 1210** Sn96, Ag4 Nickel/Solder Coated Accu-P® 0603 Sn63, Pb37 **S = Nickel/Lead Free Solder Coated Accu-P® 0201, 0402, 0603 Sn100	Packaging Code TR = Tape & Reel

* Accu-P ONLY

(1) TC's shown are per EIA/IEC Specifications.



Please select correct termination style

Engineering Kits Available
see pages 90-91

*Tolerances as tight as ±0.01pF are available. Please consult the factory.

ELECTRICAL SPECIFICATIONS

Operating and Storage Temperature Range	-55°C to +125°C
Temperature Coefficients ⁽¹⁾	0 ± 30ppm/°C dielectric code "J" / 0 ± 60ppm/°C dielectric code "K"
Capacitance Measurement	1 MHz, 1 Vrms
Insulation Resistance (IR)	≥10 ¹¹ Ohms (≥10 ¹⁰ Ohms for 0201 and 0402 size)
Proof Voltage	2.5 U _R for 5 secs.
Aging Characteristic	Zero
Dielectric Absorption	0.01%

(1) TC's shown are per EIA/IEC Specifications.



Signal Type Capacitors

Accu-F® Capacitance Ranges (pF)

TEMP. COEFFICIENT CODE

“J” = 0±30ppm/°C
(-55°C to +125°C)⁽²⁾

Size		0603			0805		
Size Code		0603			0805		
Voltage		100	50	25	100	50	25
Cap in pF ⁽¹⁾	Cap code						
0.1	— 0R1						
0.2	— 0R2						
0.3	— 0R3						
0.4	— 0R4						
0.5	— 0R5						
0.6	— 0R6						
0.7	— 0R7						
0.8	— 0R8						
0.9	— 0R9						
1.0	— 1R0						
1.2	— 1R2						
1.5	— 1R5						
1.8	— 1R8						
2.2	— 2R2						
2.7	— 2R7						
3.3	— 3R3						
3.9	— 3R9						
4.7	— 4R7						
5.6	— 5R6						
6.8	— 6R8						
8.2	— 8R2						
10	— 100						
12	— 120						
15	— 150						
18	— 180						
22	— 220						
27	— 270						
33	— 330						
39	— 390						
47	— 470						
56	— 560						
68	— 680						
82	— 820						
100	— 101						
120	— 121						
150	— 151						

⁽¹⁾ For capacitance values higher than listed in table, please consult factory.

⁽²⁾ TC shown is per EIA/IEC Specifications.

TEMP. COEFFICIENT CODE

“K” = 0±60ppm/°C
(-55°C to +125°C)⁽²⁾

Size		0603			0805		
Size Code		0603			0805		
Voltage		100	50	25	100	50	25
Cap in pF ⁽¹⁾	Cap code						
0.1	— 0R1						
0.2	— 0R2						
0.3	— 0R3						
0.4	— 0R4						
0.5	— 0R5						
0.6	— 0R6						
0.7	— 0R7						
0.8	— 0R8						
0.9	— 0R9						
1.0	— 1R0						
1.2	— 1R2						
1.5	— 1R5						
1.8	— 1R8						
2.2	— 2R2						
2.7	— 2R7						
3.3	— 3R3						
3.9	— 3R9						
4.7	— 4R7						
5.6	— 5R6						
6.8	— 6R8						
8.2	— 8R2						
10	— 100						
12	— 120						
15	— 150						
18	— 180						
22	— 220						
27	— 270						
33	— 330						
39	— 390						
47	— 470						
56	— 560						
68	— 680						
82	— 820						
100	— 101						
120	— 121						
150	— 151						

⁽¹⁾ For capacitance values higher than listed in table, please consult factory.

⁽²⁾ TC shown is per EIA/IEC Specifications.

Intermediate values are available within the indicated range.

*Not recommended for new designs.
Accu-P's are recommended.

0201 Typical Electrical Tables



Capacitance @ 1 MHz (pF)	Self Resonance Frequency (GHz) Typical	250MHz			500MHz			750MHz			1000MHz			1250MHz		
		Typ. C(eff) (pF)	Typ. Q	Typ. ESR (mΩ)	Typ. C(eff) (pF)	Typ. Q	Typ. ESR (mΩ)	Typ. C(eff) (pF)	Typ. Q	Typ. ESR (mΩ)	Typ. C(eff) (pF)	Typ. Q	Typ. ESR (mΩ)	Typ. C(eff) (pF)	Typ. Q	Typ. ESR (mΩ)
0.8	9.1	0.84	2154	360	0.84	630	603	0.85	424	594	0.85	327	577	0.86	255	588
1.2	7.6	1.21	1375	405	1.21	525	517	1.22	341	527	1.23	267	503	1.23	208	515
1.8	6.3	1.84	1298	271	1.85	520	341	1.86	337	347	1.87	270	326	1.88	201	347
2.2	5.7	2.23	1355	214	2.24	512	281	2.25	335	284	2.27	264	270	2.29	199	284
3.3	4.6	3.29	1295	156	3.31	430	230	3.33	285	230	3.36	220	223	3.40	159	242
3.9	4.3	3.91	1902	93	3.93	460	181	3.97	298	185	4.02	227	181	4.08	163	198
4.7	3.9	4.71	1677	84	4.74	391	174	4.80	252	178	4.87	181	183	4.97	130	200
5.6	3.6	5.62	1391	84	5.67	370	154	5.74	257	148	5.83	195	144	5.95	140	157
6.8	3.3	6.77	1135	84	6.83	314	149	6.91	217	142	7.03	164	139	7.18	118	151

Capacitance @ 1 MHz (pF)	Self Resonance Frequency (GHz) Typical	1500MHz			1750MHz			2250MHz			2500MHz			2750MHz		
		Typ. C(eff) (pF)	Typ. Q	Typ. ESR (mΩ)	Typ. C(eff) (pF)	Typ. Q	Typ. ESR (mΩ)	Typ. C(eff) (pF)	Typ. Q	Typ. ESR (mΩ)	Typ. C(eff) (pF)	Typ. Q M	Typ. ESR (mΩ)	Typ. C(eff) (pF)	Typ. Q	Typ. ESR (mΩ)
0.8	9.1	0.86	204	611	0.87	168	631	0.88	141	587	0.89	126	571	0.90	122	532
1.2	7.6	1.24	155	565	1.26	129	577	1.28	92	570	1.30	89	566	1.31	81	558
1.8	6.3	1.90	148	388	1.92	123	395	1.96	96	395	1.99	83	396	2.02	74	397
2.2	5.7	2.32	145	320	2.34	123	322	2.41	93	329	2.46	81	328	2.50	72	330
3.3	4.6	3.45	119	266	3.50	101	263	3.63	74	277	3.73	64	276	3.84	55	281
3.9	4.3	4.16	122	216	4.25	103	214	4.46	75	224	4.63	64	223	4.79	56	225
4.7	3.9	5.08	99	213	5.23	83	212	5.55	60	221	5.83	50	222	6.10	43	224
5.6	3.6	6.11	108	166	6.31	91	164	6.76	64	174	7.16	53	175	7.56	45	141
6.8	3.3	7.38	93	155	7.63	76	158	8.22	54	166	8.74	44	169	9.29	37	173

0402 Typical Electrical Tables

1

Capacitance & Tolerance* @ 1 MHz (pF)	Self Resonance Frequency (GHz) Typical	Ref Freq (MHz)	Typ. C(eff) (pF)	Typ. Q	Typ. ESR (Ω)	Ref Freq (MHz)	Typ. C(eff) (pF)	Typ. Q	Typ. ESR (Ω)	Ref Freq (MHz)	Typ. C(eff) (pF)	Typ. Q	Typ. ESR (Ω)	Ref Freq (MHz)	Typ. C(eff) (pF)	Typ. Q	Typ. ESR (Ω)	Ref Freq (MHz)	Typ. C(eff) (pF)	Typ. Q	Typ. ESR (Ω)	
0.1±0.05	19.4	n/a	n/a	n/a	n/a	n/a	n/a	n/a	n/a	n/a	n/a	n/a	n/a	n/a	n/a	n/a	n/a	n/a	n/a	n/a	n/a	n/a
0.2±0.05	16.4	n/a	n/a	n/a	n/a	n/a	n/a	n/a	n/a	n/a	n/a	n/a	n/a	n/a	n/a	n/a	n/a	n/a	n/a	n/a	n/a	n/a
0.3±0.05	14.6	n/a	n/a	n/a	n/a	n/a	n/a	n/a	n/a	n/a	n/a	n/a	n/a	n/a	n/a	n/a	n/a	n/a	n/a	n/a	n/a	n/a
0.4±0.05	12.5	n/a	n/a	n/a	n/a	n/a	n/a	n/a	n/a	n/a	n/a	n/a	n/a	n/a	n/a	n/a	n/a	n/a	n/a	n/a	n/a	n/a
0.5±0.05	11.3	n/a	n/a	n/a	n/a	n/a	n/a	n/a	n/a	n/a	n/a	n/a	n/a	n/a	n/a	n/a	n/a	n/a	n/a	n/a	n/a	n/a
0.6±0.05	10.4	n/a	n/a	n/a	n/a	n/a	n/a	n/a	n/a	n/a	n/a	n/a	n/a	n/a	n/a	n/a	n/a	n/a	n/a	n/a	n/a	n/a
0.7±0.05	9.5	n/a	n/a	n/a	n/a	n/a	n/a	n/a	n/a	n/a	n/a	n/a	n/a	n/a	n/a	n/a	n/a	n/a	n/a	n/a	n/a	n/a
0.8±0.05	9.1	n/a	n/a	n/a	n/a	n/a	n/a	n/a	n/a	n/a	n/a	n/a	n/a	n/a	n/a	n/a	n/a	n/a	n/a	n/a	n/a	n/a
0.9±0.05	8.8	n/a	n/a	n/a	n/a	n/a	n/a	n/a	n/a	n/a	n/a	n/a	n/a	n/a	n/a	n/a	n/a	n/a	n/a	n/a	n/a	n/a
1.0±0.05	8	247	1.16	1635	0.34	494	1.15	1283	0.22	742	1.13	870	0.22	991	1.12	620	0.23	1240	1.14	474	0.25	0.25
1.10±0.05	7.8	246	1.25	1581	0.32	492	1.22	1219	0.21	740	1.21	791	0.22	989	1.19	561	0.24	1238	1.21	425	0.25	0.25
1.20±0.05	7.4	245	1.34	1538	0.30	491	1.33	1153	0.21	738	1.31	727	0.22	986	1.3	503	0.25	1234	1.33	372	0.25	0.25
1.30±0.05	7	244	1.42	1502	0.29	490	1.42	1109	0.21	736	1.4	701	0.21	983	1.35	480	0.24	1230	1.41	350	0.25	0.25
1.40±0.05	6.8	243	1.53	1476	0.28	488	1.54	1061	0.20	733	1.52	680	0.21	980	1.49	461	0.23	1229	1.53	333	0.25	0.25
1.50±0.05	6.5	242	1.63	1454	0.28	486	1.63	1002	0.20	731	1.58	638	0.21	978	1.6	438	0.23	1226	1.65	316	0.25	0.25
1.60±0.05	6.5	242	1.71	1448	0.27	485	1.76	986	0.20	729	1.69	622	0.21	986	1.71	429	0.23	1224	1.77	309	0.24	0.24
1.70±0.05	6.4	241	1.85	1444	0.27	483	1.81	970	0.19	728	1.75	612	0.20	985	1.75	422	0.22	1223	1.86	305	0.23	0.23
1.80±0.05	6.2	240	1.93	1430	0.26	482	1.86	931	0.19	727	1.83	597	0.20	983	1.8	413	0.22	1220	1.91	299	0.23	0.23
1.90±0.05	6	239	2.01	1421	0.25	481	1.93	897	0.19	726	1.91	583	0.20	972	1.91	401	0.21	1219	1.97	294	0.22	0.22
2.00±0.05	5.7	239	2.11	1410	0.24	480	2.06	896	0.18	722	2.11	582	0.19	969	2.01	400	0.20	1215	2.11	293	0.21	0.21
2.10±0.05	5.4	238	2.21	1406	0.23	478	2.14	893	0.17	720	2.21	581	0.18	966	2.1	398	0.19	1213	2.22	291	0.20	0.20
2.20±0.05	5.1	237	2.28	1406	0.22	476	2.27	893	0.16	718	2.26	581	0.17	964	2.27	396	0.18	1212	2.25	289	0.19	0.19
2.30±0.05	5	237	2.32	1405	0.20	475	2.36	870	0.16	716	2.4	549	0.17	962	2.3	379	0.18	1209	2.4	262	0.20	0.20
2.40±0.05	4.9	236	2.45	1404	0.19	473	2.48	845	0.16	715	2.51	501	0.17	960	2.41	358	0.19	1208	2.53	253	0.20	0.20
2.50±0.05	4.7	235	2.49	1404	0.18	472	2.6	821	0.16	714	2.62	486	0.17	959	2.52	349	0.19	1205	2.7	240	0.20	0.20
2.60±0.05	4.6	234	2.6	1402	0.16	470	2.71	799	0.15	712	2.73	477	0.17	958	2.65	331	0.19	1204	2.85	231	0.20	0.20
2.70±0.05	4.5	233	2.84	1399	0.15	469	2.83	778	0.15	711	2.82	464	0.17	956	2.86	313	0.19	1203	3	224	0.20	0.20
2.80±0.05	4.5	233	2.85	1395	0.15	468	2.94	769	0.15	710	2.9	458	0.16	954	2.91	308	0.18	1202	3.12	220	0.20	0.20
2.90±0.05	4.4	232	2.87	1395	0.15	467	3.11	751	0.15	710	2.99	450	0.16	953	3.15	303	0.18	1201	3.24	218	0.19	0.19
3.00±0.05	4.4	231	2.88	1392	0.14	466	3.39	746	0.15	709	3.11	440	0.16	952	3.41	299	0.18	1201	3.33	212	0.19	0.19
3.10±0.05	4.4	230	2.9	1392	0.14	465	3.45	733	0.15	708	3.22	429	0.16	951	3.48	291	0.18	1199	3.45	207	0.19	0.19
3.20±0.05	4.3	230	2.91	1391	0.14	464	3.61	725	0.15	707	3.3	421	0.16	950	3.68	285	0.17	1198	3.58	203	0.19	0.19
3.30±0.05	4.3	229	2.92	1391	0.14	462	3.72	711	0.14	707	3.42	415	0.16	949	3.8	282	0.17	1197	3.61	198	0.19	0.19
3.40±0.05	4.3	228	2.93	1390	0.14	461	3.78	705	0.14	706	3.53	407	0.15	948	3.79	276	0.17	1196	3.78	195	0.19	0.19
3.50±0.05	4.2	227	2.95	1389	0.13	460	3.82	693	0.14	705	3.6	402	0.15	947	3.85	273	0.16	1195	3.91	191	0.18	0.18
3.60±0.05	4.2	226	2.97	1382	0.13	459	3.87	688	0.14	704	3.7	395	0.15	946	3.89	270	0.16	1194	4	186	0.18	0.18
3.70±0.05	4.1	226	2.99	1381	0.13	458	3.93	667	0.14	702	3.81	389	0.15	945	3.95	262	0.16	1193	4.1	181	0.18	0.18
3.80±0.05	4	225	4	1380	0.13	458	4	658	0.13	699	3.9	386	0.15	944	4.02	256	0.16	1192	4.23	177	0.18	0.18
3.90±0.05	3.9	224	4.01	1379	0.13	457	4.01	649	0.13	697	4.02	384	0.15	943	4.11	251	0.16	1191	4.37	172	0.18	0.18
4.00±0.05	3.9	224	4.09	1372	0.12	457	4.07	650	0.13	696	4.11	381	0.14	942	4.18	250	0.16	1190	4.46	170	0.18	0.18
4.10±0.05	3.8	223	4.18	1370	0.12	456	4.18	655	0.13	696	4.2	380	0.14	941	4.23	248	0.15	1190	4.52	169	0.17	0.17
4.20±0.05	3.8	223	4.27	1356	0.12	455	4.27	658	0.12	695	4.29	379	0.14	940	4.37	247	0.15	1199	4.66	167	0.17	0.17
4.30±0.05	3.7	222	4.36	1355	0.12	454	4.34	657	0.12	694	4.43	373	0.14	939	4.58	246	0.15	1195	4.75	168	0.17	0.17
4.40±0.05	3.7	222	4.44	1351	0.11	453	4.45	660	0.12	693	4.5	369	0.14	939	4.62	246	0.14	1192	4.82	162	0.16	0.16
4.50±0.05	3.6	221	4.53	1350	0.11	452	4.52	665	0.12	692	4.6	364	0.13	938	4.7	245	0.14	1190	4.96	161	0.16	0.16
4.60±0.05	3.6	221	4.62	1347	0.11	451	4.62	670	0.11	691	4.72	359	0.13	938	4.79	244	0.14	1188	5.07	161	0.16	0.16
4.70±0.05	3.5	220	4.75	1343	0.11	450	4.74	673	0.11	690	4.74	351	0.13	937	4.86	244	0.14	1186	5.18	159	0.16	0.16
5.10±0.05	3.4	217	5.19	1310	0.11	447	5.16	589	0.11	687	5.23	348	0.13	934	5.53	230	0.14	1184	5.82	131	0.16	0.16
5.60±0.05	3.3	214	5.74	1297	0.11	443	5.75	576	0.11	684	5.81	342	0.12	932	6.01	201	0.14	1182	6.62	129	0.16	0.16
6.2±0.1	3	211	6.31	1244	0.10	440	6.09	585	0.10	681	6.33	339	0.11	928	6.68	202	0.12	1180	7.34	128	0.15	0.15
6.8±0.1	2.8	208	6.92	1202	0.09	436	6.94	591	0.09	678	7.04	334	0.10	926	7.39	203	0.11	1177	8.22	127	0.14	0.14
7.5±0.1	2.7	205	7.57	1155	0.08	433	7.51	567	0.09	675	7.85	320	0.10	924	8.17	191	0.10	1176	9.01	120	0.13	0.13
8.2±0.1	2.6	202	8.35	1116	0.08	430	8.36	542	0.08	673	8.48	306	0.09	922	8.93	186	0.10	1174	10.04	118	0.13	0.13
9.1±0.1	2.5	199	9.23	1059	0.09	428	9.28	458	0.09	670	9.87	249	0.10	920	10.2	152	0.11	1172	11.98	88	0.13	0.13
10.0±1%	2.4	196	10.14	936	0.09	424	10.24	385	0.10	668	10.55	202	0.11	919	11.49	118	0.13	1171	13.75	70	0.12	0.12
11.0±1%	2.3	193	11.19	912	0.08	421	11.17	363	0.09	666	11.81	185	0.11	917	12.87	103	0.12	1170	15.3	61	0.12	0.12
12.0±1%	2.2	189	12.16	889	0.08	418	12.3	348	0.09	664	12.77	173	0.11	915	14.16	95	0.13	1168	17.63	52	0.12	0.12
13.0±1%	2.2	186	13.3	984	0.07	416	13.32	363	0.08	661	14.1	183	0.09	912	15.8	101	0.11	1164	23.9	47	0.12	0.12
14.0±1%	2.1	184	14.26	802	0.08	414	14.44	298	0.09	660	15.03	149	0.12	913	16.72	76.7	0.14	1167	23.1	40	0.15	0.15
15.0±1%	2.1	182	15.34	791	0.07	413	15.46	283	0.08	660	16.16	138	0.10	912	18.51	82	0.16	1166	23.6	44		

0402 Typical Electrical Tables

1

Table with 23 columns: Capacitance & Tolerance* @ 1 MHz (pF), Self Resonance Frequency (GHz) Typical, Ref Freq (MHz), Typ. C(eff) (pF), Typ. Q, Typ. ESR (Ω), Ref Freq (MHz), Typ. C(eff) (pF), Typ. Q, Typ. ESR (Ω), Ref Freq (MHz), Typ. C(eff) (pF), Typ. Q, Typ. ESR (Ω), Ref Freq (MHz), Typ. C(eff) (pF), Typ. Q, Typ. ESR (Ω), Ref Freq (MHz), Typ. C(eff) (pF), Typ. Q, Typ. ESR (Ω).

* Other tolerances are available, see page 8

0603 Typical Electrical Tables

1

Capacitance & Tolerance* @ 1 MHz (pF)	Self Resonance Frequency (GHz)	Ref Freq. MHz	Effective Capacitance Max/Min (pF)	Max ESR (Ω)	Ref Freq. MHz	Effective Capacitance Max/Min (pF)	Max ESR (Ω)	Ref Freq. MHz	Effective Capacitance Max/Min (pF)	Max ESR (Ω)	Ref Freq. MHz	Effective Capacitance Max/Min (pF)	Max ESR (Ω)
0.1±0.05	18.0		N/A	N/A	N/A	N/A	N/A	N/A	N/A	N/A	N/A	N/A	N/A
0.2±0.05	12.7		N/A	N/A	N/A	N/A	N/A	N/A	N/A	N/A	N/A	N/A	N/A
0.3±0.05	10.4		N/A	N/A	N/A	N/A	N/A	N/A	N/A	N/A	N/A	N/A	N/A
0.4±0.05	9.0		N/A	N/A	N/A	N/A	N/A	N/A	N/A	N/A	N/A	N/A	N/A
0.5±0.05	8.1		N/A	N/A	N/A	N/A	N/A	N/A	N/A	N/A	N/A	N/A	N/A
0.6±0.10	7.4		N/A	N/A	N/A	N/A	N/A	N/A	N/A	N/A	N/A	N/A	N/A
0.7±0.10	6.8		N/A	N/A	N/A	N/A	N/A	N/A	N/A	N/A	N/A	N/A	N/A
0.8±0.10	6.4		N/A	N/A	N/A	N/A	N/A	N/A	N/A	N/A	N/A	N/A	N/A
0.9±0.10	6.0		N/A	N/A	N/A	N/A	N/A	N/A	N/A	N/A	N/A	N/A	N/A
1.0±0.10	5.7	245	1.15/0.90	.280	491	1.10/0.90	.220	738	1.10/0.90	.220	987	1.15/0.90	.300
1.1±0.10	5.4	244	1.25/1.00	.270	490	1.25/1.00	.210	736	1.11/1.00	.210	985	1.25/1.00	.290
1.2±0.10	5.2	243	1.35/1.10	.260	487	1.35/1.05	.200	734	1.40/1.05	.210	981	1.35/1.05	.280
1.3±0.10	5.0	242	1.45/1.15	.260	486	1.45/1.15	.200	732	1.45/1.15	.200	974	1.45/1.15	.270
1.4±0.10	4.8	241	1.55/1.25	.250	485	1.55/1.25	.190	731	1.45/1.25	.200	977	1.55/1.25	.260
1.5±0.10	4.7	241	1.65/1.35	.250	484	1.65/1.35	.180	729	1.65/1.35	.190	976	1.70/1.35	.250
1.6±0.10	4.5	240	1.75/1.45	.240	483	1.75/1.45	.180	727	1.75/1.45	.190	973	1.80/1.50	.250
1.7±0.10	4.4	240	1.85/1.55	.230	482	1.85/1.60	.170	725	1.85/1.60	.180	971	1.90/1.60	.250
1.8±0.10	4.2	239	2.10/1.70	.220	479	2.10/1.70	.160	723	2.10/1.70	.170	969	2.15/1.70	.250
1.9±0.10	4.1	239	2.15/1.78	.210	478	2.15/1.80	.160	721	2.15/1.80	.167	967	2.20/1.80	.240
2.0±0.10	4.0	238	2.11/1.80	.205	477	2.11/1.80	.155	720	2.11/1.80	.165	966	2.25/1.90	.230
2.1±0.10	3.9	237	2.25/1.95	.200	475	2.25/1.98	.150	718	2.35/1.98	.162	964	2.35/2.00	.220
2.2±0.10	3.8	236	2.40/2.05	.190	474	2.45/2.05	.145	717	2.42/2.05	.160	962	2.45/2.10	.210
2.4±0.25	3.7	234	2.70/2.15	.175	471	2.75/2.15	.140	713	2.80/2.15	.150	958	2.80/2.15	.200
2.7±0.25	3.5	232	3.00/2.45	.160	468	3.10/2.45	.125	709	3.10/2.45	.145	954	3.15/2.48	.190
3.0±0.25	3.3	230	3.40/2.75	.150	465	3.40/2.75	.120	706	3.40/2.75	.140	951	3.60/2.80	.170
3.3±0.25	3.1	226	3.60/3.05	.130	459	3.70/3.05	.120	699	3.70/3.05	.130	945	3.80/3.10	.165
3.6±0.25	3.0	224	3.90/3.30	.128	456	4.25/3.35	.119	697	3.90/3.35	.125	942	4.10/3.40	.160
3.9±0.25	2.9	223	4.20/3.65	.125	455	4.35/3.70	.115	695	4.90/3.75	.120	940	5.15/3.75	.150
4.3±0.25	2.7	220	4.60/4.00	.122	451	4.80/4.05	.117	692	5.10/4.05	.115	937	5.30/4.05	.150
4.7±0.25	2.6	218	5.00/4.45	.120	448	5.20/4.45	.110	689	5.30/4.50	.115	935	5.50/4.55	.145
5.1±0.25	2.5	216	5.40/4.85	.115	445	5.70/4.89	.105	686	6.00/4.90	.115	931	6.20/5.00	.140
5.6±0.25	2.4	214	5.90/5.35	.110	443	6.10/5.35	.100	684	6.15/5.40	.110	929	6.50/5.50	.135
6.2±0.25	2.3	211	6.50/5.95	.105	439	6.90/5.95	.099	680	7.10/6.00	.110	927	8.00/6.10	.130
6.8±0.25	2.2	208	7.20/6.55	.100	435	7.25/6.55	.099	677	7.50/6.60	.110	925	9.00/6.65	.130
7.5±0.50	2.1	205	8.10/7.00	.095	432	8.10/7.00	.099	675	8.20/7.00	.110	925	9.50/7.05	.125
8.2±0.50	2.0	202	8.80/7.70	.090	429	8.80/7.70	.098	672	9.00/7.70	.110	921	10.00/7.80	.125
9.1±0.50	1.9	200	9.80/8.60	.090	425	10.95/8.65	.098	670	12.00/9.00	.110	919	13.00/9.10	.120
10±5%	1.8	195	10.70/9.50	.085	422	11.60/9.50	.097	667	12.50/9.60	.110	917	16.00/9.90	.120
11±5%	1.7	191	11.60/10.90	.085	420	12.20/10.60	.095	665	13.20/10.50	.110	916	17.00/10.00	.120
12±5%	1.6	189	12.90/11.40	.085	418	13.40/11.50	.095	663	14.60/11.90	.110	914	18.00/12.00	.120
13±5%	1.6	187	13.10/12.90	.080	416	14.00/13.00	.095	661	16.00/13.50	.110	913	21.00/14.00	.120
14±5%	1.5	185	14.90/13.25	.080	414	16.90/14.00	.090	660	19.00/15.00	.110	912	26.00/15.00	.120
15±5%	1.5	182	15.90/14.25	.080	412	17.50/15.30	.090	659	21.00/16.50	.100	911	29.00/17.00	.120
16±5%	1.4	179	17.00/15.15	.070	410	18.00/15.90	.085	657	22.00/17.00	.100	910	30.00/18.00	.120
18±5%	1.3	176	19.50/17.00	.070	408	20.20/17.10	.085	656	23.70/19.00	.100	908	33.00/21.00	.120
22±5%	1.2	170	24.00/20.90	.066	404	25.00/20.90	.080	654	28.00/21.00	.10	906	39.00/21.50	.120
24±5%	1.2	168	26.00/22.80	.066	403	30.00/23.00	.080	653	N/A	.10	905	N/A	.120
27±5%	1.1	165	29.00/25.60	.065	402	36.00/27.00	.080	652	N/A	.10	905	N/A	.120
30±5%	1.0	163	32.00/28.50	.064	401	40.00/30.00	.080	651	N/A	.10	904	N/A	.120
33±5%	1.0	160	37.65/31.35	.064	400	45.00/33.00	.080	650	N/A	.10	904	N/A	.120

* Other tolerances are available, see page 8

0805 Typical Electrical Tables

1

Capacitance & Tolerance* @ 1 MHz (pF)	Self Resonance Frequency (GHz)	Ref Freq. MHz	Effective Capacitance Max/Min (pF)	Max ESR (Ω)	Ref Freq. MHz	Effective Capacitance Max/Min (pF)	Max ESR (Ω)	Ref Freq. MHz	Effective Capacitance Max/Min (pF)	Max ESR (Ω)	Ref Freq. MHz	Effective Capacitance Max/Min (pF)	Max ESR (Ω)
0.1±0.05			N/A	N/A	N/A	N/A	N/A	N/A	N/A	N/A	N/A	N/A	N/A
0.2±0.05			N/A	N/A	N/A	N/A	N/A	N/A	N/A	N/A	N/A	N/A	N/A
0.3±0.05			N/A	N/A	N/A	N/A	N/A	N/A	N/A	N/A	N/A	N/A	N/A
0.4±0.05			N/A	N/A	N/A	N/A	N/A	N/A	N/A	N/A	N/A	N/A	N/A
0.5±0.05			N/A	N/A	N/A	N/A	N/A	N/A	N/A	N/A	N/A	N/A	N/A
0.6±0.10			N/A	N/A	N/A	N/A	N/A	N/A	N/A	N/A	N/A	N/A	N/A
0.7±0.10			N/A	N/A	N/A	N/A	N/A	N/A	N/A	N/A	N/A	N/A	N/A
0.8±0.10			N/A	N/A	N/A	N/A	N/A	N/A	N/A	N/A	N/A	N/A	N/A
0.9±0.10			N/A	N/A	N/A	N/A	N/A	N/A	N/A	N/A	N/A	N/A	N/A
1.0±0.10	5.6	250	1.20/0.90	.320	500	1.20/0.90	.300	750	1.20/0.90	.270	999	1.20/0.90	.300
1.1±0.10	5.4	248	1.30/1.00	.290	496	1.30/1.00	.270	754	1.30/1.00	.250	993	1.30/1.00	.290
1.2±0.10	5.1	245	1.40/1.10	.270	492	1.40/1.10	.250	739	1.40/1.10	.240	987	1.40/1.10	.280
1.3±0.10	4.9	243	1.50/1.20	.260	488	1.50/1.20	.230	734	1.50/1.10	.230	980	1.50/1.10	.270
1.4±0.10	4.8	242	1.60/1.30	.240	487	1.60/1.20	.220	733	1.60/1.20	.220	979	1.60/1.30	.260
1.5±0.10	4.6	242	1.70/1.40	.230	486	1.70/1.40	.210	731	1.70/1.40	.220	977	1.70/1.40	.260
1.6±0.10	4.5	241	1.80/1.50	.220	484	1.85/1.50	.210	729	2.00/1.50	.220	975	2.00/1.50	.250
1.7±0.10	4.3	240	1.90/1.60	.210	483	1.95/1.60	.200	728	2.05/1.60	.210	974	2.20/1.60	.240
1.8±0.10	4.2	239	2.00/1.70	.200	482	2.05/1.70	.190	726	2.10/1.70	.210	972	2.30/1.70	.230
1.9±0.10	4.1	239	2.10/1.80	.200	481	2.15/1.80	.190	724	2.25/1.80	.200	970	2.40/1.80	.230
2.0±0.10	4.0	238	2.20/1.90	.190	479	2.30/1.90	.180	722	2.40/1.90	.200	967	2.60/1.95	.220
2.1±0.10	3.9	237	2.30/2.00	.190	477	2.40/2.00	.170	720	2.60/2.00	.190	964	2.80/2.06	.210
2.2±0.10	3.8	236	2.40/2.10	.180	475	2.60/2.10	.170	716	2.80/2.14	.190	962	3.06/2.17	.210
2.4±0.25	3.6	235	2.85/2.15	.170	473	3.13/2.29	.170	714	3.17/2.30	.190	960	3.31/2.31	.210
2.7±0.25	3.4	233	3.19/2.45	.160	470	3.47/2.55	.150	711	3.52/2.60	.170	957	3.67/2.60	.200
3.0±0.25	3.3	231	3.51/2.75	.150	465	3.76/2.86	.140	707	3.84/2.93	.160	952	4.00/3.00	.190
3.3±0.25	3.1	229	3.83/3.05	.140	463	4.04/3.10	.140	704	4.15/3.19	.160	948	4.38/3.30	.190
3.6±0.25	3.0	228	4.16/3.35	.140	462	4.35/3.42	.130	704	4.50/3.53	.150	947	4.80/3.60	.190
3.9±0.25	2.9	227	4.48/3.65	.130	459	4.67/3.72	.120	701	4.85/3.86	.150	944	5.23/3.90	.180
4.3±0.25	2.7	223	4.91/4.05	.130	456	5.11/4.13	.120	697	5.32/4.25	.150	940	5.79/4.50	.180
4.7±0.25	2.6	220	5.35/4.45	.120	451	5.52/4.53	.110	691	5.79/4.60	.140	936	6.36/4.80	.170
5.1±0.25	2.5	218	5.78/4.85	.120	447	5.94/4.94	.110	688	6.25/5.20	.140	934	7.16/5.74	.160
5.6±0.25	2.4	215	6.00/5.35	.100	444	6.82/5.40	.100	684	7.27/5.60	.120	930	8.25/5.90	.150
6.2±0.25	2.3	212	7.00/5.95	.100	442	7.52/6.00	.100	683	8.08/6.10	.120	927	9.35/6.80	.150
6.8±0.25	2.2	208	7.20/6.55	.100	435	8.21/6.88	.100	677	8.90/6.96	.120	925	10.46/7.32	.150
7.5±0.05	2.1	206	8.64/7.00	.100	434	9.02/7.10	.100	675	9.85/7.50	.120	924	11.75/8.42	.150
8.2±0.05	2.0	203	9.40/7.70	.090	432	9.83/7.90	.080	673	10.80/8.25	.110	922	13.04/9.53	.150
9.1±0.05	1.9	199	10.37/8.60	.080	429	10.88/8.76	.080	670	12.02/9.10	.110	920	14.70/10.70	.150
10±5%	1.8	196	11.00/9.50	.080	423	11.92/9.76	.080	668	13.24/10.00	.110	918	15.37/11.80	.140
11±5%	1.8	193	12.50/10.45	.080	420	13.23/10.50	.080	665	15.07/11.00	.110	916	16.00/12.20	.140
12±5%	1.6	190	13.61/11.40	.070	418	14.50/11.90	.080	663	16.90/12.82	.110	915	N/A	.140
13±5%	1.6	187	14.75/12.35	.070	416	15.80/13.00	.080	662	18.87/14.00	.110	914	N/A	.140
14±5%	1.5	184	15.88/13.30	.070	414	17.22/14.00	.080	661	20.84/16.00	.110	913	N/A	.140
15±5%	1.5	182	17.02/14.25	.070	414	18.56/15.19	.080	660	22.62/19.13	.110	912	N/A	.130
16±5%	1.4	179	18.16/15.20	.070	411	19.90/16.28	.080	659	27.00/20.89	.100	911	N/A	.130
18±5%	1.3	176	20.42/17.10	.070	408	22.69/18.57	.070	657	33.00/22.10	.100	910	N/A	.130
20±5%	1.3	173	22.70/19.00	.060	406	25.38/20.78	.070	656	38.00/23.15	.100	908	N/A	.130
22±5%	1.2	171	24.95/20.90	.060	405	28.08/21.00	.070	655	42.00/24.00	.100	907	N/A	.130
24±5%	1.2	168	27.20/22.80	.060	403	31.31/25.61	.070	654	N/A	.090	907	N/A	.130
27±5%	1.1	165	30.78/25.69	.060	401	36.10/32.20	.070	652	N/A	.090	906	N/A	.130
30±5%	1.0	163	34.23/28.50	.050	400	40.58/33.20	.070	651	N/A	.090	905	N/A	.130
33±5%	1.0	159	37.85/31.35	.050	399	46.65/35.00	.070	650	N/A	.090	904	N/A	.120
36±5%	0.9	157	41.19/34.20	.050	397	52.22/38.00	.070	649	N/A	.090	903	N/A	.120
39±5%	0.9	155	44.79/37.05	.050	396	59.08/47.08	.070	648	N/A	.090	902	N/A	.120
43±5%	0.9	153	49.99/40.85	.050	395	70.50/53.04	.060	647	N/A	.090	901	N/A	.120
47±5%	0.8	152	55.19/44.65	.050	394	81.99/59.00	.060	646	N/A	.090	900	N/A	.110

* Other tolerances are available, see page 8

1210 Typical Electrical Tables

1

Capacitance & Tolerance* @ 1 MHz (pF)	Self Resonance Frequency (GHz)	Ref Freq. (MHz)	Effective Capacitance Max/Min (pF)	Max ESR (Ω)	Ref Freq. (MHz)	Effective Capacitance Max/Min (pF)	Max ESR (Ω)	Ref Freq. (MHz)	Effective Capacitance Max/Min (pF)	Max ESR (Ω)	Ref Freq. (MHz)	Effective Capacitance Max/Min (pF)	Max ESR (Ω)
1.0±0.25	4.98	247	1.23/0.75	.350	495	1.34/0.86	.260	745	1.46/0.94	.280	995	1.6/0.99	.350
1.2±0.25	4.55	245	1.32/0.95	.310	491	1.45/1.00	.240	739	1.64/1.1	.260	987	2.00/1.2	.320
1.5±0.25	4.07	242	1.6/1.23	.250	486	1.75/1.3	.230	731	1.82/1.95	.250	978	2.1/1.4	.270
1.8±0.25	9.71	240	2.1/1.55	.200	482	2.21/1.56	.200	731	2.4/1.6	.200	978	2.54/1.7	.210
2.2±0.25	9.96	237	2.48/1.95	.170	476	2.68/2.00	.170	727	2.85/2.1	.180	969	3.02/2.2	.200
2.7±0.25	2.70	233	3.42/2.45	.140	466	3.49/2.55	.140	708	3.73/2.63	.150	952	3.89/2.70	.170
3.3±0.25	2.60	229	4.02/3.05	.140	463	4.09/3.15	.130	704	4.33/3.23	.140	948	4.49/3.30	.160
3.6±0.25	2.50	228	4.18/3.35	.130	462	4.32/3.43	.130	704	4.50/3.32	.140	947	4.78/3.45	.160
3.9±0.25	2.40	227	4.53/3.65	.130	458	4.66/3.73	.120	701	4.85/3.75	.140	944	5.18/3.90	.150
4.3±0.25	2.30	223	5.01/4.05	.120	456	5.11/4.14	.110	697	5.32/4.29	.130	940	5.72/4.30	.140
4.7±0.25	2.20	220	5.48/4.45	.120	451	5.62/4.50	.110	691	5.94/4.60	.130	936	6.56/4.70	.140
5.1±0.25	2.10	218	5.88/4.85	.110	447	6.04/4.90	.110	683	6.36/5.10	.130	933	7.20/5.40	.140
5.6±0.25	2.00	215	6.49/5.35	.110	441	6.72/5.56	.100	681	7.17/5.67	.120	928	8.15/6.00	.140
6.2±0.25	1.90	212	7.19/5.95	.100	442	7.26/6.07	.100	679	7.99/6.10	.110	927	9.18/7.00	.130
6.8±0.25	1.80	208	7.38/6.55	.100	435	8.16/6.42	.100	677	8.81/6.93	.110	925	10.20/7.42	.130
7.5±0.25	1.70	206	8.60/7.90	.100	434	8.90/7.25	.100	675	9.58/7.60	.100	924	11.36/8.00	.130
8.2±0.25	1.70	203	9.36/7.70	.100	432	9.76/7.96	.090	673	10.68/8.31	.100	922	13.00/9.10	.130
9.1±0.25	1.60	199	10.34/8.60	.090	429	10.87/8.88	.090	670	12.10/9.66	.090	920	15.11/10.25	.130
10±5%	1.50	196	11.33/9.50	.090	423	11.97/9.79	.090	668	13.51/10.05	.090	918	17.22/11.06	.130
11±5%	1.50	193	12.50/10.45	.090	420	13.23/10.83	.090	665	15.07/11.33	.090	916	N/A	.130
12±5%	1.40	190	13.61/11.40	.080	418	14.59/11.90	.080	663	16.90/12.82	.090	915	N/A	.120
13±5%	1.30	185	14.75/12.35	.080	416	15.64/13.00	.080	662	18.80/13.60	.090	914	N/A	.120
14±5%	1.30	183	15.89/13.30	.080	415	17.22/14.00	.080	661	20.85/16.00	.090	913	N/A	.120
15±5%	1.20	182	17.02/14.25	.080	414	18.56/15.19	.080	660	22.62/17.00	.090	912	N/A	.110
16±5%	1.20	180	18.16/15.20	.080	411	19.90/16.28	.080	659	25.12/18.00	.090	911	N/A	.110
18±5%	1.10	176	20.42/17.10	.070	408	22.69/18.57	.080	657	30.00/24.00	.080	909	N/A	.110
20±5%	1.10	173	22.70/19.00	.070	406	25.36/20.78	.080	656	35.00/26.00	.080	908	N/A	.110
22±5%	1.00	171	24.95/20.90	.070	405	28.06/22.96	.080	655	42.00/27.00	.080	908	N/A	.110
24±5%	0.98	168	27.20/22.60	.070	403	31.31/25.60	.080	654	N/A	.080	907	N/A	.110
25±5%	0.96	166	26.39/23.75	.070	402	32.91/26.00	.080	653	N/A	.080	907	N/A	.110
27±5%	0.92	164	30.78/25.65	.070	401	36.10/28.00	.070	652	N/A	.080	906	N/A	.110
28±5%	0.91	163	31.93/26.50	.070	401	37.60/30.76	.070	651	N/A	.080	906	N/A	.110
30±5%	0.88	162	34.23/28.50	.070	400	40.50/33.20	.070	651	N/A	.080	905	N/A	.110
32±5%	0.85	161	36.51/30.40	.070	399	44.63/34.50	.070	650	N/A	.080	905	N/A	.110
33±5%	0.84	159	37.65/31.35	.060	399	46.65/35.00	.070	650	N/A	.080	905	N/A	.110
34±5%	0.82	158	38.83/32.30	.060	398	48.51/37.00	.070	649	N/A	.080	904	N/A	.110
36±5%	0.80	157	41.20/34.20	.060	397	52.22/41.00	.070	649	N/A	.070	904	N/A	.110
39±5%	0.77	155	44.79/37.05	.060	396	59.00/43.00	.070	649	N/A	.070	904	N/A	.110
43±5%	0.73	153	49.99/40.85	.060	396	70.00/46.00	.070	648	N/A	.070	904	N/A	.110
47±5%	0.70	152	55.69/44.65	.060	395	81.00/53.00	.070	648	N/A	.070	903	N/A	.110

* Other tolerances are available, see page 8

Typical ESR vs. Frequency
Accu-P[®] 0201

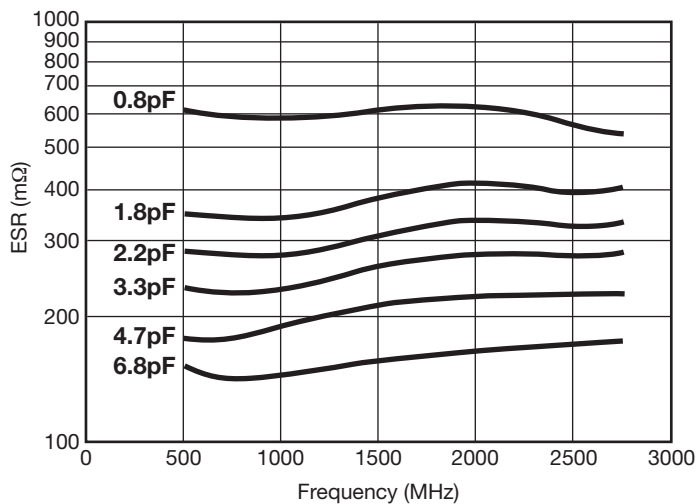

Typical SRF vs. Capacitance
Accu-P[®] 0201

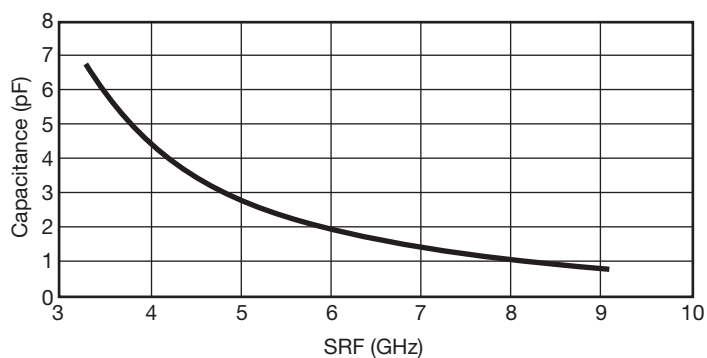

Typical Q vs. Frequency
Accu-P[®] 0201

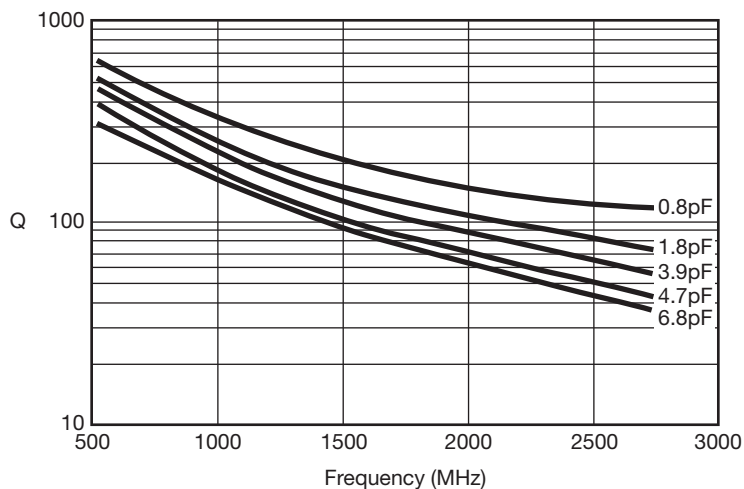

Accu-F® / Accu-P®

High Frequency Characteristics



1

Typical ESR vs. Frequency
Accu-P® 0402

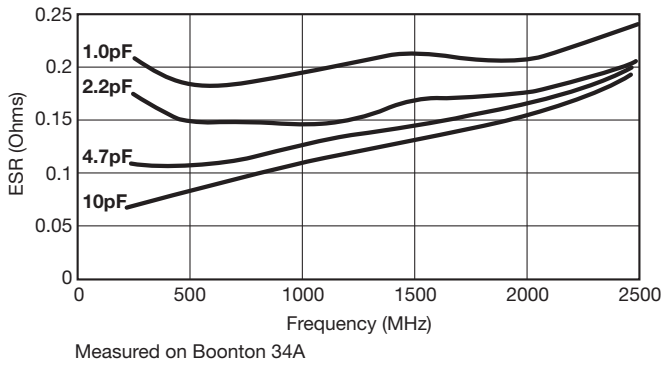

Typical ESR vs. Frequency
Accu-F®/Accu-P® 0603

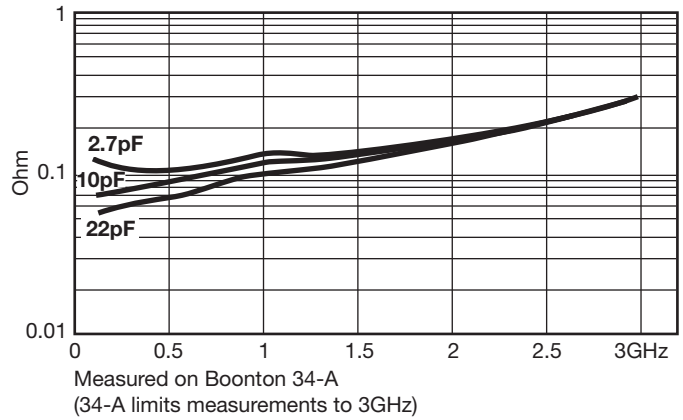

Typical Q vs. Frequency
Accu-P® 0402

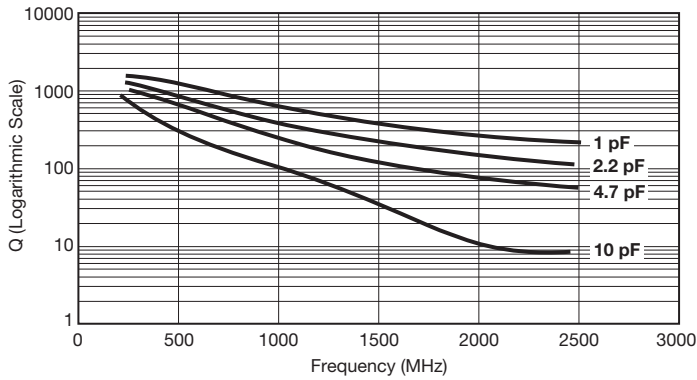

Typical Q vs. Frequency
Accu-F®/Accu-P® 0603

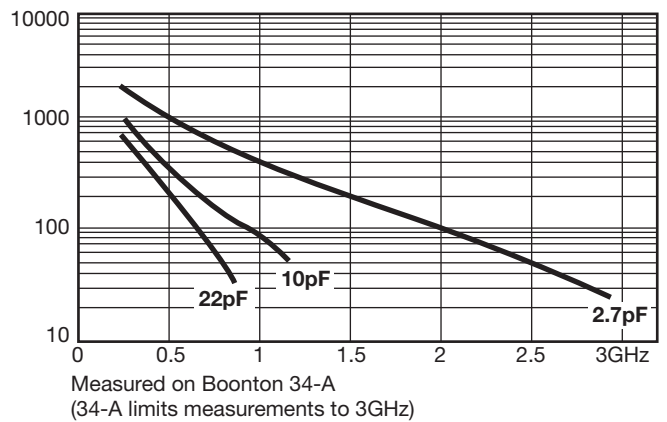

Typical Self Resonant Frequency vs. Capacitance
Accu-P® 0402

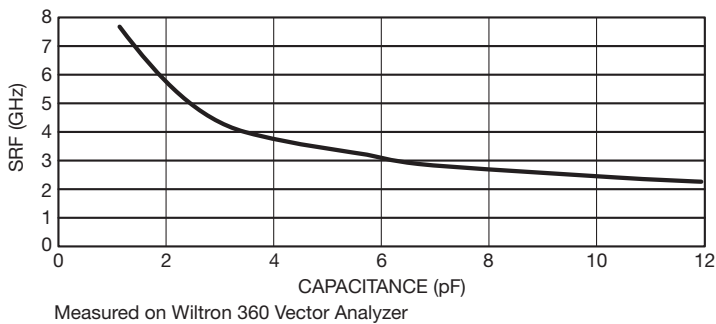

Typical Self Resonant Frequency vs. Capacitance
Accu-F®/Accu-P® 0603

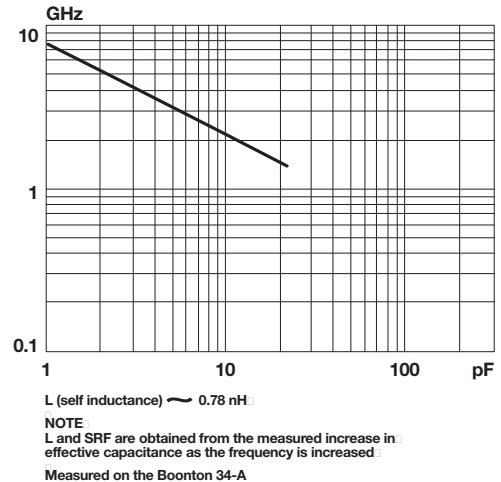

Accu-F® / Accu-P®

High Frequency Characteristics



1

Typical ESR vs. Frequency
Accu-F®/Accu-P® 0805

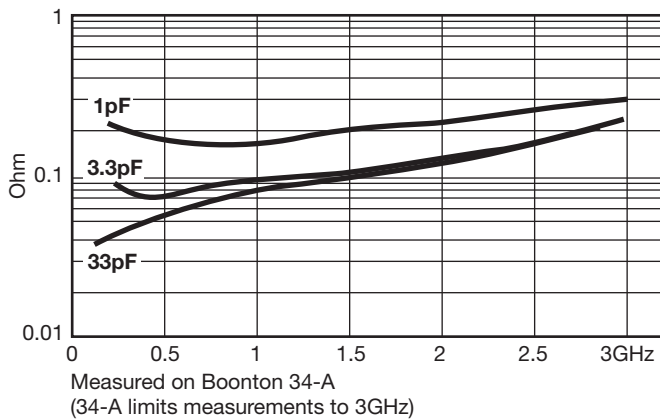

Typical ESR vs. Frequency
Accu-P® 1210

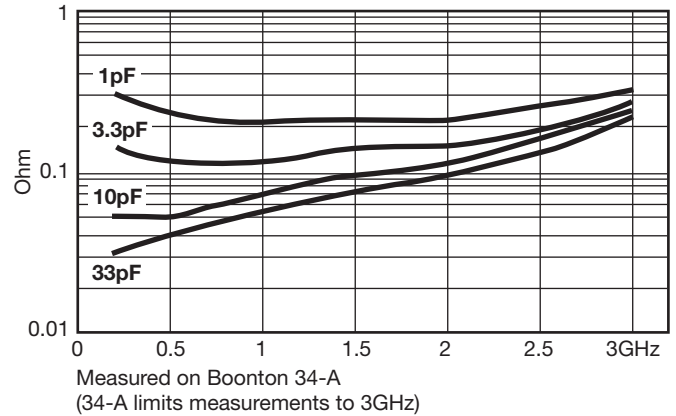

Typical Q vs. Frequency
Accu-F®/Accu-P® 0805

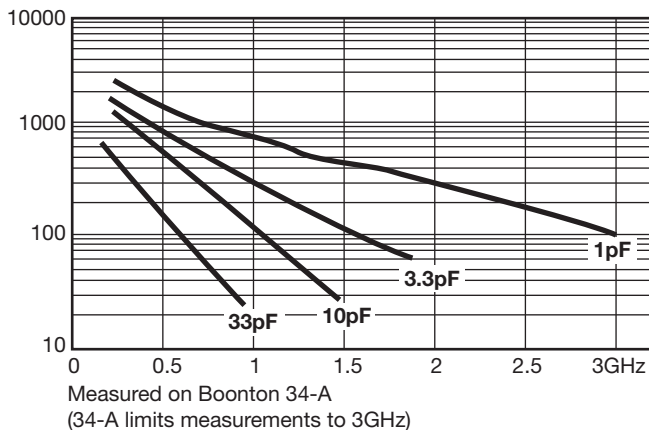

Typical Q vs. Frequency
Accu-P® 1210

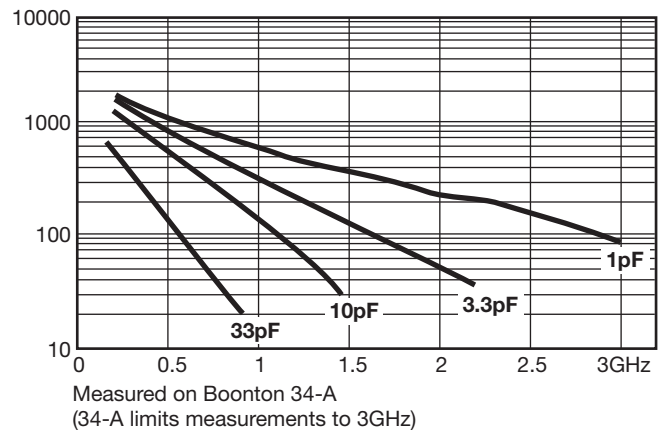

Typical Self Resonant Frequency vs. Capacitance
Accu-F®/Accu-P® 0805

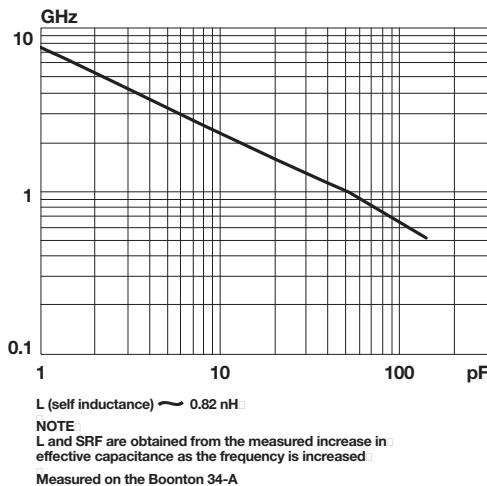

Typical Self Resonant Frequency vs. Capacitance
Accu-P® 1210

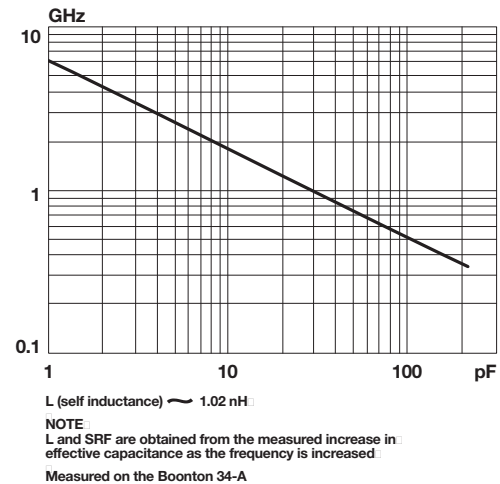

Environmental / Mechanical Characteristics

ENVIRONMENTAL CHARACTERISTICS

TEST	CONDITIONS	REQUIREMENT
Life (Endurance) MIL-STD-202F Method 108A	125°C, 2U _R , 1000 hours	No visible damage $\Delta C/C \leq 2\%$ for C \geq 5pF $\Delta C \leq 0.25\text{pF}$ for C<5pF
Accelerated Damp Heat Steady State MIL-STD-202F Method 103B	85°C, 85% RH, U _R , 1000 hours	No visible damage $\Delta C/C \leq 2\%$ for C \geq 5pF $\Delta C \leq 0.25\text{pF}$ for C<5pF
Temperature Cycling MIL-STD-202F Method 107E MIL-STD-883D Method 1010.7	-55°C to +125°C, 15 cycles – Accu-P® -55°C to +125°C, 5 cycles – Accu-F®	No visible damage $\Delta C/C \leq 2\%$ for C \geq 5pF $\Delta C \leq 0.25\text{pF}$ for C<5pF
Resistance to Solder Heat IEC-68-2-58	260°C \pm 5°C for 10 secs	C remains within initial limits

MECHANICAL CHARACTERISTICS

TEST	CONDITIONS	REQUIREMENT
Solderability IEC-68-2-58	Components completely immersed in a solder bath at 235°C for 2 secs.	Terminations to be well tinned, minimum 95% coverage
Leach Resistance IEC-68-2-58	Components completely immersed in a solder bath at 260 \pm 5°C for 60 secs.	Dissolution of termination faces \leq 15% of area Dissolution of termination edges \leq 25% of length
Adhesion MIL-STD-202F Method 211A	A force of 5N applied for 10 secs.	No visible damage
Termination Bond Strength IEC-68-2-21 Amend. 2	Tested as shown in diagram D = 3mm Accu-P D = 1mm Accu-F	No visible damage $\Delta C/C \leq 2\%$ for C \geq 5pF $\Delta C \leq 0.25\text{pF}$ for C<5pF
Robustness of Termination IEC-68-2-21 Amend. 2	A force of 5N applied for 10 secs.	No visible damage
High Frequency Vibration MIL-STD-202F Method 201A, 204D (Accu-P® only)	55Hz to 2000Hz, 20G	No visible damage
Storage	12 months minimum with components stored in “as received” packaging	Good solderability

QUALITY & RELIABILITY

Accu-P® is based on well established thin-film technology and materials.

• ON-LINE PROCESS CONTROL

This program forms an integral part of the production cycle and acts as a feedback system to regulate and control production processes. The test procedures, which are integrated into the production process, were developed after long research work and are based on the highly developed semiconductor industry test procedures and equipment. These measures help AVX to produce a consistent and high yield line of products.

• FINAL QUALITY INSPECTION

Finished parts are tested for standard electrical parameters and visual/mechanical characteristics. Each production lot is 100% evaluated for: capacitance and proof voltage at 2.5 U_R. In addition, production is periodically evaluated for:

Average capacitance with histogram printout for capacitance distribution;
IR and Breakdown Voltage distribution;
Temperature Coefficient;
Solderability;
Dimensional, mechanical and temperature stability.

QUALITY ASSURANCE

The reliability of these thin-film chip capacitors has been studied intensively for several years. Various measures have been taken to obtain the high reliability required today by the industry. Quality assurance policy is based on well established international industry standards. The reliability of the capacitors is determined by accelerated testing under the following conditions:

Life (Endurance)	125°C, 2U _R , 1000 hours
Accelerated Damp Heat Steady State	85°C, 85% RH, U _R , 1000 hours.

Performance Characteristics RF Power Applications

RF POWER APPLICATIONS

In RF power applications capacitor losses generate heat. Two factors of particular importance to designers are:

- Minimizing the generation of heat.
- Dissipating heat as efficiently as possible.

CAPACITOR HEATING

- The major source of heat generation in a capacitor in RF power applications is a function of RF current (I) and ESR, from the relationship:

$$\text{Power dissipation} = I_{\text{RMS}}^2 \times \text{ESR}$$

- Accu-P® capacitors are specially designed to minimize

ESR and therefore RF heating. Values of ESR for Accu-P® capacitors are significantly less than those of ceramic MLC components currently available.

HEAT DISSIPATION

- Heat is dissipated from a capacitor through a variety of paths, but the key factor in the removal of heat is the thermal conductivity of the capacitor material.
- The higher the thermal conductivity of the capacitor, the more rapidly heat will be dissipated.
- The table below illustrates the importance of thermal conductivity to the performance of Accu-P® in power applications.



PRODUCT	MATERIAL	THERMAL CONDUCTIVITY W/mK
Accu-P®	Alumina	18.9
Microwave MLC	Magnesium Titanate	6.0

**Power Handling
Accu-P® 10pF**

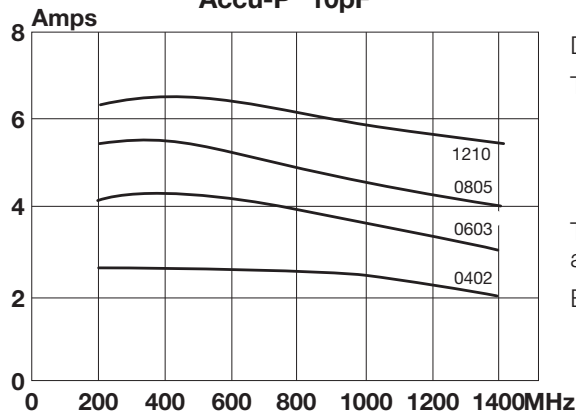

Data used in calculating the graph:

Thermal impedance of capacitors:

0402	17°C/W
0603	12°C/W
0805	6.5°C/W
1210	5°C/W

Thermal impedance measured using RF generator, amplifier and strip-line transformer.

ESR of capacitors measured on Boonton 34A

THERMAL IMPEDANCE

Thermal impedance of Accu-P® chips is shown below compared with the thermal impedance of Microwave MLC's.

CAPACITOR TYPE	CHIP SIZE	THERMAL IMPEDANCE (°C/W)
Accu-P®	0805	6.5
	1210	5
Microwave MLC	0505	12
	1210	7.5

The thermal impedance expresses the temperature difference in °C between chip center and termination caused by a power dissipation of 1 watt in the chip. It is expressed in °C/W.

ADVANTAGES OF ACCU-P® IN RF POWER CIRCUITS

The optimized design of Accu-P® offers the designer of RF power circuits the following advantages:

- Reduced power losses due to the inherently low ESR of Accu-P®.
- Increased power dissipation due to the high thermal conductivity of Accu-P®.

• THE ONLY TRUE TEST OF A CAPACITOR IN ANY PARTICULAR APPLICATION IS ITS PERFORMANCE UNDER OPERATING CONDITIONS IN THE ACTUAL CIRCUIT.

PRACTICAL APPLICATION IN RF POWER CIRCUITS

- There is a wide variety of different experimental methods for measuring the power handling performance of a capacitor in RF power circuits. Each method has its own problems and few of them exactly reproduce the conditions present in "real" circuit applications.
- Similarly, there is a very wide range of different circuit applications, all with their unique characteristics and operating conditions which cannot possibly be covered by such "theoretical" testing.

Application Notes

GENERAL

Accu-F® and Accu-P® SMD capacitors are designed for soldering to printed circuit boards or other substrates. The construction of the components is such that they will withstand the time/temperature profiles used in both wave and reflow soldering methods.

1

CIRCUIT BOARD TYPE

The circuit board types which may be used with Accu-F® and Accu-P® are as follows:

Accu-F®: All flexible types of circuit boards (eg. FR-4, G-10).

Accu-P®: All flexible types of circuit boards (eg. FR-4, G-10) and also alumina.

For other circuit board materials, please consult factory.

HANDLING

SMD capacitors should be handled with care to avoid damage or contamination from perspiration and skin oils. The use of plastic tipped tweezers or vacuum pick-ups is strongly recommended for individual components. Bulk handling should ensure that abrasion and mechanical shock are minimized. For automatic equipment, taped and reeled product gives the ideal medium for direct presentation to the placement machine.

COMPONENT PAD DESIGN

Component pads must be designed to achieve good joints and minimize component movement during reflow soldering. Pad designs are given below for both wave and reflow soldering.

The basis of these designs is:

- Pad width equal to component width. It is permissible to decrease this to as low as 85% of component width but it is not advisable to go below this.
- Pad overlap 0.5mm beneath large components. Pad overlap about 0.3mm beneath small components.
- Pad extension of 0.5mm for reflow of large components and pad extension about 0.3mm for reflow of small components. Pad extension about 1.0mm for wave soldering.

WAVE SOLDERING

DIMENSIONS: millimeters (inches)

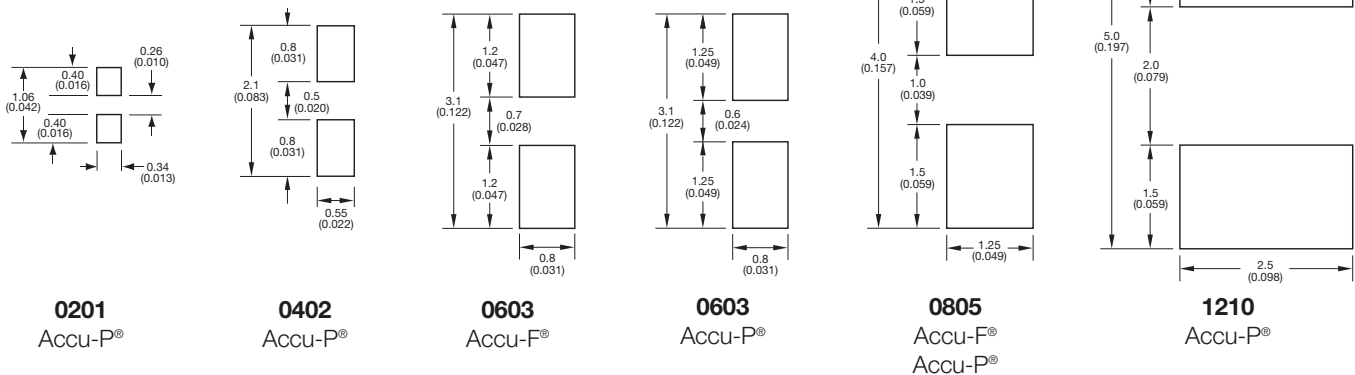

REFLOW SOLDERING

DIMENSIONS: millimeters (inches)

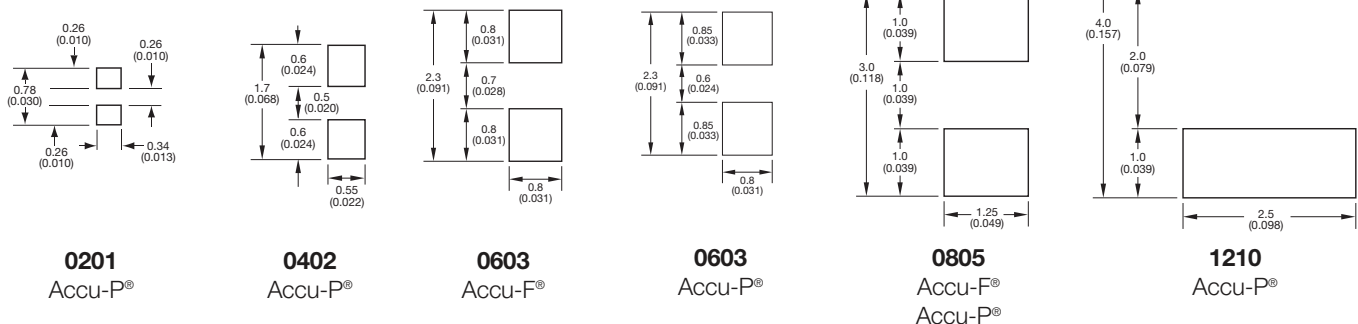

Application Notes

PREHEAT & SOLDERING

The rate of preheat in production should not exceed 4°C/second and a recommended maximum is about 2°C/second. Temperature differential from preheat to soldering should not exceed 100°C.

For further specific application or process advice, please consult AVX.

COOLING

After soldering, the assembly should preferably be allowed to cool naturally. In the event of assisted cooling, similar conditions to those recommended for preheating should be used.

HAND SOLDERING & REWORK

Hand soldering is permissible. Preheat of the PCB to 150°C is required. The most preferable technique is to use hot air soldering tools. Where a soldering iron is used, a temperature controlled model not exceeding 30 watts should be used and set to not more than 260°C.

RECOMMENDED SOLDERING PROFILE

IR REFLOW

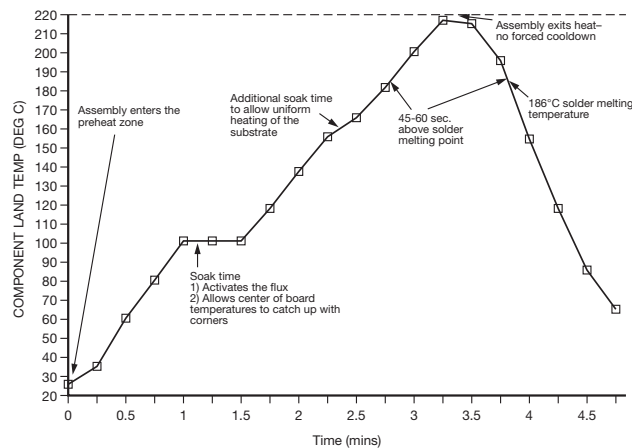

VAPOR PHASE

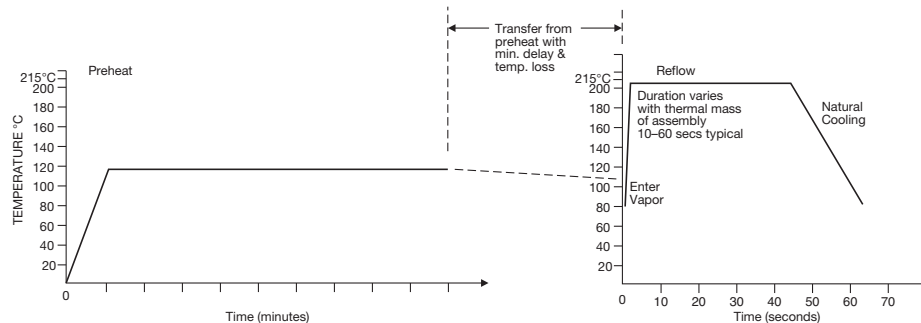

CLEANING RECOMMENDATIONS

Care should be taken to ensure that the devices are thoroughly cleaned of flux residues, especially the space beneath the device. Such residues may otherwise become conductive and effectively offer a lossy bypass to the device. Various recommended cleaning conditions (which must be optimized for the flux system being used) are as follows:

Cleaning liquids. i-propanol, ethanol, acetylacetone, water and other standard PCB cleaning liquids.

Ultrasonic conditions . . power-20w/liter max. frequency-20kHz to 45kHz.

Temperature 80°C maximum (if not otherwise limited by chosen solvent system).

Time 5 minutes max.

STORAGE CONDITIONS

Recommended storage conditions for Accu-F® and Accu-P® prior to use are as follows:

Temperature 15°C to 35°C

Humidity ≤65%

Air Pressure 860mbar to 1060mbar

WAVE SOLDERING

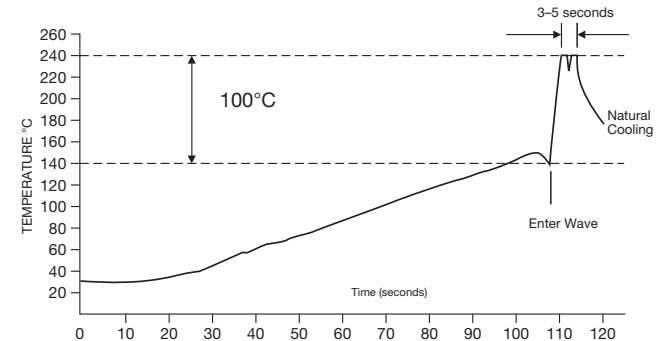

Automatic Insertion Packaging

TAPE & REEL

All tape and reel specifications are in compliance with EIA 481-1-A.
(equivalent to IEC 286 part 3).

- 8mm carrier
- Reeled quantities: Reels of 3,000 per 7" reel or 10,000 pieces per 13" reel
0201 and 0402 = 5,000 pieces per 7" reel and 20,000 pieces per 13" reel

1

REEL

DIMENSIONS: millimeters (inches)

A ⁽¹⁾	B	C	D	E	F	G
180±1.0 (7.087±0.039)	1.5 min. (0.059 min.)	13±0.2 (0.512 ± 0.008)	20.2 min. (0.795 min.)	50 min. (1.969 min.)	9.6±1.5 (0.370 ± 0.050)	14.4 max. (0.567 max.)

Metric dimensions will govern.
Inch measurements rounded and for reference only.

(1) 330mm (13 inch) reels are available.

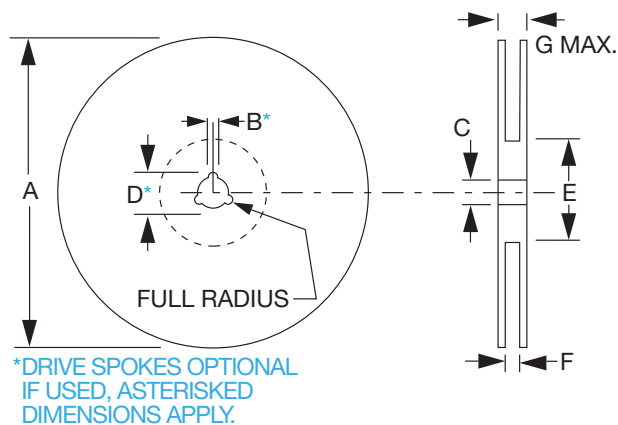

CARRIER

DIMENSIONS: millimeters (inches)

A	B	C	D	E	F
8.0 ± 0.3 (0.315 ± 0.012)	3.5 ± 0.05 (0.138 ± 0.002)	1.75±0.1 (0.069 ± 0.004)	2.0 ± 0.05 (0.079 ± 0.002)	4.0 ± 0.1 (0.157 ± 0.004)	1.5 ^{+0.1} _{-0.0} (0.059 ^{+0.004} _{-0.000})

NOTE: The nominal dimensions of the component compartment (W,L) are derived from the component size.

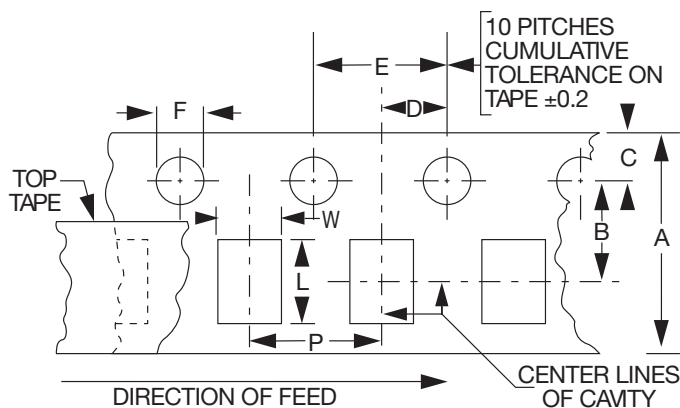

P = 4mm except 0201 and 0402 where P = 2mm

NOTE: AVX reserves the right to change the information published herein without notice.

AVX RF

Thin-Film Technology

2

Accu-L[®]

Thin-Film RF/Microwave Inductors

L0402 Tight Tolerance



RF Inductor

GENERAL DESCRIPTION ITF TECHNOLOGY

The L0402 LGA Inductor is based on thin-film multilayer technology. The technology provides a miniature part with excellent high frequency performance and rugged construction for reliable automatic assembly.

APPLICATIONS

- Mobile Communications
- Satellite TV Receivers
- GPS
- Vehicle Location Systems
- Wireless LAN's
- Filters
- Matching Networks

LAND GRID ARRAY ADVANTAGES

- Inherent Low Profile
- Self Alignment during Reflow
- Excellent Solderability
- Low Parasitics
- Better Heat Dissipation

DIMENSIONS: (Bottom View)

millimeters (inches)

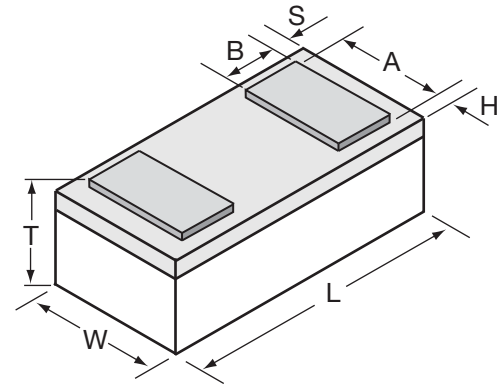

L	1.00±0.10 (0.039±0.004)
W	0.58±0.07 (0.023±0.003)
T	0.35±0.10 (0.014±0.004)

A	0.48±0.05 (0.019±0.002)
B	0.17±0.05 (0.007±0.002)
S	0.064±0.05 (0.003±0.002)



2

HOW TO ORDER



P/N Example: L04023R3BHNTTR

QUALITY INSPECTION

Finished parts are 100% tested for electrical parameters and visual characteristics. Each production lot is evaluated on a sample basis for:

- Static Humidity: 85°C, 85% RH, 160 hours
- Endurance: 125°C, I_R, 4 hours

TERMINATION

Nickel/Lead Free solder coating compatible with automatic soldering technologies: reflow, wave soldering, vapor phase and manual.

MAKING AND ORIENTATION IN TAPE

(Top View)

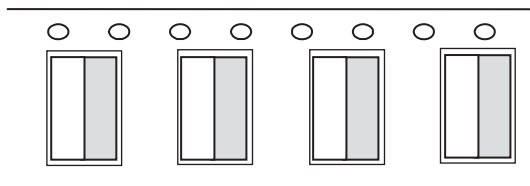

Recommended Pad Layout Dimensions mm (inches)

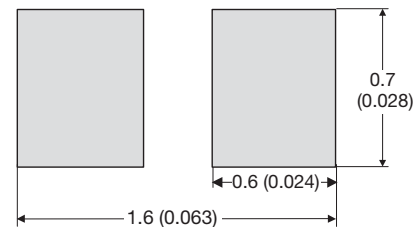

L0402 Tight Tolerance

RF Inductor



ELECTRICAL SPECIFICATIONS

L(nH)	450MHz			900MHz	1900MHz	2400MHz	SRF min. (MHz)	R _{dc} max. (Ω)	I _{dc} max. (mA)
	Tolerance A=±0.05nH, B=±0.1nH, C=±0.2nH, D=±0.5nH	Q (min)	Q (Typ)	Q (Typ)	Q (Typ)	Q (Typ)			
0.82	± 0.05nH, ± 0.1nH	25	40	50	60	70	20000	0.06	500
1.0	± 0.05nH, ± 0.1nH	20	30	35	40	50	20000	0.15	500
1.2	± 0.05nH, ± 0.1nH, ± 0.2nH	20	30	30	40	45	20000	0.20	400
1.5	± 0.05nH, ± 0.1nH, ± 0.2nH	20	25	30	40	40	18000	0.20	400
1.8	± 0.05nH, ± 0.1nH, ± 0.2nH	18	20	30	35	40	16000	0.20	400
2.2	± 0.05nH, ± 0.1nH, ± 0.2nH	15	20	25	35	40	15000	0.20	400
2.7	± 0.05nH, ± 0.1nH, ± 0.2nH	15	20	25	35	40	9500	0.25	250
3.3	± 0.1nH, ± 0.2nH, ± 0.5nH	15	20	25	35	40	8500	0.40	250
3.9	± 0.1nH, ± 0.2nH, ± 0.5nH	13	20	20	30	30	8000	0.45	250
4.7	± 0.1nH, ± 0.2nH, ± 0.5nH	13	20	20	30	30	7500	0.45	250
5.6	± 0.1nH, ± 0.2nH, ± 0.5nH	13	20	20	30	30	7000	0.65	200
6.8	± 0.1nH, ± 0.2nH, ± 0.5nH	12	15	20	25	30	6500	0.90	200

Please contact factory for intermediate inductance values within the indicated range.

2

2



10 nH Inductor (Top View)

ACCU-L[®] TECHNOLOGY

The Accu-L[®] SMD Inductor is based on thin-film multilayer technology. This technology provides a level of control on the electrical and physical characteristics of the component which gives consistent characteristics within a lot and lot-to-lot.

The original design provides small size, excellent high-frequency performance and rugged construction for reliable automatic assembly.

The Accu-L[®] inductor is particularly suited for the telecommunications industry where there is a continuing trend towards miniaturization and increasing frequencies. The Accu-L[®] inductor meets both the performance and tolerance requirements of present cellular frequencies 450MHz and 900MHz and of future frequencies, such as 1700MHz, 1900MHz and 2400MHz.

FEATURES

- High Q
- RF Power Capability
- High SRF
- Low DC Resistance
- Ultra-Tight Tolerance on Inductance
- Standard 0603 and 0805 Chip Size
- Low Profile
- Rugged Construction
- Taped and Reeled

APPLICATIONS

- Mobile Communications
- Satellite TV Receivers
- GPS
- Vehicle Locations Systems
- Filters
- Matching Networks

DIMENSIONS: millimeters (inches)

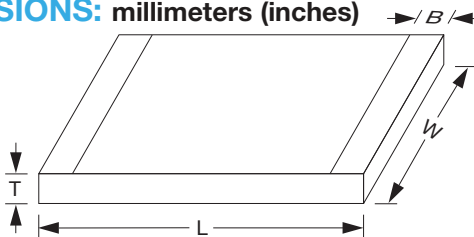

	0603	0805
L	1.6±0.10 (0.063±0.004)	2.11±0.10 (0.083±0.004)
W	0.81±0.10 (0.032±0.004)	1.5±0.10 (0.059±0.004)
T	0.61±0.10 (0.024±0.004)	0.91±0.13 (0.036±0.005)
B	top: 0.0 +0.3/-0.0 (0.0+0.012) bottom: 0.35±0.20 (0.014±0.008)	0.25±0.15 (0.010±0.006)

Operating/Storage
Temp. Range:
-55°C to +125°C

Accu-L[®] 0603 and 0805



SMD High-Q RF Inductor

HOW TO ORDER

L	0805	4R7	D	E	S	TR
Product Inductor	Size 0603 0805	Inductance Expressed in nH (2 significant digits + number of zeros) for values <10nH, letter R denotes decimal point. Example: 22nH = 220 4.7nH = 4R7	Tolerance for L ≤ 4.7nH, B = ±0.1nH C = ±0.2nH D = ±0.5nH 4.7nH < L < 10nH, C = ±0.2nH D = ±0.5nH L ≥ 10nH, G = ±2% J = ±5%	Specification Code E = Accu-L [®] 0805 technology G = Accu-L [®] 0603 technology	Termination Code W = Nickel/ solder coated (Sn 63, Pb 37) **S = Nickel/ Lead Free Solder coated (Sn100)	Packaging Code TR = Tape and Reel (3,000/reel)



Please select correct termination style

Engineering Kits Available
see pages 90-91

2

ELECTRICAL SPECIFICATIONS TABLE FOR ACCU-L[®] 0603

450 MHz Test Frequency			900 MHz Test Frequency		1900 MHz Test Frequency		2400 MHz Test Frequency		SRF min (MHz)	R _{DC} max (Ω)	I _{DC} max (mA)
Inductance L (nH)	Available Inductance Tolerance	Q Typical	L (nH)	Q Typical	L (nH)	Q Typical	L (nH)	Q Typical			
1.2	±0.1, ±0.2nH	49	1.2	70	1.2	134	1.2	170	10000	0.04	1000
1.5	±0.1, ±0.2nH	26	1.54	39	1.52	63	1.52	76	10000	0.06	1000
1.8	±0.1, ±0.2nH	20	1.74	30	1.73	50	1.72	59	10000	0.07	1000
2.2	±0.1, ±0.2nH	20	2.2	30	2.24	49	2.24	56	10000	0.08	1000
2.7	±0.1, ±0.2nH	21	2.7	30	2.75	48	2.79	54	9000	0.08	750
3.3	±0.1, ±0.2, ±0.5nH	24	3.33	35	3.39	56	3.47	64	8400	0.08	750
3.9	±0.1, ±0.2, ±0.5nH	25	3.9	57	4.06	60	4.21	69	6500	0.12	500
4.7	±0.1, ±0.2, ±0.5nH	23	4.68	32	4.92	46	5.2	49	5500	0.15	500
5.6	±0.2, ±0.5nH	26	5.65	36	5.94	54	6.23	60	5000	0.25	300
6.8	±0.2, ±0.5nH	23	6.9	33	7.3	47	8.1	39	4500	0.30	300
8.2	±0.2, ±0.5nH	23	8.4	31	10	35	12.1	31	3800	0.35	300
10.0	±2%, ±5%	28	10	39	11.8	47	14.1	41	3500	0.45	300
12.0	±2%, ±5%	28	13.2	38	14.1	30	17.2	20	3000	0.50	300
15.0	±2%, ±5%	28	16.2	38	25.9	30	49.8	15	2500	0.60	300

(1) I_{DC} measured for 15°C rise at 25°C ambient temperature when soldered to FR-4 board.

Inductance and Q measured on Agilent 4291B / 4287 using the 16196A test fixture.

ELECTRICAL SPECIFICATIONS TABLE FOR ACCU-L[®] 0805

450 MHz Test Frequency			900 MHz Test Frequency		1700 MHz Test Frequency		2400 MHz Test Frequency		SRF min (MHz)	R _{DC} max (Ω)	I _{DC} max (mA)	
Inductance L (nH)	Available Inductance Tolerance	Q Typical	L (nH)	Q Typical	L (nH)	Q Typical	L (nH)	Q Typical			ΔT = 15°C (1)	ΔT = 70°C (2)
1.2	±0.1nH, ±0.2nH, ±0.5nH	60	1.2	92	1.2	122	1.2	92	10000	0.05	1000	2000
1.5	±0.1nH, ±0.2nH, ±0.5nH	50	1.5	74	1.5	102	1.5	84	10000	0.05	1000	2000
1.8	±0.1nH, ±0.2nH, ±0.5nH	50	1.8	72	1.8	88	1.9	73	10000	0.06	1000	2000
2.2	±0.1nH, ±0.2nH, ±0.5nH	42	2.2	62	2.2	82	2.3	72	10000	0.07	1000	2000
2.7	±0.1nH, ±0.2nH, ±0.5nH	42	2.7	62	2.8	80	2.9	70	10000	0.08	1000	2000
3.3	±0.1nH, ±0.2nH, ±0.5nH	38	3.3	46	3.4	48	3.5	57	10000	0.11	750	1500
3.9	±0.1nH, ±0.2nH, ±0.5nH	27	3.9	36	4.0	38	4.1	42	10000	0.20	750	1500
4.7	±0.1nH, ±0.2nH, ±0.5nH	43	4.8	62	5.3	76	5.8	60	5500	0.10	750	1500
5.6	±0.5nH	50	5.7	68	6.3	73	7.6	62	4600	0.10	750	1500
6.8	±0.5nH	43	7.0	62	7.7	71	9.4	50	4500	0.11	750	1500
8.2	±0.5nH	43	8.5	56	10.0	55	15.2	32	3500	0.12	750	1500
10	±2%, ±5%	46	10.6	60	13.4	52	-	-	2500	0.13	750	1500
12	±2%, ±5%	40	12.9	50	17.3	40	-	-	2400	0.20	750	1500
15	±2%, ±5%	36	16.7	46	27	23	-	-	2200	0.20	750	1000
18	±2%, ±5%	30	21.9	27	-	-	-	-	1700	0.35	500	1000
22	±2%, ±5%	36	27.5	33	-	-	-	-	1400	0.40	500	1000

(1) I_{DC} measured for 15°C rise at 25°C ambient temperature

(2) I_{DC} measured for 70°C rise at 25°C ambient temperature

L, Q, SRF measured on HP 4291A, Boonton 34A and Wiltron 360 Vector Analyzer, R_{DC} measured on Keithley 580 micro-ohmmeter.



Accu-L[®] 0603 and 0805



SMD High-Q RF Inductor

L0603

Typical Q vs. Frequency
L0603

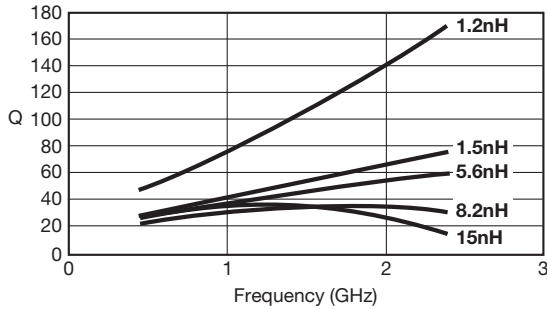

Measured on AGILENT 4291B/4287
using the 16196A test fixture

Typical Inductance vs. Frequency
L0603

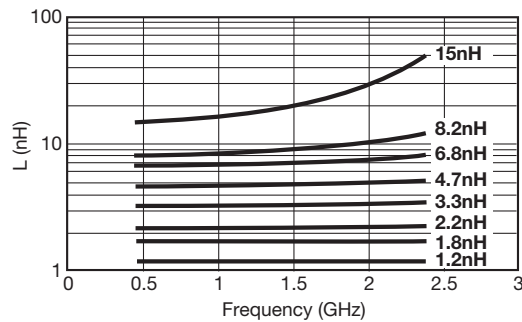

Measured on AGILENT 4291B/4287
using the 16196A test fixture

L0805

Typical Q vs. Frequency
L0805

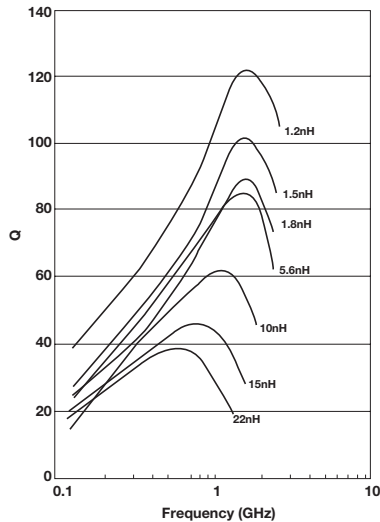

Measured on HP4291A and
Boonton 34A Coaxial Line

Typical Inductance vs. Frequency
L0805

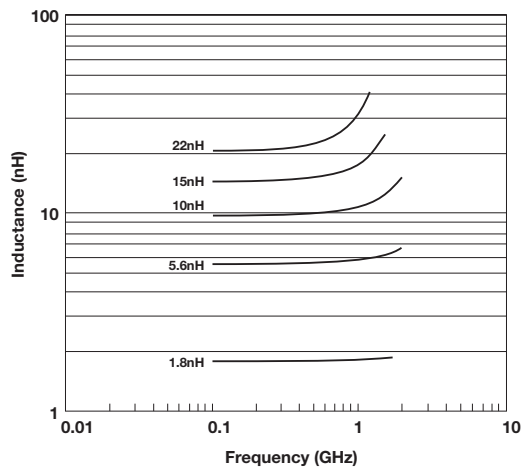

Measured on HP4291A and
Wiltron 360 Vector Analyzer

Maximum Temperature Rise
at 25°C ambient temperature (on FR-4)
L0805

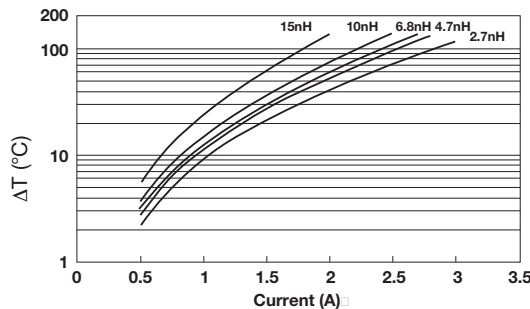

Temperature rise will typically be no higher than shown by the graph



Accu-L[®] 0603 and 0805



SMD High-Q RF Inductor

FINAL QUALITY INSPECTION

Finished parts are tested for electrical parameters and visual/mechanical characteristics.

Parts are 100% tested for inductance at 450MHz. Parts are 100% tested for R_{DC}. Each production lot is evaluated on a sample basis for:

- Q at test frequency
- Static Humidity Resistance: 85°C, 85% RH, 160 hours
- Endurance: 125°C, I_R, 4 hours

2

ENVIRONMENTAL CHARACTERISTICS

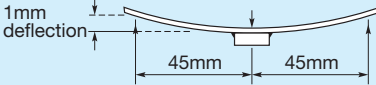
TEST	CONDITIONS	REQUIREMENT
Solderability	Components completely immersed in a solder bath at 235 ± 5°C for 2 secs.	Terminations to be well tinned. No visible damage.
Leach Resistance	Components completely immersed in a solder bath at 260 ± 5°C for 60 secs.	Dissolution of termination faces ≤ 15% of area. Dissolution of termination edges ≤ 25% of length.
Storage	12 months minimum with components stored in "as received" packaging.	Good solderability
Shear	Components mounted to a substrate. A force of 5N applied normal to the line joining the terminations and in a line parallel to the substrate.	No visible damage
Rapid Change of Temperature	Components mounted to a substrate. 5 cycles -55°C to +125°C.	No visible damage
Bend Strength	Tested as shown in diagram 	No visible damage
Temperature Coefficient of Inductance (TCL)	Component placed in environmental chamber -55°C to +125°C.	+0 to +125 ppm/°C (typical) $TCL = \frac{L_2 - L_1}{L_1 (T_2 - T_1)} \cdot 10^6$ T ₁ = 25°C

Application Notes

HANDLING

SMD chips should be handled with care to avoid damage or contamination from perspiration and skin oils. The use of plastic tipped tweezers or vacuum pick-ups is strongly recommended for individual components. Bulk handling should ensure that abrasion and mechanical shock are minimized. For automatic equipment, taped and reeled product is the ideal medium for direct presentation to the placement machine.

CIRCUIT BOARD TYPE

All flexible types of circuit boards may be used (e.g. FR-4, G-10) and also alumina.

For other circuit board materials, please consult factory.

COMPONENT PAD DESIGN

Component pads must be designed to achieve good joints and minimize component movement during soldering.

Pad designs are given below for both wave and reflow soldering.

The basis of these designs is:

- Pad width equal to component width. It is permissible to decrease this to as low as 85% of component width but it is not advisable to go below this.
- Pad overlap about 0.3mm.
- Pad extension about 0.3mm for reflow.
Pad extension about 0.8mm for wave soldering.

WAVE SOLDERING

DIMENSIONS: millimeters (inches)

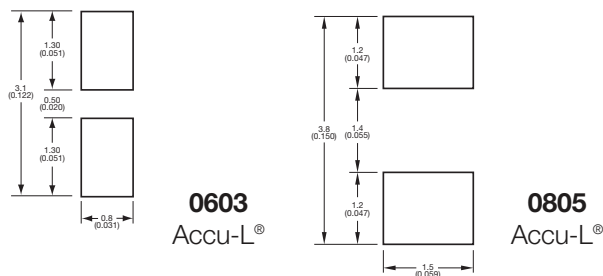

REFLOW SOLDERING

DIMENSIONS: millimeters (inches)

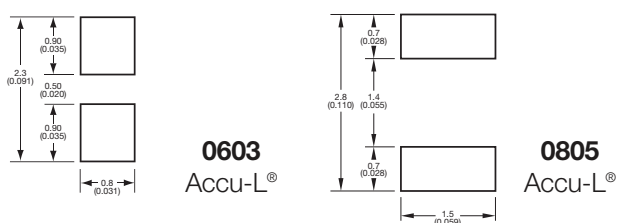

PREHEAT & SOLDERING

The rate of preheat in production should not exceed 4°C/second. It is recommended not to exceed 2°C/second.

Temperature differential from preheat to soldering should not exceed 150°C.

For further specific application or process advice, please consult AVX.

HAND SOLDERING & REWORK

Hand soldering is permissible. Preheat of the PCB to 100°C is required. The most preferable technique is to use hot air soldering tools. Where a soldering iron is used, a temperature controlled model not exceeding 30 watts should be used and set to not more than 260°C. Maximum allowed time at temperature is 1 minute. When hand soldering, the base side (white side) must be soldered to the board.

COOLING

After soldering, the assembly should preferably be allowed to cool naturally. In the event of assisted cooling, similar conditions to those recommended for preheating should be used.

CLEANING RECOMMENDATIONS

Care should be taken to ensure that the devices are thoroughly cleaned of flux residues, especially the space beneath the device. Such residues may otherwise become conductive and effectively offer a lossy bypass to the device. Various recommended cleaning conditions (which must be optimized for the flux system being used) are as follows:

Cleaning liquids i-propanol, ethanol, acetylacetone, water, and other standard PCB cleaning liquids.

Ultrasonic conditions . . . power – 20w/liter max.
frequency – 20kHz to 45kHz.

Temperature 80°C maximum (if not otherwise limited by chosen solvent system).

Time 5 minutes max.

STORAGE CONDITIONS

Recommended storage conditions for Accu-L[®] prior to use are as follows:

Temperature 15°C to 35°C

Humidity ≤65%

Air Pressure 860mbar to 1060mbar

RECOMMENDED SOLDERING PROFILE

For recommended soldering profile see page 23



Thin-Film Technology

CP0402/CP0603/CP0805
and DB0603N/DB0805 3dB 90°
Thin-Film RF/Microwave
Directional Couplers

3

Thin Film Directional Coupler



CP0402P High Directivity, Tight Coupling Tolerance

GENERAL DESCRIPTION

ITF (Integrated Thin-Film) TECHNOLOGY

The CP0402P Series High Directivity, Tight Coupling Tolerance LGA Coupler is based on the proprietary RFAP Thin-Film multilayer technology. The technology provides a miniature part with excellent high frequency performance and rugged construction for reliable automatic assembly.

The ITF Coupler is offered in a variety of frequency bands compatible with various types of high frequency wireless systems.

APPLICATIONS

- Wireless communications
- Wireless LAN's
- GPS
- WiMAX

LAND GRID ARRAY ADVANTAGES

- Inherent Low Profile
- Self Alignment during Reflow
- Excellent Solderability
- Low Parasitics
- Better Heat Dissipation

DIMENSIONS: (Bottom View)

millimeters (inches)

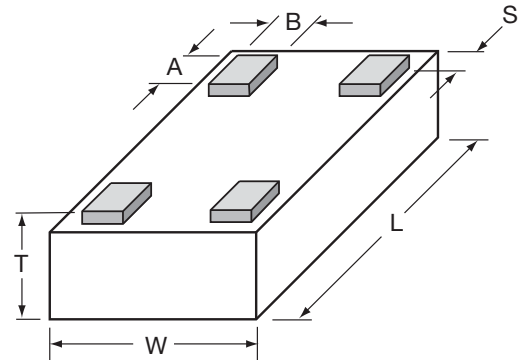

L	1.00±0.05 (0.040±0.002)	A	0.20±0.05 (0.008±0.002)
W	0.58±0.04 (0.023±0.002)	B	0.18±0.05 (0.007±0.002)
T	0.35±0.05 (0.014±0.002)	S	0.05±0.05 (0.002±0.002)

3

HOW TO ORDER

CP
T
Style

0402
T
Size
0402

P
T
Type
±0.5dB
Tight Tolerance

XXXX
T
Frequency
MHz

X
T
Sub-Type

N
T
Termination
LGA
Lead-Free

TR
T
Taped & Reeled

QUALITY INSPECTION

Finished parts are 100% tested for electrical parameters and visual characteristics. Each production lot is evaluated on a sample basis for:

- Static Humidity: 85°C, 85% RH, 160 hours
- Endurance: 125°C, I_b, 4 hours

TERMINATION

Nickel/Lead-Free Solder coating compatible with automatic soldering technologies: reflow, wave soldering, vapor phase and manual.

TERMINALS (Top View)

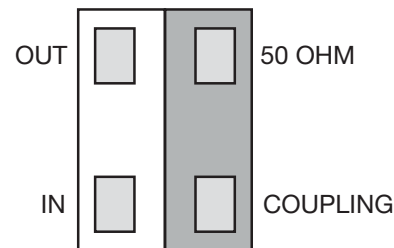

OPERATING TEMPERATURE:

-40°C to +85°C

Recommended Pad Layout Dimensions

mm (inches)

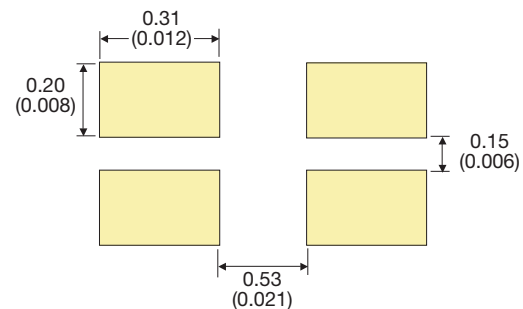

Thin Film Directional Coupler



CP0402P High Directivity, Tight Coupling Tolerance

Coupler P/N CP0402PxxxxANTR

Application	P/N Examples	Frequency Band [MHz]	Coupling [dB]	I. Loss max. [dB]	Return Loss [dB]	Directivity [dB]
AMPS	CP0402P0836AN	824 - 849	19.10±0.5	0.25	32	21
	CP0402P0881AN	869 - 894	18.60±0.5	0.25	31	
GSM	CP0402P0902AN	890 - 915	18.50±0.5	0.25	31	
	CP0402P0947AN	935 - 960	18.00±0.5	0.25	31	
E-GSM	CP0402P0897AN	880 - 915	18.50±0.5	0.25	31	
	CP0402P0942AN	925 - 960	18.00±0.5	0.25	31	
PDC	CP0402P1441AN	1429 - 1453	14.50±0.5	0.40	28	
PCN	CP0402P1747AN	1710 - 1785	13.00±0.5	0.50	26	
	CP0402P1842AN	1805 - 1880	12.50±0.5	0.50	26	
PCS	CP0402P1880AN	1850 - 1910	12.30±0.5	0.50	25	
	CP0402P1960AN	1930 - 1990	12.00±0.5	0.50	25	
PHP	CP0402P1907AN	1895 - 1920	12.30±0.5	0.50	25	
	CP0402P1950AN	1920 - 1980	12.00±0.5	0.50	25	
WCDMA	CP0402P2140AN	2110 - 2170	11.00±0.5	0.60	25	
	CP0402P1890AN	1880 - 1900	12.30±0.5	0.50	25	
Wireless LAN	CP0402P2442AN	2400 - 2484	10.30±0.5	0.70	23	
	CP0402P3500AN	3400 - 3600	7.50±0.5	1.30	20	
						19

CP0402PxxxxANTR

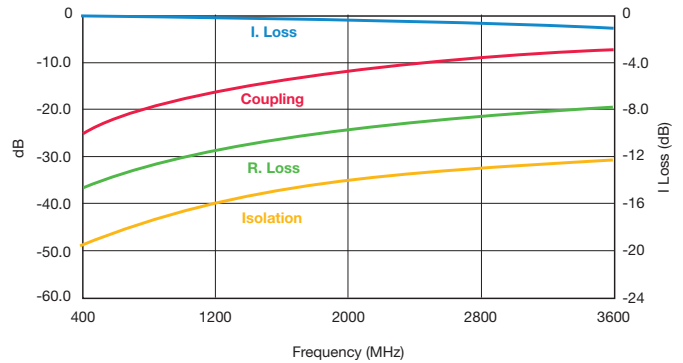

Coupler P/N CP0402PxxxxBNTR

Application	P/N Examples	Frequency Band [MHz]	Coupling [dB]	I. Loss max. [dB]	Return Loss [dB]	Directivity [dB]
AMPS	CP0402P0836BN	824 - 849	22.00±0.5	0.20	28	27
	CP0402P0881BN	869 - 894	21.70±0.5	0.20	28	
GSM	CP0402P0902BN	890 - 915	21.50±0.5	0.20	28	
	CP0402P0947BN	935 - 960	21.00±0.5	0.25	27	
E-GSM	CP0402P0897BN	880 - 915	21.50±0.5	0.20	28	
	CP0402P0942BN	925 - 960	21.00±0.5	0.25	27	
PDC	CP0402P1441BN	1429 - 1453	17.50±0.5	0.25	24	
	CP0402P1747BN	1710 - 1785	16.00±0.5	0.30	23	
PCN	CP0402P1842BN	1805 - 1880	15.50±0.5	0.35	23	
	CP0402P1880BN	1850 - 1910	15.50±0.5	0.35	23	
PHP	CP0402P1960BN	1930 - 1990	15.00±0.5	0.35	22	
	CP0402P1907BN	1895 - 1920	15.50±0.5	0.35	23	
WCDMA	CP0402P1950BN	1920 - 1980	15.00±0.5	0.35	23	
	CP0402P2140BN	2110 - 2170	14.00±0.5	0.40	23	
DECT	CP0402P1890BN	1880 - 1900	15.50±0.5	0.35	23	
Wireless LAN	CP0402P2442BN	2400 - 2484	13.30±0.5	0.40	21	
	CP0402P3500BN	3400 - 3600	9.50±0.5	0.80	17	

CP0402PxxxxBNTR

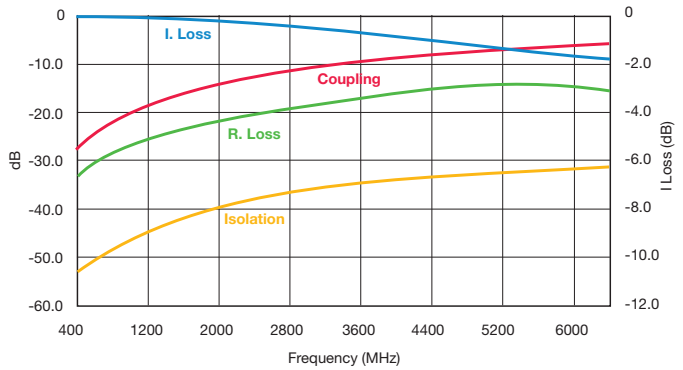

Coupler P/N CP0402PxxxxENTR

Application	P/N Examples	Frequency Band [MHz]	Coupling [dB]	I. Loss max. [dB]	Return Loss [dB]	Directivity [dB]
AMPS	CP0402P0836EN	824 - 849	27.20±0.5	0.20	35	25
	CP0402P0881EN	869 - 894	26.80±0.5	0.20	34	
GSM	CP0402P0902EN	890 - 915	26.50±0.5	0.20	34	
	CP0402P0947EN	935 - 960	26.00±0.5	0.20	34	
E-GSM	CP0402P0897EN	880 - 915	26.50±0.5	0.20	34	
	CP0402P0942EN	925 - 960	26.00±0.5	0.20	34	
PDC	CP0402P1441EN	1429 - 1453	22.30±0.5	0.25	29	
PCN	CP0402P1747EN	1710 - 1785	20.50±0.5	0.25	27	
	CP0402P1842EN	1805 - 1880	20.30±0.5	0.25	26	
PCS	CP0402P1880EN	1850 - 1910	20.00±0.5	0.25	26	
	CP0402P1960EN	1930 - 1990	20.00±0.5	0.25	26	
PHP	CP0402P1907EN	1895 - 1920	20.00±0.5	0.25	26	
	CP0402P1950EN	1920 - 1980	20.00±0.5	0.25	26	
WCDMA	CP0402P2140EN	2110 - 2170	18.80±0.5	0.30	26	
	CP0402P1890EN	1880 - 1900	20.00±0.5	0.25	26	
Wireless LAN	CP0402P2442EN	2400 - 2484	18.00±0.5	0.35	23	
	CP0402P3500EN	3400 - 3600	15.00±0.5	0.40	18	

CP0402PxxxxENTR

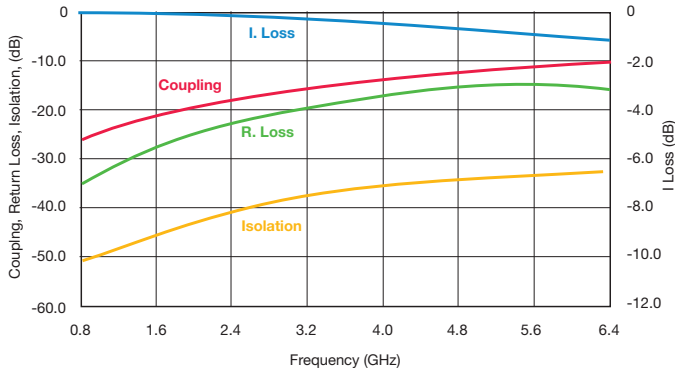

3

Thin-Film Directional Couplers



CP0402 High Directivity LGA Termination

GENERAL DESCRIPTION

ITF (Integrated Thin-Film) TECHNOLOGY

The ITF High Directivity LGA Coupler is based on thin-film multilayer technology. The technology provides a miniature part with excellent high frequency performance and rugged construction for reliable automatic assembly.

The ITF Coupler is offered in a variety of frequency bands compatible with various types of high frequency wireless systems.

APPLICATIONS

- Mobile Communications
- Satellite TV Receivers
- GPS
- Vehicle Location Systems
- Wireless LAN's

FEATURES

- Inherent Low Profile
- Self Alignment during Reflow
- Excellent Solderability
- Low Parasitics
- Better Heat Dissipation
- Operating/Storage Temp -40°C to +85°C
- Power Rating 3W RF Cont

DIMENSIONS: (Bottom View)

millimeters (inches)

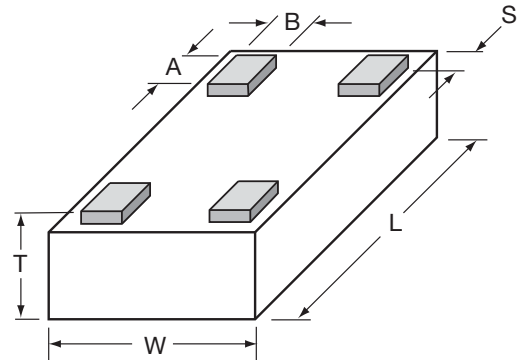

L	1.00±0.05 (0.040±0.002)
W	0.58±0.04 (0.023±0.002)
T	0.35±0.05 (0.014±0.002)

A	0.20±0.05 (0.008±0.002)
B	0.18±0.05 (0.007±0.002)
S	0.05±0.05 (0.002±0.002)

3

HOW TO ORDER

CP ┆ Style Directional Coupler	0402 ┆ Size 0402	X ┆ Type	**** ┆ Frequency (MHz)	X ┆ Sub Type	N ┆ LGA Termination L = LGA Sn90, Pb10 **N = LGA Sn100	TR ┆ Packaging Code TR = Tape and Reel
---	---	------------------------------	---	----------------------------------	--	---

**RoHS Compliant

QUALITY INSPECTION

Finished parts are 100% tested for electrical parameters and visual characteristics. Each production lot is evaluated on a sample basis for:

- Static Humidity: 85°C, 85% RH, 160 hours
- Endurance: 125°C, I_R, 4 hours

TERMINATION

Sn90Pb10 or Lead-Free Sn100 Nickel/Solder coating compatible with automatic soldering technologies: reflow, wave soldering, vapor phase and manual.

TERMINALS (Top View)

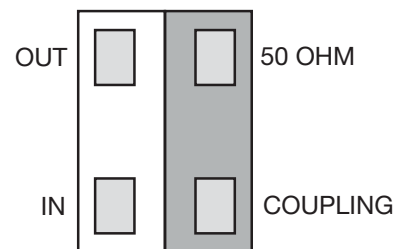

ORIENTATION IN TAPE

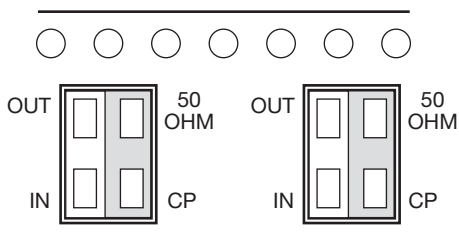

Recommended Pad Layout Dimensions

mm (inches)

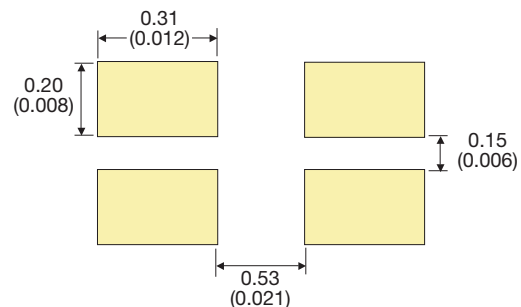

*The recommended distance to the PCB Ground Plane is 0.254mm (0.010")

COUPLER TYPE SELECTION GRAPH

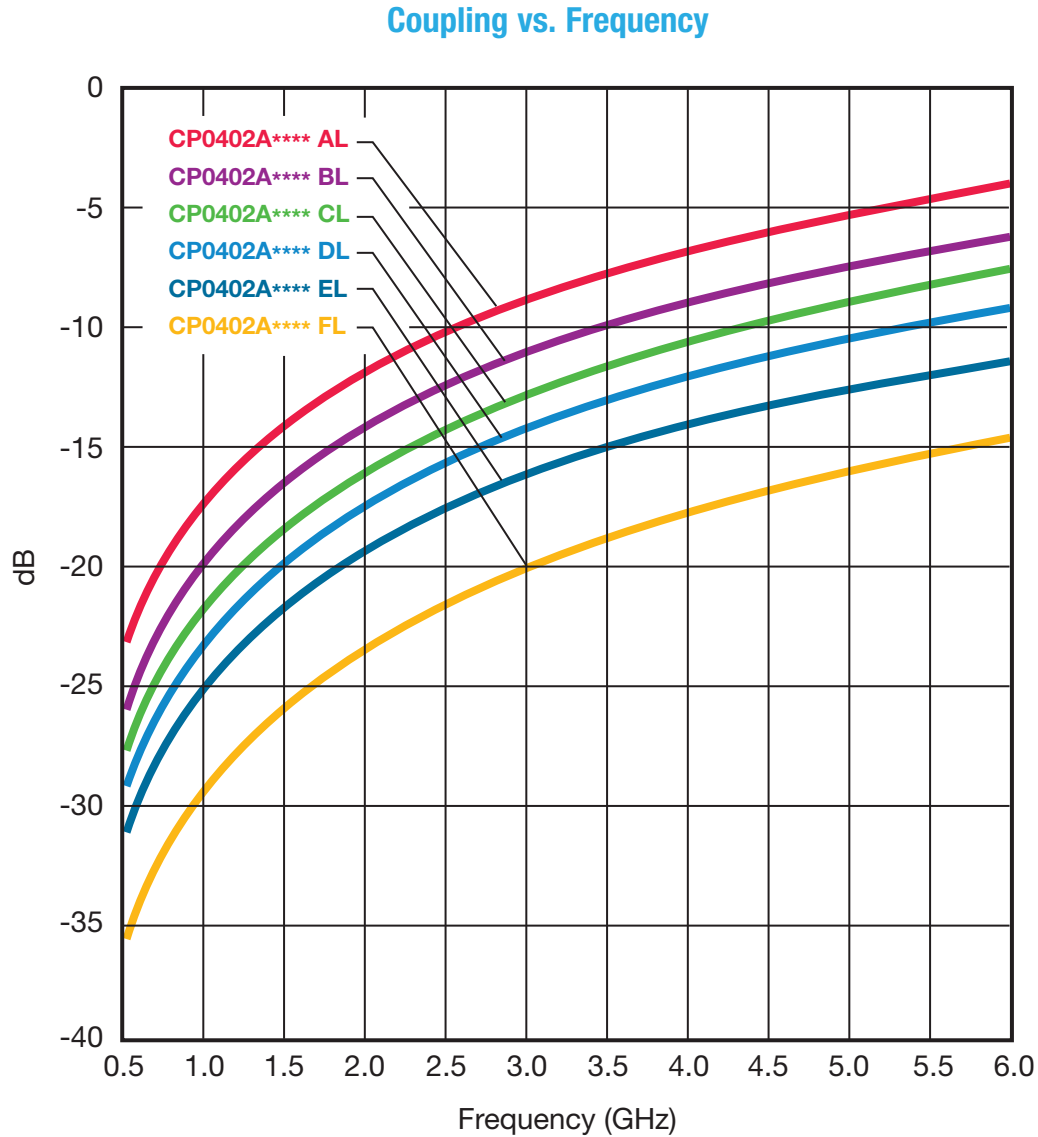

3

Intermediate coupling factors are readily available.
Please contact factory.

Thin-Film Directional Couplers



CP0402 High Directivity LGA Termination

Coupler P/N CP0402AxxxxAL

Application	P/N Examples	Frequency Band [MHz]	Coupling [dB]	I. Loss max. [dB]	Return Loss [dB]	Directivity [dB]
AMPS	CP0402A0836AL	824 - 849	19.10	0.25	32	21
	CP0402A0881AL	869 - 894	18.60			
GSM	CP0402A0902AL	890 - 915	18.50	0.25	31	
	CP0402A0947AL	935 - 960	18.00			
E-GSM	CP0402A0897AL	880 - 915	18.50	0.25	31	
	CP0402A0942AL	925 - 960	18.00			
PDC	CP0402A1441AL	1429 - 1453	14.50	0.40	28	
PCN	CP0402A1747AL	1710 - 1785	13.00	0.50	26	
	CP0402A1842AL	1805 - 1880	12.50			
PCS	CP0402A1880AL	1850 - 1910	12.30	0.50	25	
	CP0402A1960AL	1930 - 1990	12.00			
PHP	CP0402A1907AL	1895 - 1920	12.30	0.50	25	
DECT	CP0402A1890AL	1880 - 1900	12.30	0.70	23	
Wireless LAN	CP0402A2442AL	2400 - 2484	10.30	0.70	23	

CP0402AxxxxALTR

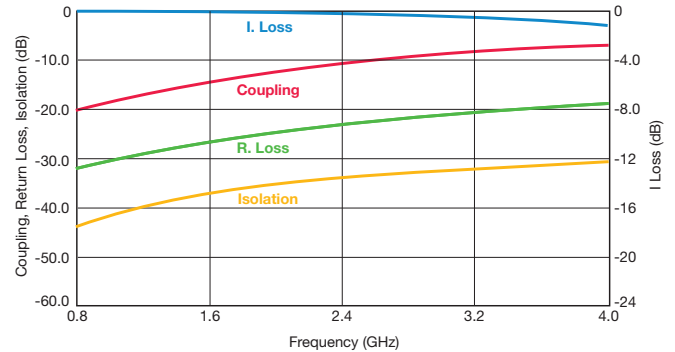

Coupler P/N CP0402AxxxxBL

Application	P/N Examples	Frequency Band [MHz]	Coupling [dB]	I. Loss max. [dB]	Return Loss [dB]	Directivity [dB]
AMPS	CP0402A0836BL	824 - 849	22.00	0.20	28	27
	CP0402A0881BL	869 - 894	21.70			
GSM	CP0402A0902BL	890 - 915	21.50	0.25	27	
	CP0402A0947BL	935 - 960	21.00			
E-GSM	CP0402A0897BL	880 - 915	21.50	0.20	28	
	CP0402A0942BL	925 - 960	21.00			
PDC	CP0402A1441BL	1429 - 1453	17.50	0.25	24	
PCN	CP0402A1747BL	1710 - 1785	16.00	0.30	23	
	CP0402A1842BL	1805 - 1880	15.50			
PCS	CP0402A1880BL	1850 - 1910	15.00	0.35	22	
	CP0402A1960BL	1930 - 1990	15.00			
PHP	CP0402A1907BL	1895 - 1920	15.50	0.35	23	
DECT	CP0402A1890BL	1880 - 1900	15.50	0.40	21	
Wireless LAN	CP0402A2442BL	2400 - 2484	13.30	0.40	21	

CP0402AxxxxBLTR

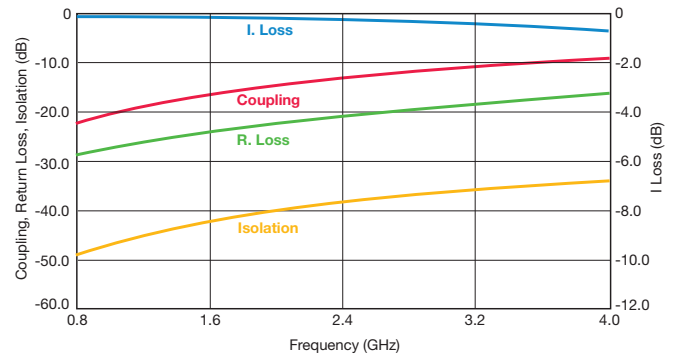

Coupler P/N CP0402AxxxxCL

Application	P/N Examples	Frequency Band [MHz]	Coupling [dB]	I. Loss max. [dB]	Return Loss [dB]	Directivity [dB]
AMPS	CP0402A0836CL	824 - 849	23.60	0.20	33	22
	CP0402A0881CL	869 - 894	23.00			
GSM	CP0402A0902CL	890 - 915	23.00	0.20	26	
	CP0402A0947CL	935 - 960	22.50			
E-GSM	CP0402A0897CL	880 - 915	23.00	0.25	25	
	CP0402A0942CL	925 - 960	22.50			
PDC	CP0402A1441CL	1429 - 1453	19.00	0.25	31	
PCN	CP0402A1747CL	1710 - 1785	17.20	0.25	30	
	CP0402A1842CL	1805 - 1880	17.00			
PCS	CP0402A1880CL	1850 - 1910	16.80	0.25	29	
	CP0402A1960CL	1930 - 1990	16.50			
PHP	CP0402A1907CL	1895 - 1920	16.80	0.25	29	
DECT	CP0402A1890CL	1880 - 1900	16.80	0.45	30	
Wireless LAN	CP0402A2442CL	2400 - 2484	14.70	0.45	28	

CP0402AxxxxCLTR

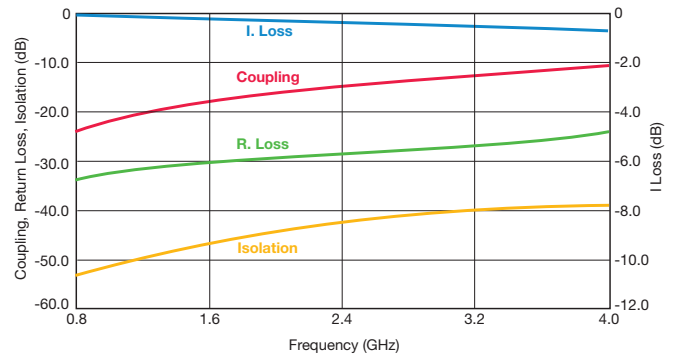

Important: Couplers can be used at any frequency within the indicated range.

Thin-Film Directional Couplers



CP0402 High Directivity LGA Termination

Coupler P/N CP0402AxxxxDL

Application	P/N Examples	Frequency Band [MHz]	Coupling [dB]	I. Loss max. [dB]	Return Loss [dB]	Directivity [dB]	
AMPS	CP0402A0836DL	824 - 849	25.20	0.20	29	20	
	CP0402A0881DL	869 - 894	24.80				
GSM	CP0402A0902DL	890 - 915	24.70				
	CP0402A0947DL	935 - 960	24.10				
E-GSM	CP0402A0897DL	880 - 915	24.70				
	CP0402A0942DL	925 - 960	24.10				
PDC	CP0402A1441DL	1429 - 1453	20.50		25		
PCN	CP0402A1747DL	1710 - 1785	19.00		24		
	CP0402A1842DL	1805 - 1880	18.50				
PCS	CP0402A1880DL	1850 - 1910	18.20		0.25		23
	CP0402A1960DL	1930 - 1990	18.00				
PHP	CP0402A1907DL	1895 - 1920	18.10				
DECT	CP0402A1890DL	1880 - 1900	18.20				
Wireless LAN	CP0402A2442DL	2400 - 2484	16.00	0.35		22	

CP0402AxxxxDLTR

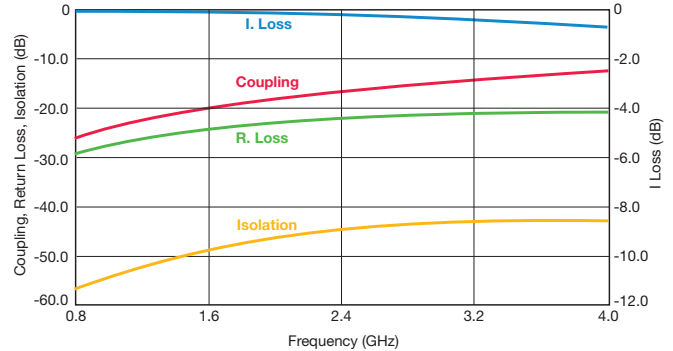

Coupler P/N CP0402AxxxxEL

Application	P/N Examples	Frequency Band [MHz]	Coupling [dB]	I. Loss max. [dB]	Return Loss [dB]	Directivity [dB]		
AMPS	CP0402A0836EL	824 - 849	27.20	0.20	35	25		
	CP0402A0881EL	869 - 894	26.80					
GSM	CP0402A0902EL	890 - 915	26.50					
	CP0402A0947EL	935 - 960	26.00					
E-GSM	CP0402A0897EL	880 - 915	26.50					
	CP0402A0942EL	925 - 960	26.00					
PDC	CP0402A1441EL	1429 - 1453	22.30		29			
PCN	CP0402A1747EL	1710 - 1785	20.50		27			
	CP0402A1842EL	1805 - 1880	20.30					
PCS	CP0402A1880EL	1850 - 1910	20.00		26		23	
	CP0402A1960EL	1930 - 1990						
PHP	CP0402A1907EL	1895 - 1920						
DECT	CP0402A1890EL	1880 - 1900						
Wireless LAN	CP0402A2442EL	2400 - 2484		18.00		0.35		23

CP0402AxxxxELTR

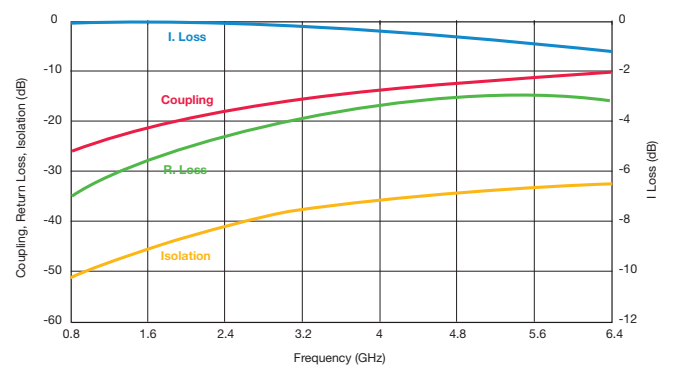

Coupler P/N CP0402AxxxxFL

Application	P/N Examples	Frequency Band [MHz]	Coupling [dB]	I. Loss max. [dB]	Return Loss [dB]	Directivity [dB]
AMPS	CP0402A0836FL	824 - 849	31.00	0.20	29.10	11
	CP0402A0881FL	869 - 894	30.70		28.60	
GSM	CP0402A0902FL	890 - 915	30.60		28.50	
	CP0402A0947FL	935 - 960	30.00		28.10	
E-GSM	CP0402A0897FL	880 - 915	30.60		28.50	
	CP0402A0942FL	925 - 960	30.00		28.10	
PDC	CP0402A1441FL	1429 - 1453	26.50		25.00	
PCN	CP0402A1747FL	1710 - 1785	25.00		23.80	
	CP0402A1842FL	1805 - 1880	24.50		23.60	
PCS	CP0402A1880FL	1850 - 1910	24.20		23.50	
	CP0402A1960FL	1930 - 1990	24.00	23.30		
PHP	CP0402A1907FL	1895 - 1920	24.20	23.40		
DECT	CP0402A1890FL	1880 - 1900	24.20	23.50		
Wireless LAN	CP0402A2442FL	2400 - 2484	22.00	0.25	22.60	

CP0402AxxxxFLTR

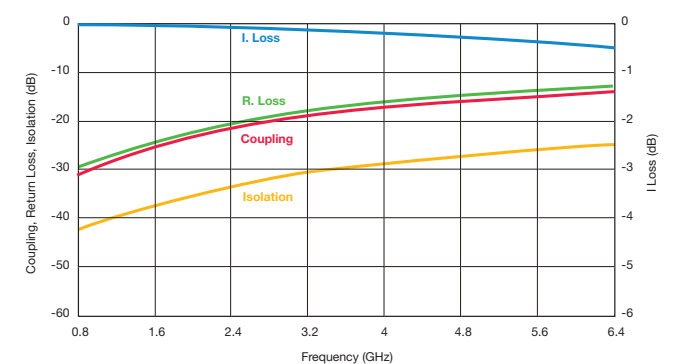

Important: Couplers can be used at any frequency within the indicated range.



Thin-Film Directional Couplers



CP0603 High Directivity LGA Termination

GENERAL DESCRIPTION ITF (Integrated Thin-Film) TECHNOLOGY

The ITF LGA Coupler is based on thin-film multilayer technology. The technology provides a miniature part with excellent high frequency performance and rugged construction for reliable automatic assembly. The ITF Coupler is offered in a variety of frequency bands compatible with various types of high frequency wireless systems.

APPLICATIONS

- Mobile Communications
- Satellite TV Receivers
- GPS
- Vehicle Location Systems
- Wireless LAN's

FEATURES

- Inherent Low Profile
- Self Alignment during Reflow
- Excellent Solderability
- Low Parasitics
- Better Heat Dissipation
- Operating/Storage Temp -40°C to +85°C
- Power Rating 3W RF Cont

DIMENSIONS: (Bottom View)

millimeters (inches)

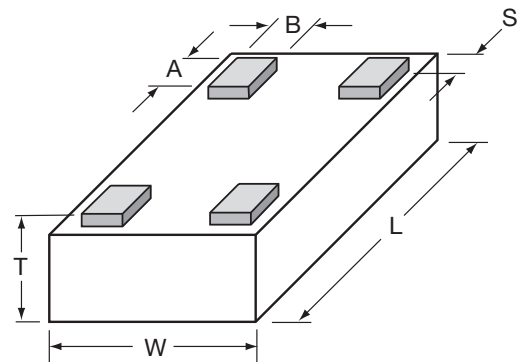

L	1.60±0.10 (0.063±0.004)	A	0.25±0.05 (0.010±0.002)
W	0.84±0.10 (0.033±0.004)	B	0.20±0.05 (0.008±0.002)
T	0.60±0.10 (0.024±0.004)	S	0.05±0.05 (0.002±0.002)

3

HOW TO ORDER

CP T	0603 T	X T	**** T	X T	N T	TR T
Style	Size	Type	Frequency (MHz)	Sub Type	Termination Code	Packaging Code
Directional Coupler	0603				L = LGA Sn90, Pb10 **N = LGA Sn100	TR = Tape and Reel
					**RoHS Compliant	

QUALITY INSPECTION

Finished parts are 100% tested for electrical parameters and visual characteristics. Each production lot is evaluated on a sample basis for:

- Static Humidity: 85°C, 85% RH, 160 hours
- Endurance: 125°C, I_R, 4 hours

TERMINATION

Sn90Pb10 or Lead-Free Sn100 Nickel/Solder coating compatible with automatic soldering technologies: reflow, wave soldering, vapor phase and manual.

TERMINALS (Top View)

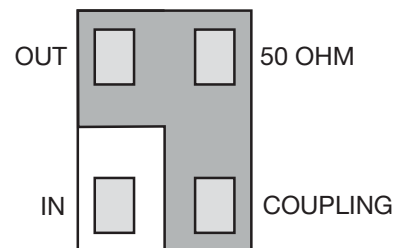

ORIENTATION IN TAPE

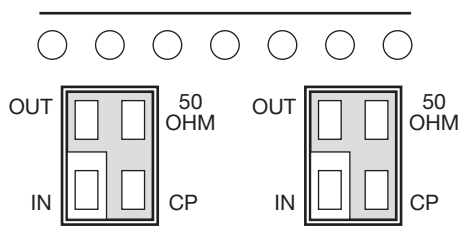

Recommended Pad Layout Dimensions

mm (inches)

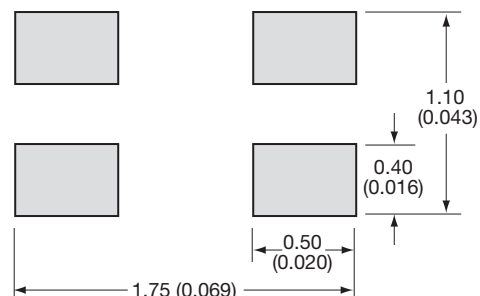

*The recommended distance to the PCB Ground Plane is 0.254mm (0.010")

Thin-Film Directional Couplers



CP0603 High Directivity LGA Termination

COUPLER TYPE SELECTION GRAPH

Coupling vs. Frequency

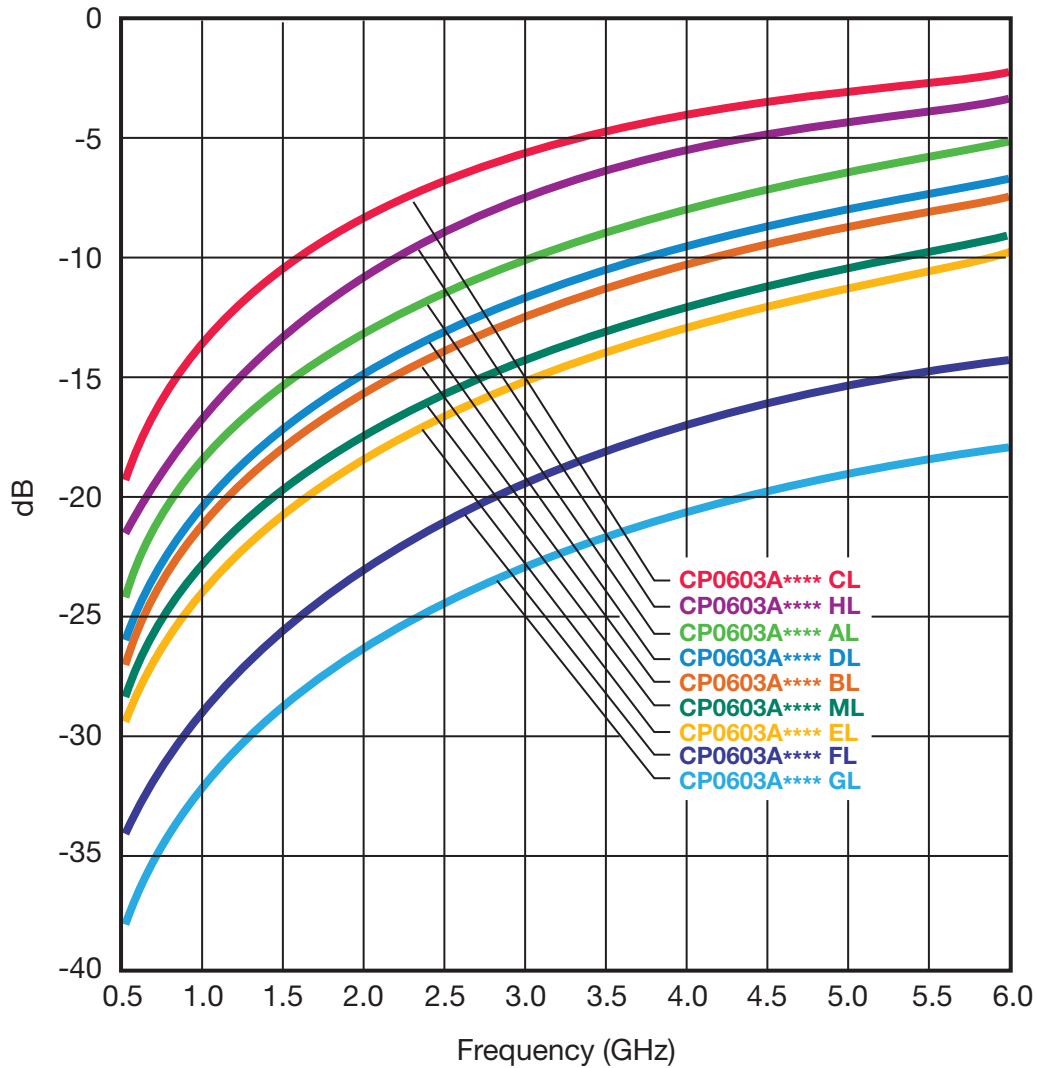

3

Intermediate coupling factors are readily available.
Please contact factory.



Thin-Film Directional Couplers



CP0603 High Directivity LGA Type

Coupler P/N CP0603AxxxxAL

Application	P/N Examples	Frequency Band [MHz]	Coupling [dB]	I. Loss max. [dB]	Return Loss [dB]	Directivity [dB]	
AMPS	CP0603A0836AL	824 - 849	20.0	0.25	28	22	
	CP0603A0881AL	869 - 894	19.7				
GSM	CP0603A0902AL	890 - 915	19.4				
	CP0603A0947AL	935 - 960	19.0				
E-GSM	CP0603A0897AL	880 - 915	19.4				
	CP0603A0942AL	925 - 960	19.0				
PDC	CP0603A1441AL	1429 - 1453	15.5		0.40		24
PCN	CP0603A1747AL	1710 - 1785	14.0		0.50		22
	CP0603A1842AL	1805 - 1880	13.5				
PCS	CP0603A1880AL	1850 - 1910	13.2		0.55		21
	CP0603A1960AL	1930 - 1990	13.0				
PHP	CP0603A1907AL	1895 - 1920	13.2	0.50	22		
DECT	CP0603A1890AL	1880 - 1900	13.2	0.50	22		
Wireless LAN	CP0603A2442AL	2400 - 2484	11.5	0.75	20		

CP0603AxxxxALTR

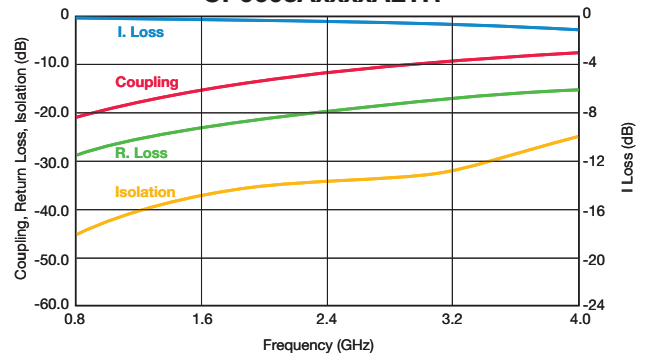

Coupler P/N CP0603AxxxxBL

Application	P/N Examples	Frequency Band [MHz]	Coupling [dB]	I. Loss max. [dB]	Return Loss [dB]	Directivity [dB]	
AMPS	CP0603A0836BL	824 - 849	23.0	0.20	31	20	
	CP0603A0881BL	869 - 894	22.7				
GSM	CP0603A0902BL	890 - 915	22.5				
	CP0603A0947BL	935 - 960	22.0				
E-GSM	CP0603A0897BL	880 - 915	22.5				
	CP0603A0942BL	925 - 960	22.0				
PDC	CP0603A1441BL	1429 - 1453	18.5		0.25		27
PCN	CP0603A1747BL	1710 - 1785	17.0				
	CP0603A1842BL	1805 - 1880	16.4		0.25		25
PCS	CP0603A1880BL	1850 - 1910	16.2				
	CP0603A1960BL	1930 - 1990	16.0	0.35	23		
PHP	CP0603A1907BL	1895 - 1920	16.1				
DECT	CP0603A1890BL	1880 - 1900	16.2	0.35	23		
Wireless LAN	CP0603A2442BL	2400 - 2484	14.2	0.35	23		

CP0603AxxxxBLTR

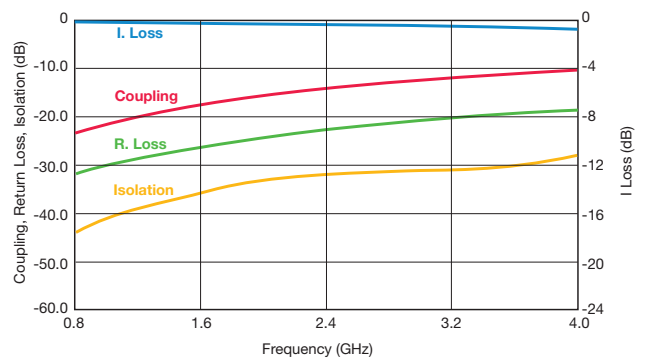

Coupler P/N CP0603AxxxxCL

Application	P/N Examples	Frequency Band [MHz]	Coupling [dB]	I. Loss max. [dB]	Return Loss [dB]	Directivity [dB]	
AMPS	CP0603A0836CL	824 - 849	15.2	0.35	23	23	
	CP0603A0881CL	869 - 894	15.0				
GSM	CP0603A0902CL	890 - 915	14.7				
	CP0603A0947CL	935 - 960	14.3				
E-GSM	CP0603A0897CL	880 - 915	14.7				
	CP0603A0942CL	925 - 960	14.3				
PDC	CP0603A1441CL	1429 - 1453	11.0		0.70		19
PCN	CP0603A1747CL	1710 - 1785	9.5		0.80		18
	CP0603A1842CL	1805 - 1880	9.0				
PCS	CP0603A1880CL	1850 - 1910	8.8		0.90		17
	CP0603A1960CL	1930 - 1990	8.5				
PHP	CP0603A1907CL	1895 - 1920	8.8	0.90	17		
DECT	CP0603A1890CL	1880 - 1900	8.8	0.90	17		
Wireless LAN	CP0603A2442CL	2400 - 2484	7.0	1.40	15		

CP0603AxxxxCLTR

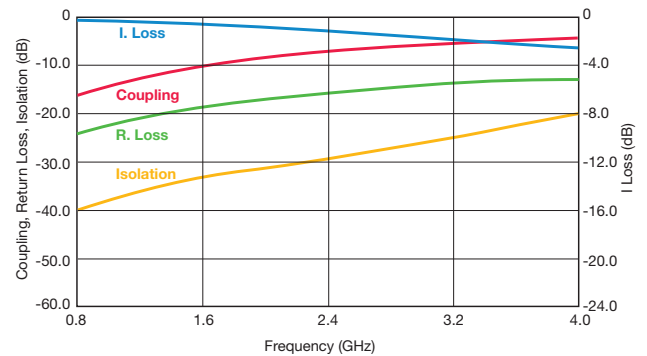

Important: Couplers can be used at any frequency within the indicated range.

Thin-Film Directional Couplers



CP0603 High Directivity LGA Type

Coupler P/N CP0603AxxxxDL

Application	P/N Examples	Frequency Band [MHz]	Coupling [dB]	I. Loss max. [dB]	Return Loss [dB]	Directivity [dB]
AMPS	CP0603A0836DL	824 - 849	22.0	0.25	31	22
	CP0603A0881DL	869 - 894	21.8			
GSM	CP0603A0902DL	890 - 915	21.3	0.30	30	
	CP0603A0947DL	935 - 960	21.0			
E-GSM	CP0603A0897DL	880 - 915	21.3	0.30	27	
	CP0603A0942DL	925 - 960	21.0			
PDC	CP0603A1441DL	1429 - 1453	17.7	0.40	25	
PCN	CP0603A1747DL	1710 - 1785	16.0		25	
	CP0603A1842DL	1805 - 1880	15.4			
PCS	CP0603A1880DL	1850 - 1910	15.2		24	21
	CP0603A1960DL	1930 - 1990	15.0			
PHP	CP0603A1907DL	1895 - 1920	15.2	22		
DECT	CP0603A1890DL	1880 - 1900	15.2			
Wireless LAN	CP0603A2442DL	2400 - 2484	13.3	0.55	22	

CP0603AxxxxDLTR

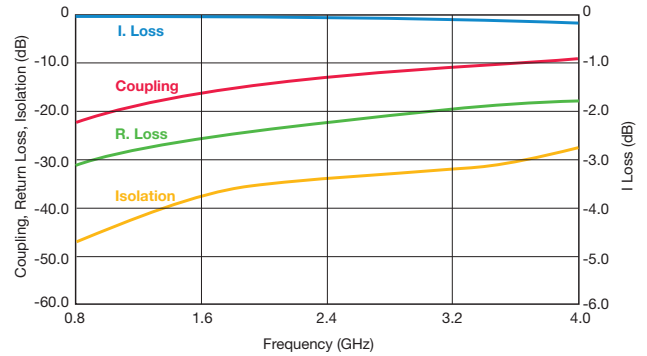

Coupler P/N CP0603AxxxxEL

Application	P/N Examples	Frequency Band [MHz]	Coupling [dB]	I. Loss max. [dB]	Return Loss [dB]	Directivity [dB]
AMPS	CP0603A0836EL	824 - 849	25.8	0.20	32	21
	CP0603A0881EL	869 - 894	25.3			
GSM	CP0603A0902EL	890 - 915	25.0	0.25	31	
	CP0603A0947EL	935 - 960	24.7			
E-GSM	CP0603A0897EL	880 - 915	25.0	0.30	32	
	CP0603A0942EL	925 - 960	24.7			
PDC	CP0603A1441EL	1429 - 1453	21.0	0.40	28	
PCN	CP0603A1747EL	1710 - 1785	19.5		26	
	CP0603A1842EL	1805 - 1880	19.0			
PCS	CP0603A1880EL	1850 - 1910	18.8		24	24
	CP0603A1960EL	1930 - 1990	18.5			
PHP	CP0603A1907EL	1895 - 1920	18.7	24		
DECT	CP0603A1890EL	1880 - 1900	18.8			
Wireless LAN	CP0603A2442EL	2400 - 2484	17.0	0.40	24	

CP0603AxxxxELTR

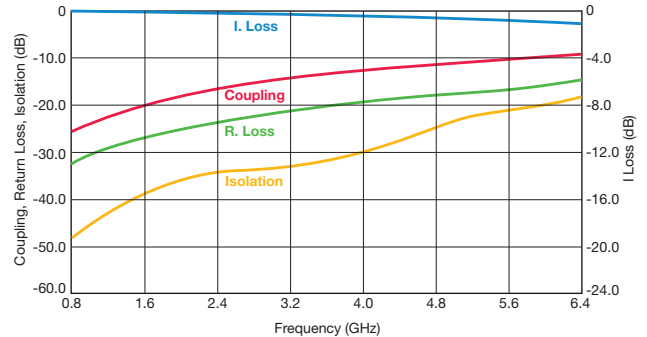

Coupler P/N CP0603AxxxxFL

Application	P/N Examples	Frequency Band [MHz]	Coupling [dB]	I. Loss max. [dB]	Return Loss [dB]	Directivity [dB]
AMPS	CP0603A0836FL	824 - 849	31.2	0.20	28	12
	CP0603A0881FL	869 - 894	30.8			
GSM	CP0603A0902FL	890 - 915	30.5	0.25	27	
	CP0603A0947FL	935 - 960	30.2			
E-GSM	CP0603A0897FL	880 - 915	30.5	0.30	23	
	CP0603A0942FL	925 - 960	30.2			
PDC	CP0603A1441FL	1429 - 1453	27.0	0.40	21	
PCN	CP0603A1747FL	1710 - 1785	25.0		21	
	CP0603A1842FL	1805 - 1880	24.5			
PCS	CP0603A1880FL	1850 - 1910	24.3		20	21
	CP0603A1960FL	1930 - 1990	24.0			
PHP	CP0603A1907FL	1895 - 1920	24.2	20		
DECT	CP0603A1890FL	1880 - 1900	24.2			
Wireless LAN	CP0603A2442FL	2400 - 2484	21.5	0.25	20	

CP0603AxxxxFLTR

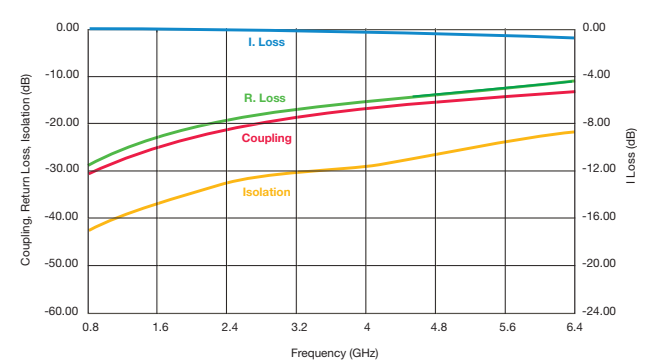

Important: Couplers can be used at any frequency within the indicated range.



Thin-Film Directional Couplers



CP0603 High Directivity LGA Type

Coupler P/N CP0603AxxxxGL

Application	P/N Examples	Frequency Band [MHz]	Coupling [dB]	I. Loss max. [dB]	Return Loss [dB]	Directivity [dB]
AMPS	CP0603A0836GL	824 - 849	34.2	0.20	39	13
	CP0603A0881GL	869 - 894	33.8			
GSM	CP0603A0902GL	890 - 915	33.6	0.20	38	
	CP0603A0947GL	935 - 960	33.2			
E-GSM	CP0603A0897GL	880 - 915	33.6	0.20	39	
	CP0603A0942GL	925 - 960	33.2			
PDC	CP0603A1441GL	1429 - 1453	30.0	0.25	34	
PCN	CP0603A1747GL	1710 - 1785	28.5			
	CP0603A1842GL	1805 - 1880	28.0			
PCS	CP0603A1880GL	1850 - 1910	27.7	0.25	31	
	CP0603A1960GL	1930 - 1990	27.5			
PHP	CP0603A1907GL	1895 - 1920	27.6	0.25	32	
DECT	CP0603A1890GL	1880 - 1900	27.7			
Wireless LAN	CP0603A2442GL	2400 - 2484	25.5	0.35	31	

CP0603AxxxxGLTR

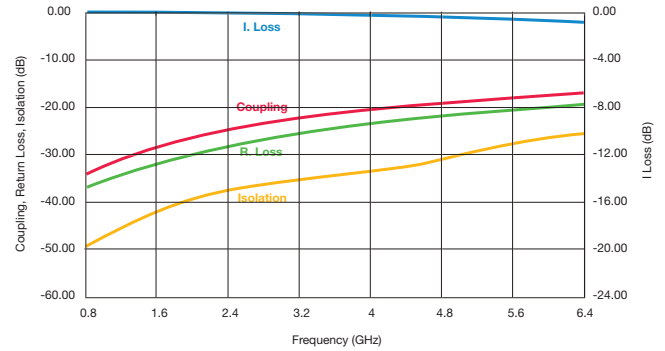

Coupler P/N CP0603AxxxxHL

Application	P/N Examples	Frequency Band [MHz]	Coupling [dB]	I. Loss max. [dB]	Return Loss [dB]	Directivity [dB]
AMPS	CP0603A0836HL	824 - 849	17.3	0.30	26	26
	CP0603A0881HL	869 - 894	17.0			
GSM	CP0603A0902HL	890 - 915	16.7	0.30	25	
	CP0603A0947HL	935 - 960	16.3			
E-GSM	CP0603A0897HL	880 - 915	17.0	0.35	25	
	CP0603A0942HL	925 - 960	16.3			
PDC	CP0603A1441HL	1429 - 1453	13.0	0.55	22	
PCN	CP0603A1747HL	1710 - 1785	11.4			
	CP0603A1842HL	1805 - 1880	11.0			
PCS	CP0603A1880HL	1850 - 1910	10.8	0.75	19	
	CP0603A1960HL	1930 - 1990	10.5			
PHP	CP0603A1907HL	1895 - 1920	10.7	0.75	19	
DECT	CP0603A1890HL	1880 - 1900	10.8			
Wireless LAN	CP0603A2442HL	2400 - 2484	8.8	1.00	17	

CP0603AxxxxHLTR

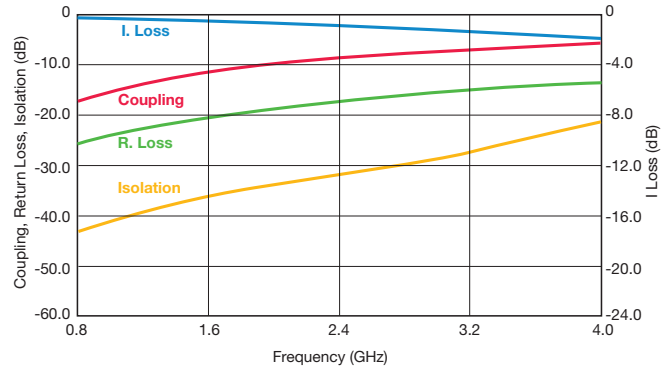

Coupler P/N CP0603AxxxxML

Application	P/N Examples	Frequency Band [MHz]	Coupling [dB]	I. Loss max. [dB]	Return Loss [dB]	Directivity [dB]
AMPS	CP0603A0836ML	824 - 849	24.2	0.20	33	23
	CP0603A0881ML	869 - 894	23.8			
GSM	CP0603A0902ML	890 - 915	23.4	0.20	32	
	CP0603A0947ML	935 - 960	23.2			
E-GSM	CP0603A0897ML	880 - 915	23.4	0.20	32	
	CP0603A0942ML	925 - 960	23.2			
PDC	CP0603A1441ML	1429 - 1453	20.0	0.25	28	
PCN	CP0603A1747ML	1710 - 1785	18.4			
	CP0603A1842ML	1805 - 1880	18.0			
PCS	CP0603A1880ML	1850 - 1910	17.8	0.25	26	
	CP0603A1960ML	1930 - 1990	17.5			
PHP	CP0603A1907ML	1895 - 1920	17.7	0.25	26	
DECT	CP0603A1890ML	1880 - 1900	17.8			
Wireless LAN	CP0603A2442ML	2400 - 2484	15.6	0.35	24	

CP0603AxxxxMLTR

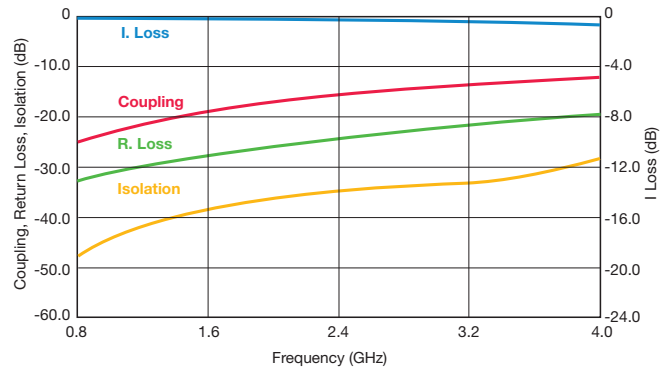

Important: Couplers can be used at any frequency within the indicated range.

Thin-Film Directional Couplers



CP0402 / CP0603 High Directivity Couplers Test Jigs

GENERAL DESCRIPTION

These jigs are designed for testing the CP0402 and CP0603 High Directivity Couplers using a Vector Network Analyzer.

They consist of a dielectric substrate, having 50Ω microstrips as conducting lines and a bottom ground plane located at a distance of 0.254mm (0.010") from the microstrips.

The substrate used is Neltec's NH9338ST0254C1BC.

The connectors are SMA type (female), 'Johnson Components Inc.' Product P/N: 142-0701-841.

Both a measurement jig and a calibration jig are provided.

The calibration jig is designed for a full 2-port calibration, and consists of an open line, short line and through line. LOAD calibration can be done by a 50Ω SMA termination.

MEASUREMENT PROCEDURE

When measuring a component, it can be either soldered or pressed using a non-metallic stick until all four ports touch the appropriate pads. Set the VNA to the relevant frequency band. Connect the VNA using a 10dB attenuator on the jig

terminal connected to port 2. Follow the VNA's instruction manual and use the [calibration jig](#) to perform a full 2-Port calibration in the required bandwidths.

3

Place the coupler on the [measurement jig](#) as follows:

Input (Coupler) → Connector 1 (Jig) Termination (Coupler) → Connector 3 (Jig)
Output (Coupler) → Connector 2 (Jig) Coupling (Coupler) → Connector 4 (Jig)

To measure I. Loss connect:

Connector 1 (Jig) → Port 1 (VNA) Connector 3 (Jig) → 50Ω
Connector 2 (Jig) → Port 2 (VNA) Connector 4 (Jig) → 50Ω

To measure R. Loss and Coupling connect:

Connector 1 (Jig) → Port 1 (VNA) Connector 3 (Jig) → 50Ω
Connector 2 (Jig) → 50Ω Connector 4 (Jig) → Port 2 (VNA)

To measure Isolation connect:

Connector 1 (Jig) → 50Ω Connector 3 (Jig) → 50Ω
Connector 2 (Jig) → Port 1 (VNA) Connector 4 (Jig) → Port 2 (VNA)

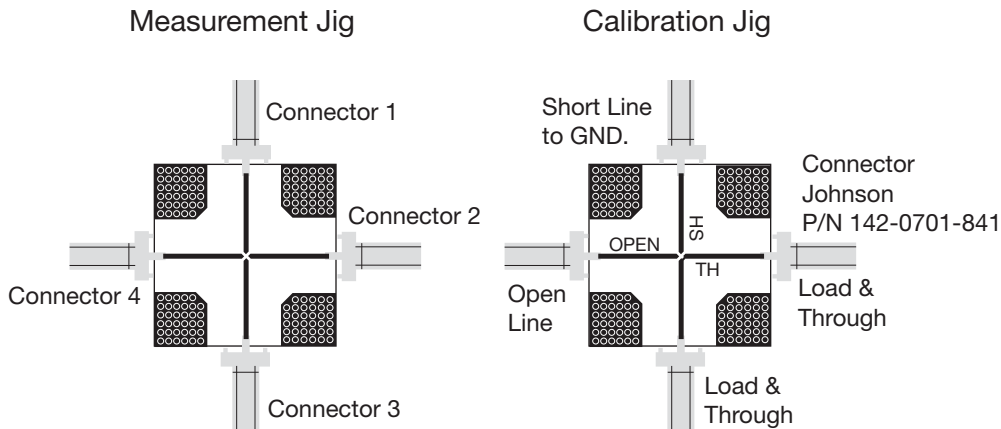

Thin-Film Directional Couplers



CP0603 SMD Type

GENERAL DESCRIPTION ITF (Integrated Thin-Film) TECHNOLOGY

The ITF SMD Coupler is based on thin-film multilayer technology. The technology provides a miniature part with excellent high frequency performance and rugged construction for reliable automatic assembly. The ITF Coupler is offered in a variety of frequency bands compatible with various types of high frequency wireless systems.

DIMENSIONS: millimeters (inches)

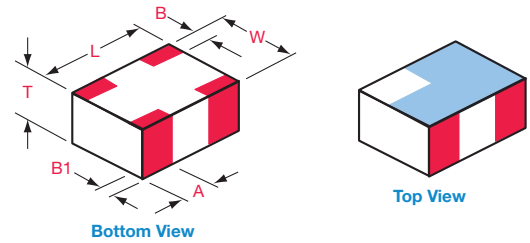

	0603
L	1.6±0.1 (0.063±0.004)
W	0.84±0.1 (0.033±0.004)
T	0.60±0.1 (0.028±0.004)
A	0.35±0.15 (0.014±0.006)
B	0.175±0.1 (0.007±0.004)
B1	0.00+0.1/0-0.0 (0.00+0.004/-0.0)

APPLICATIONS

- Mobile Communications
- Satellite TV Receivers
- GPS
- Vehicle Location Systems
- Wireless LAN's

FEATURES

- Miniature Size: 0603
- Frequency Range: 800MHz - 3GHz
- Characteristic Impedance: 50Ω
- Operating / Storage Temp.: -40°C to +85°C
- Power Rating: 3W Continuous
- Low Profile
- Rugged Construction
- Taped and Reeled

3

HOW TO ORDER

CP ↓ Style Directional Coupler	0603 ↓ Size 0603	X ↓ Type	**** ↓ Frequency MHz	X ↓ Sub Type	S ↓ Termination Code W = Sn90, Pb10 **S = Sn100 **RoHS Compliant	TR ↓ Packaging Code TR = Tape and Reel
---	---	------------------------------	---	----------------------------------	---	---

QUALITY INSPECTION

Finished parts are 100% tested for electrical parameters and visual characteristics. Each production lot is evaluated on a sample basis for:

- Static Humidity: 85°C, 85% RH, 160 hours
- Endurance: 125°C, I_R, 4 hours

TERMINATION

Nickel/Solder coating compatible with automatic soldering technologies: reflow, wave soldering, vapor phase and manual.

Recommended Pad Layout Dimensions mm (inches)

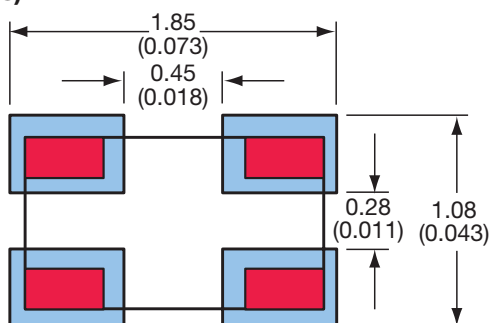

TERMINALS (Top View)

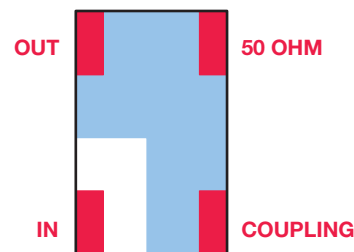

Please select correct termination style

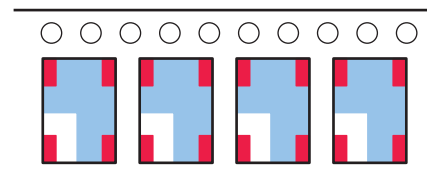

Orientation in tape

Thin-Film Directional Couplers



CP0603 SMD Type

Coupler P/N CP0603A****AW

Application	P/N Examples	Frequency Band [MHz]	Coupling [dB]	I. Loss max	VSWR max
AMPS	CP0603A0836AW	824 - 849	18.5±1	0.25	1.2
	CP0603A0881AW	869 - 894	18.5±1		
GSM	CP0603A0902AW	890 - 915	18±1	0.25	
	CP0603A0947AW	935 - 960	17.5±1		
E-GSM	CP0603A0897AW	880 - 915	18±1	0.4	
	CP0603A0942AW	925 - 960	17.5±1		
PDC	CP0603A1441AW	1429 - 1453	14±1	0.6	
PCN	CP0603A1747AW	1710 - 1785	12.5±1		
	CP0603A1842AW	1805 - 1880	12±1		
PCS	CP0603A1880AW	1850 - 1910	12±1	0.6	
	CP0603A1960AW	1930 - 1990	11.5±1		
PHP	CP0603A1907AW	1895 - 1920	12±1	0.85	
DECT	CP0603A1890AW	1880 - 1900	12±1		
Wireless LAN	CP0603A2442AW	2400 - 2484	10±1		

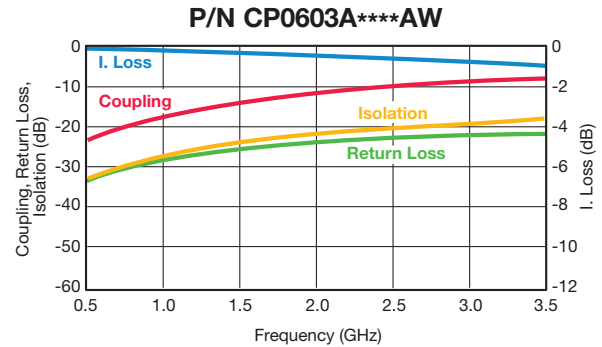

Coupler P/N CP0603A****BW

Application	P/N Examples	Frequency Band [MHz]	Coupling [dB]	I. Loss max	VSWR max
AMPS	CP0603A0836BW	824 - 849	16±1	0.25	1.2
	CP0603A0881BW	869 - 894	15.5±1		
GSM	CP0603A0902BW	890 - 915	15.5±1	0.55	
	CP0603A0947BW	935 - 960	15±1		
E-GSM	CP0603A0897BW	880 - 915	15.5±1	0.8	
	CP0603A0942BW	925 - 960	15±1		
PDC	CP0603A1441BW	1429 - 1453	11.5±1	1.3	
PCN	CP0603A1747BW	1710 - 1785	10±1		1.4
	CP0603A1842BW	1805 - 1880	9.5±1		
PCS	CP0603A1880BW	1850 - 1910	9±1	1.1	
	CP0603A1960BW	1930 - 1990	9±1		
PHP	CP0603A1907BW	1895 - 1920	9±1		
DECT	CP0603A1890BW	1880 - 1900	9±1		
Wireless LAN	CP0603A2442BW	2400 - 2484	7.5±1		

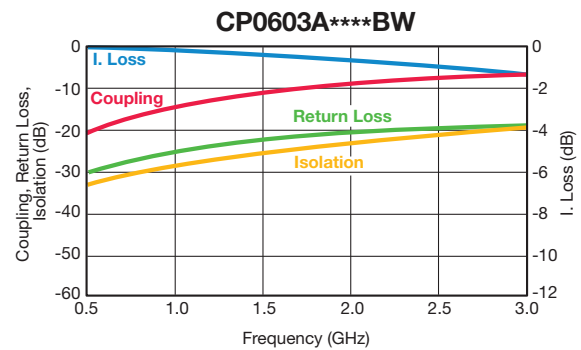

Coupler P/N CP0603A****CW

Application	P/N Examples	Frequency Band [MHz]	Coupling [dB]	I. Loss max	VSWR max
AMPS	CP0603A0836CW	824 - 849	21±1	0.25	1.2
	CP0603A0881CW	869 - 894	20.5±1		
GSM	CP0603A0902CW	890 - 915	20.5±1	0.40	
	CP0603A0947CW	935 - 960	20±1		
E-GSM	CP0603A0897CW	880 - 915	20.5±1	0.5	
	CP0603A0942CW	925 - 960	20±1		
PDC	CP0603A1441CW	1429 - 1453	16.5±1	0.65	
PCN	CP0603A1747CW	1710 - 1785	15±1		
	CP0603A1842CW	1805 - 1880	14.5±1		
PCS	CP0603A1880CW	1850 - 1910	14.5±1		
	CP0603A1960CW	1930 - 1990	14±1		
PHP	CP0603A1907CW	1895 - 1920	14.5±1		
DECT	CP0603A1890CW	1880 - 1900	14.5±1		
Wireless LAN	CP0603A2442CW	2400 - 2484	12.5±1		

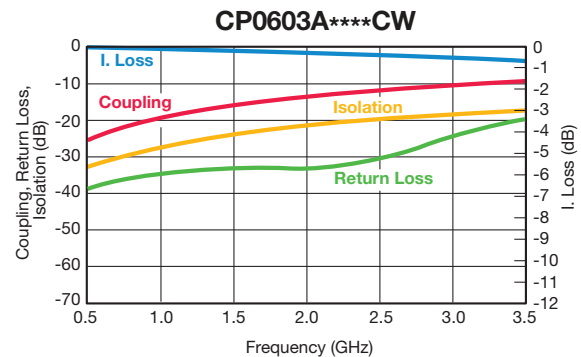

Coupler P/N CP0603A****DW

Application	P/N Examples	Frequency Band [MHz]	Coupling [dB]	I. Loss max	VSWR max
AMPS	CP0603A0836DW	824 - 849	15.0±1	0.40	1.2
	CP0603A0881DW	869 - 894	14.5±1		
GSM	CP0603A0902DW	890 - 915	14.5±1	0.7	
	CP0603A0947DW	935 - 960	14±1		
E-GSM	CP0603A0897DW	880 - 915	14.5±1	0.9	
	CP0603A0942DW	925 - 960	14±1		
PDC	CP0603A1441DW	1429 - 1453	10.5±1	1.0	
PCN	CP0603A1747DW	1710 - 1785	9±1		1.5
	CP0603A1842DW	1805 - 1880	8.5±1		
PCS	CP0603A1880DW	1850 - 1910	8.5±1		
	CP0603A1960DW	1930 - 1990	8±1		
PHP	CP0603A1907DW	1895 - 1920	8.5±1		
DECT	CP0603A1890DW	1880 - 1900	8.5±1		
Wireless LAN	CP0603A2442DW	2400 - 2484	6.5±1		

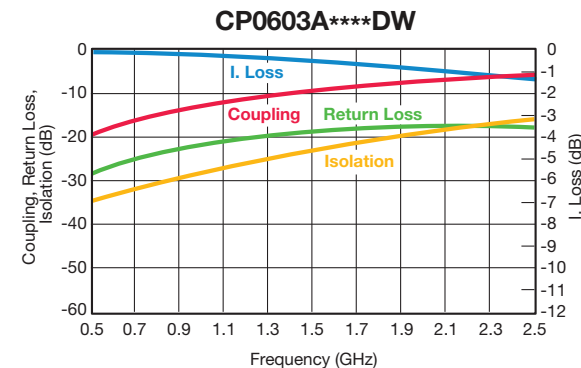

Important: Couplers can be used at any frequency within the indicated range.



Thin-Film Directional Couplers



CP0603 SMD Type

Coupler P/N CP0603B****AW

Application	P/N Examples	Frequency Band [MHz]	Coupling [dB]	I. Loss max	VSWR max	
AMPS	CP0603B0836AW	824 - 849	24.5±1	0.2	1.2	
	CP0603B0881AW	869 - 894	24±1			
GSM	CP0603B0902AW	890 - 915	24±1			
	CP0603B0947AW	935 - 960	23.5±1			
E-GSM	CP0603B0897AW	880 - 915	24±1			0.25
	CP0603B0942AW	925 - 960	23.5±1			
PDC	CP0603B1441AW	1429 - 1453	20±1	0.3		
PCN	CP0603B1747AW	1710 - 1785	18±1			
	PCS	CP0603B1842AW	1805 - 1880	17.5±1		0.45
CP0603B1880AW		1850 - 1910	17.5±1			
PHP	CP0603B1960AW	1930 - 1990	17.5±1	0.45		
	CP0603B1907AW	1895 - 1920	17.5±1			
DECT	CP0603B1890AW	1880 - 1900	17.5±1	0.45		
Wireless LAN	CP0603B2442AW	2400 - 2484	15.5±1			

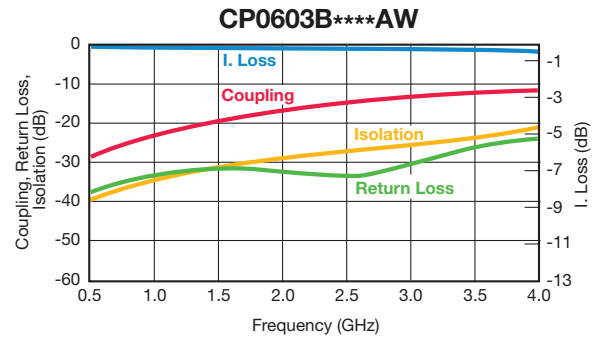

Coupler P/N CP0603B****BW

Application	P/N Examples	Frequency Band [MHz]	Coupling [dB]	I. Loss max	VSWR max	
AMPS	CP0603B0836BW	824 - 849	25.5±1	0.2	1.2	
	CP0603B0881BW	869 - 894	25±1			
GSM	CP0603B0902BW	890 - 915	25±1			
	CP0603B0947BW	935 - 960	24.5±1			
E-GSM	CP0603B0897BW	880 - 915	25±1			0.25
	CP0603B0942BW	925 - 960	24.5±1			
PDC	CP0603B1441BW	1429 - 1453	21±1	0.25		
PCN	CP0603B1747BW	1710 - 1785	19±1			
	PCS	CP0603B1842BW	1805 - 1880	19±1		0.35
CP0603B1880BW		1850 - 1910	18.5±1			
PHP	CP0603B1960BW	1930 - 1990	18.5±1	0.35		
	CP0603B1907BW	1895 - 1920	18.5±1			
DECT	CP0603B1890BW	1880 - 1900	18.5±1	0.35		
Wireless LAN	CP0603B2442BW	2400 - 2484	16.5±1			

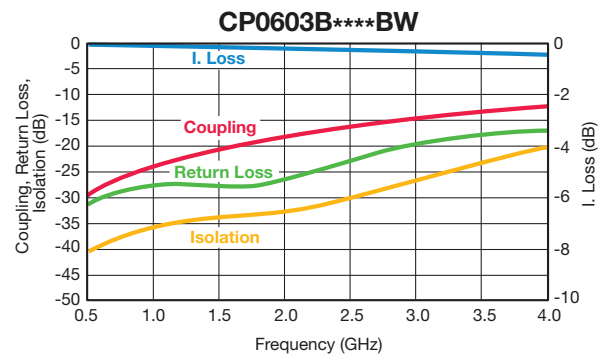

Coupler P/N CP0603B****CW

Application	P/N Examples	Frequency Band [MHz]	Coupling [dB]	I. Loss max	VSWR max	
AMPS	CP0603B0836CW	824 - 849	26.5±1	0.2	1.2	
	CP0603B0881CW	869 - 894	26±1			
GSM	CP0603B0902CW	890 - 915	26±1			
	CP0603B0947CW	935 - 960	25.5±1			
E-GSM	CP0603B0897CW	880 - 915	26±1			0.25
	CP0603B0942CW	925 - 960	25.5±1			
PDC	CP0603B1441CW	1429 - 1453	22±1	0.25		
PCN	CP0603B1747CW	1710 - 1785	20.5±1			
	PCS	CP0603B1842CW	1805 - 1880	20±1		0.35
CP0603B1880CW		1850 - 1910	20±1			
PHP	CP0603B1960CW	1930 - 1990	19.5±1	0.35		
	CP0603B1907CW	1895 - 1920	20±1			
DECT	CP0603B1890CW	1880 - 1900	20±1	0.35		
Wireless LAN	CP0603B2442CW	2400 - 2484	18±1			

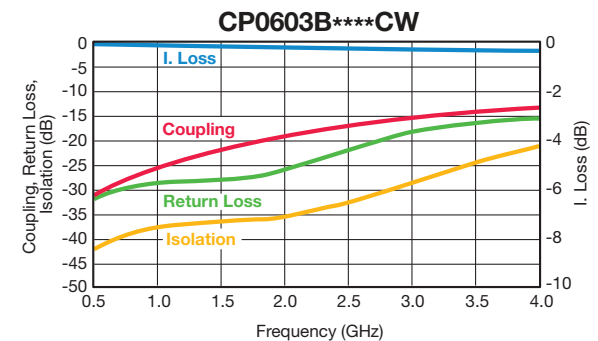

Important: Couplers can be used at any frequency within the indicated range.

Thin-Film Directional Couplers



CP0603 SMD Type – High Directivity

Coupler P/N CP0603D****AW

Application	P/N Examples	Frequency Band [MHz]	Coupling [dB]	I. Loss max. [dB]	Return Loss [dB]	Directivity [dB]
AMPS	CP0603D0836AW	824 - 849	13.50	0.50	23	21
	CP0603D0881AW	869 - 894	13.00			
GSM	CP0603D0902AW	890 - 915	12.50	1.40	16	17
	CP0603D0947AW	935 - 960	13.00			
E-GSM	CP0603D0897AW	880 - 915	12.50	2.00	15	15
	CP0603D0942AW	925 - 960	9.00			
PDC	CP0603D1441AW	1429 - 1453	8.00	7.50	17	18
PCN	CP0603D1747AW	1710 - 1785	7.00			
PCS	CP0603D1842AW	1805 - 1880	7.00	1.40	16	17
	CP0603D1880AW	1850 - 1910	7.00			
PHP	CP0603D1960AW	1930 - 1990	7.00	2.00	15	15
DECT	CP0603D1907AW	1895 - 1920	7.00			
Wireless LAN	CP0603D1890AW	1880 - 1900	5.50	2.00	15	15
	CP0603D2442AW	2400 - 2484	5.50			

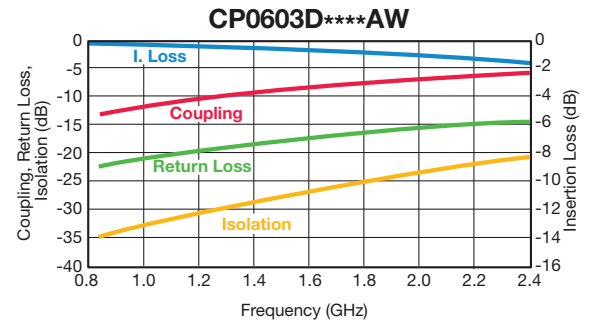

Coupler P/N CP0603D****BW

Application	P/N Examples	Frequency Band [MHz]	Coupling [dB]	I. Loss max. [dB]	Return Loss [dB]	Directivity [dB]
AMPS	CP0603D0836BW	824 - 849	20.00	0.25	36	19
	CP0603D0881BW	869 - 894	19.50			
GSM	CP0603D0902BW	890 - 915	19.00	0.55	27	19
	CP0603D0947BW	935 - 960	19.00			
E-GSM	CP0603D0897BW	880 - 915	19.00	0.70	24	19
	CP0603D0942BW	925 - 960	19.00			
PDC	CP0603D1441BW	1429 - 1453	15.50	11.00	24	19
PCN	CP0603D1747BW	1710 - 1785	14.00			
PCS	CP0603D1842BW	1805 - 1880	13.50	0.70	24	19
	CP0603D1880BW	1850 - 1910	13.00			
PHP	CP0603D1960BW	1930 - 1990	13.00	0.70	24	19
DECT	CP0603D1907BW	1895 - 1920	13.00			
Wireless LAN	CP0603D1890BW	1880 - 1900	11.00	0.70	24	19
	CP0603D2442BW	2400 - 2484	11.00			

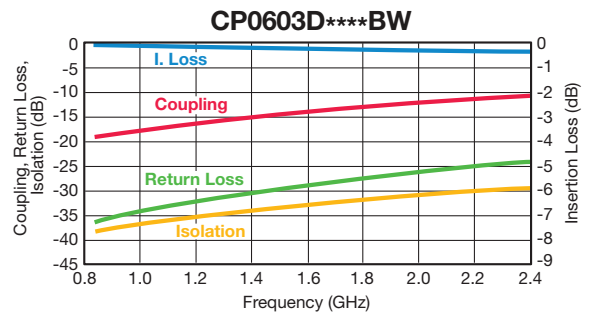

3

Important: Couplers can be used at any frequency within the indicated range.



Thin-Film Directional Couplers



CP0805 SMD Type

GENERAL DESCRIPTION ITF (Integrated Thin-Film) TECHNOLOGY

The ITF SMD Coupler is based on thin-film multilayer technology. The technology provides a miniature part with excellent high frequency performance and rugged construction for reliable automatic assembly. The ITF Coupler is offered in a variety of frequency bands compatible with various types of high frequency wireless systems.

FEATURES

- Small Size: 0805
- Frequency Range: 800MHz - 3GHz
- Characteristic Impedance: 50Ω
- Operating / Storage Temp.: -40°C to +85°C
- Power Rating: 3W Continuous
- Low Profile
- Rugged Construction
- Taped and Reeled

APPLICATIONS

- Mobile Communications
- Satellite TV Receivers
- GPS
- Vehicle Location Systems
- Wireless LAN's

DIMENSIONS: (Top View)

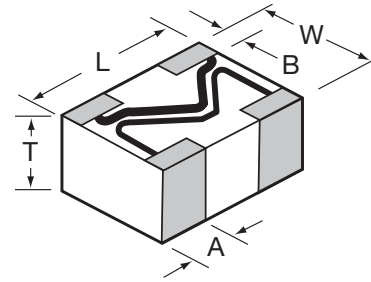

	0805
L	2.03±0.1 (0.080±0.004)
W	1.55±0.1 (0.061±0.004)
T	0.98±0.1 (0.039±0.004)
A	0.56±0.25 (0.022±0.010)
B	0.35±0.15 (0.014±0.006)

3

HOW TO ORDER

CP Style Directional Coupler	0805 Size 0805	A Layout Type (see layout types)	0902 Frequency MHz	A Sub Type (see layout sub-types)	S Termination Code W = Nickel/Solder (Sn/Pb) **S = Nickel / Lead Free Solder (Sn100)	TR Packaging Code TR = Tape and Reel
--	--	--	--	---	---	--

**RoHS Compliant

RoHS COMPLIANT

Pb: Free

Please select correct termination style

QUALITY INSPECTION

Finished parts are 100% tested for electrical parameters and visual characteristics. Each production lot is evaluated on a sample basis for:

- Static Humidity: 85°C, 85% RH, 160 hours
- Endurance: 125°C, I_R, 4 hours

TERMINATION

Nickel/Solder coating (Sn, Pb) compatible with automatic soldering technologies: reflow, wave soldering, vapor phase and manual.

Recommended Pad Layout Dimensions mm (inches)

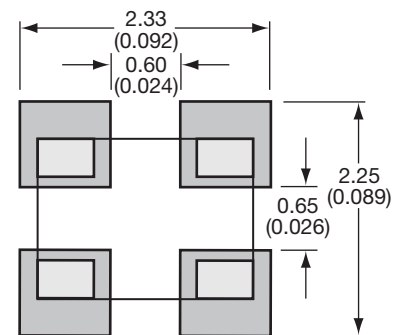

NOTE: Components must be mounted on the board with the white (Alumina) side DOWN.

Thin-Film Directional Couplers



CP0805 Layout Types

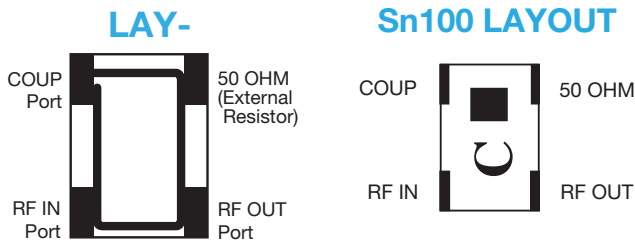

Type: A
Sub-Type: A

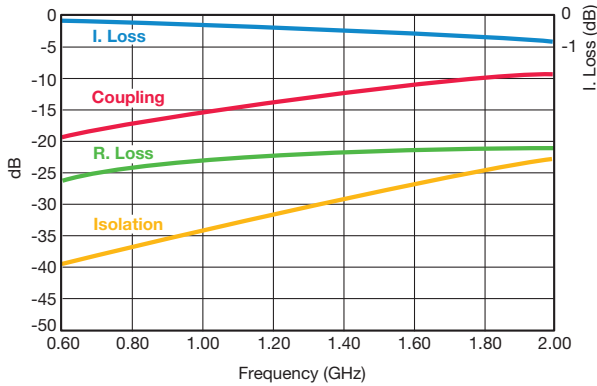

Application	P/N Examples	Frequency Band [MHz]	Coupling [dB]	I. Loss max	VSWR max
AMPS	CP0805A0836AW	824 - 849	16.5±1	0.25	1.2
	CP0805A0881AW	869 - 894	16±1		
GSM	CP0805A0902AW	890 - 915	16±1		
	CP0805A0947AW	935 - 960	15.5±1		
E-GSM	CP0805A0897AW	880 - 915	16±1		
	CP0805A0942AW	925 - 960	15.5±1		
PDC	CP0805A1441AW	1429 - 1453	12±1	0.5	1.3
PCN	CP0805A1747AW	1710 - 1785	10.5±1	0.7	1.4
	CP0805A1842AW	1805 - 1880	10±1	0.8	
PCS	CP0805A1880AW	1850 - 1910	9.5±1		
	CP0805A1960AW	1930 - 1990	9.5±1		
PHP	CP0805A1907AW	1895 - 1920	9.5±1		
DECT	CP0805A1890AW	1880 - 1900	9.5±1		

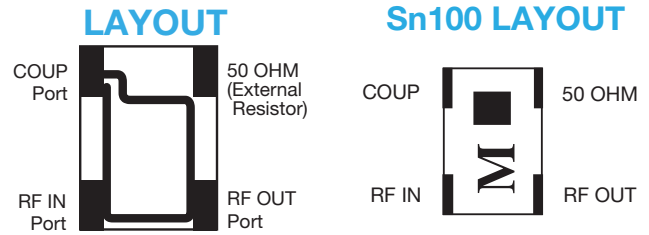

Type: A
Sub-Type: B

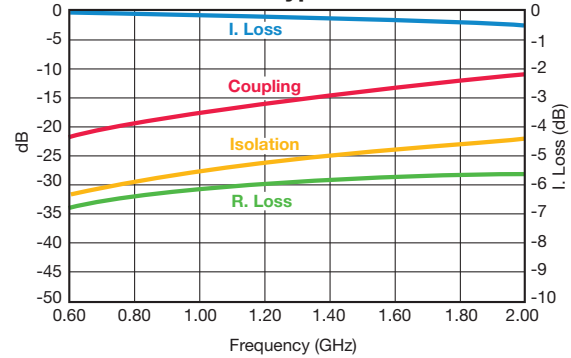

Application	P/N Examples	Frequency Band [MHz]	Coupling [dB]	I. Loss max	VSWR max
AMPS	CP0805A0836BW	824 - 849	19±1	0.25	1.2
	CP0805A0881BW	869 - 894	18.5±1		
GSM	CP0805A0902BW	890 - 915	18±1		
	CP0805A0947BW	935 - 960	18±1		
E-GSM	CP0805A0897BW	880 - 915	18.5±1		
	CP0805A0942BW	925 - 960	18±1		
PDC	CP0805A1441BW	1429 - 1453	14.5±1	0.35	
PCN	CP0805A1747BW	1710 - 1785	12.5±1	0.5	1.4
	CP0805A1842BW	1805 - 1880	12.5±1	0.6	
PCS	CP0805A1880BW	1850 - 1910	12±1	0.6	
	CP0805A1960BW	1930 - 1990	11.5±1	0.7	
PHP	CP0805A1907BW	1895 - 1920	12±1	0.6	
DECT	CP0805A1890BW	1880 - 1900	12±1		
Wireless LAN	CP0805A2442BW	2400 - 2484	10±1	0.9	

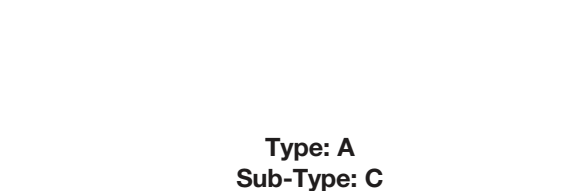

Type: A
Sub-Type: C

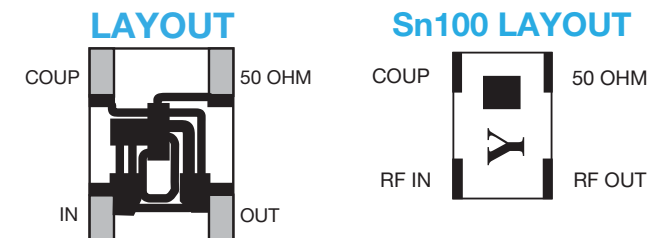
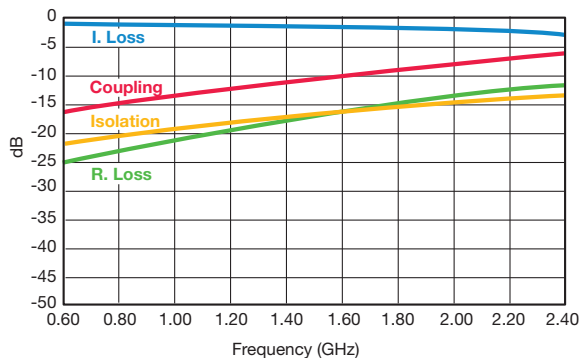

Application	P/N Examples	Frequency Band [MHz]	Coupling [dB]	I. Loss max	VSWR max
AMPS	CP0805A0836CW	824 - 849	14±1	0.5	1.4
	CP0805A0881CW	869 - 894	13.5±1		
GSM	CP0805A0902CW	890 - 915	13.5±1		
	CP0805A0947CW	935 - 960	13±1		
E-GSM	CP0805A0897CW	880 - 915	13.5±1		
	CP0805A0942CW	925 - 960	13±1		
PDC	CP0805A1441CW	1429 - 1453	9.5±1	1.15	1.8
PCN	CP0805A1747CW	1710 - 1785	8±1	1.6	2.2
	CP0805A1842CW	1805 - 1880	8±1	1.75	
PCS	CP0805A1880CW	1850 - 1910	7.5±1		
	CP0805A1960CW	1930 - 1990	7.5±1		
PHP	CP0805A1907CW	1895 - 1920	7.5±1		
DECT	CP0805A1890CW	1880 - 1900	7.5±1		
Wireless LAN	CP0805A2442CW	2400 - 2484	6±1	2.5	

Important: Couplers can be used at any frequency within the indicated range.



Thin-Film Directional Couplers



CP0805 Layout Types

LAYOUT

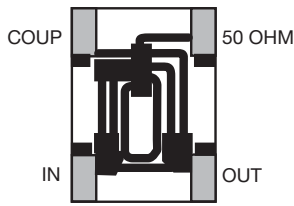

Sn100 LAYOUT

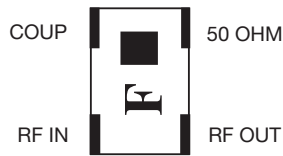

Type: A
Sub-Type: D

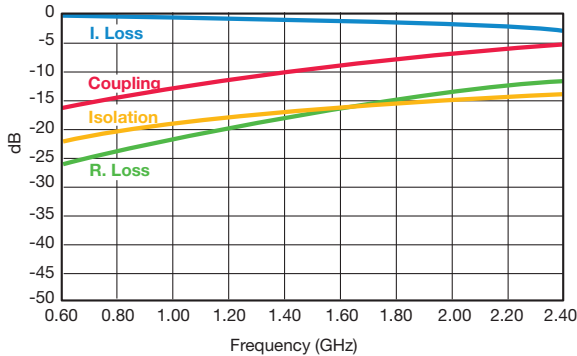

LAYOUT

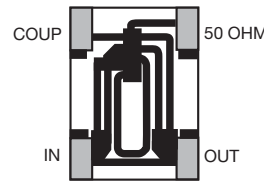

Sn100 LAYOUT

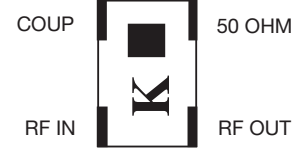

Type: A
Sub-Type: E

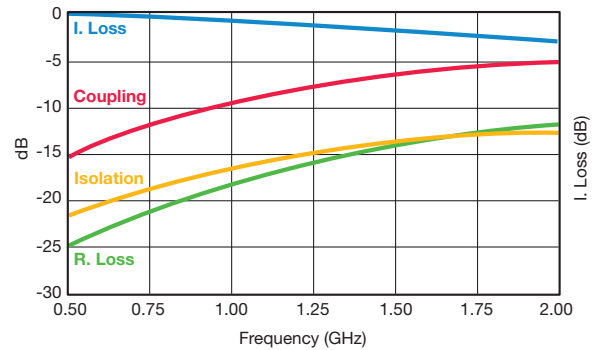

3

Application	P/N Examples	Frequency Band [MHz]	Coupling [dB]	I. Loss max	VSWR max
AMPS	CP0805A0836DW	824 - 849	13.0±1	0.5	1.4
	CP0805A0881DW	869 - 894	12.5±1		
GSM	CP0805A0902DW	890 - 915	12.5±1		
	CP0805A0947DW	935 - 960	12±1		
E-GSM	CP0805A0897DW	880 - 915	12.5±1		
	CP0805A0942DW	925 - 960	12±1		
PDC	CP0805A1441DW	1429 - 1453	8.5±1	1.25	1.8
PCN	CP0805A1747DW	1710 - 1785	7±1	1.85	
	CP0805A1842DW	1805 - 1880	7±1		
PCS	CP0805A1880DW	1850 - 1910	7±1		2.15
	Cp0805A1960DW	1930 - 1990	6.5±1		
PHP	CP0805A1907DW	1895 - 1920	6.5±1	1.85	1.8
DECT	CP0805A1890DW	1880 - 1900	7±1		
Wireless LAN	CP0805A2442DW	2400 - 2484	5.5±1	2.4	2.1

Application	P/N Examples	Frequency Band [MHz]	Coupling [dB]	I. Loss max	VSWR max
AMPS	CP0805A0836EW	824 - 849	11±1	0.85	1.4
	CP0805A0881EW	869 - 894	10.5±1		
GSM	CP0805A0902EW	890 - 915	10.5±1		
	CP0805A0947EW	935 - 960	10±1		
E-GSM	CP0805A0897EW	880 - 915	10.5±1		
	CP0805A0942EW	925 - 960	10±1		
PDC	CP0805A1441EW	1429 - 1453	7±1	1.8	1.8
PCN	CP0805A1747EW	1710 - 1785	5.5±1	2.7	
	CP0805A1842EW	1805 - 1880	5.5±1		
PCS	CP0805A1880EW	1850 - 1910	5±1		3.15
	Cp0805A1960EW	1930 - 1990	5±1		
PHP	CP0805A1907EW	1895 - 1920	5±1	4.2	
DECT	CP0805A1890EW	1880 - 1900	5±1		
Wireless LAN	CP0805A2442EW	2400 - 2484	4±1		

Type: B
Sub-Type: A

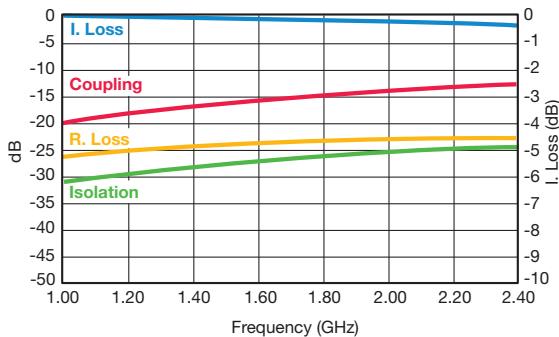

LAYOUT

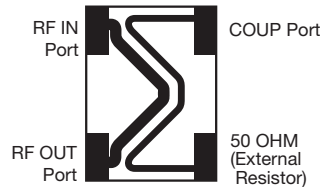

Sn100 LAYOUT

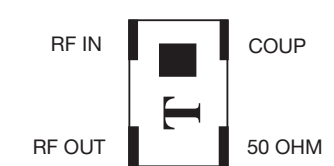

Application	P/N Examples	Frequency Band [MHz]	Coupling [dB]	I. Loss max	VSWR max
AMPS	CP0805B0836AW	824 - 849	21.5±1	0.25	1.2
	CP0805B0881AW	869 - 894	21±1		
GSM	CP0805B0902AW	890 - 915	21±1		
	CP0805B0947AW	935 - 960	20.5±1		
E-GSM	CP0805B0897AW	880 - 915	21±1		
	CP0805B0942AW	925 - 960	20.5±1		
PDC	CP0805B1441AW	1429 - 1453	17±1	0.3	
PCN	CP0805B1747AW	1710 - 1785	15.5±1		
	CP0805B1842AW	1805 - 1880	15.5±1		
PCS	CP0805B1880AW	1850 - 1910	15±1	0.4	
	CP0805B1960AW	1930 - 1990	14.5±1		
PHP	CP0805B1907AW	1895 - 1920	15±1	0.3	
DECT	CP0805B1890AW	1880 - 1900	15±1		
Wireless LAN	CP0805B2442AW	2400 - 2484	13±1	0.4	

Important: Couplers can be used at any frequency within the indicated range.



Thin-Film Directional Couplers



CP0805 Layout Types

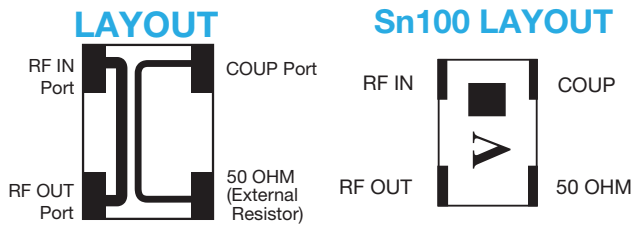

Type: B
Sub-Type: B

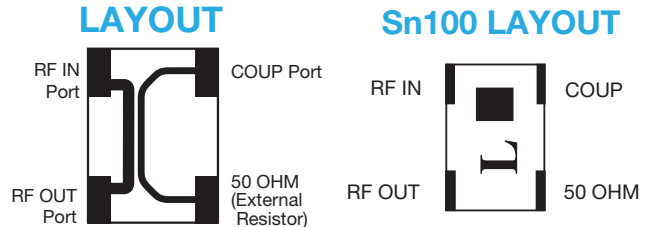
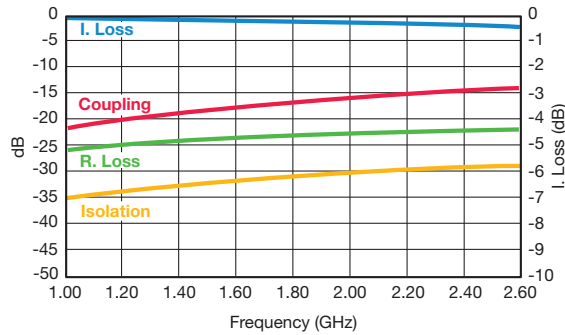

Type: B
Sub-Type: C

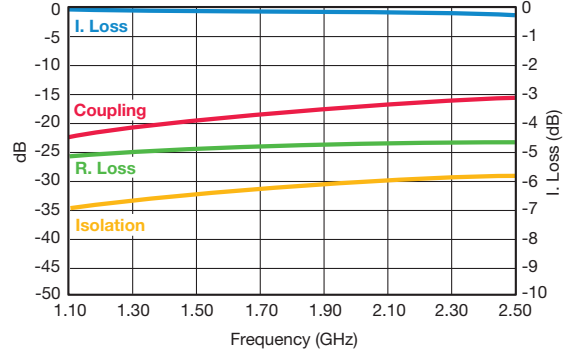

Application	P/N Examples	Frequency Band [MHz]	Coupling [dB]	I. Loss max	VSWR max
AMPS	CP0805B0836BW	824 - 849	23.5±1	0.25	1.2
	CP0805B0881BW	869 - 894	23±1		
GSM	CP0805B0902BW	890 - 915	22.5±1		
	CP0805B0947BW	935 - 960	22±1		
E-GSM	CP0805B0897BW	880 - 915	23±1		
	CP0805B0942BW	925 - 960	22±1		
PDC	CP0805B1441BW	1429 - 1453	18.5±1		
PCN	CP0805B1747BW	1710 - 1785	17±1		
	CP0805B1842BW	1805 - 1880	16.5±1		
PCS	CP0805B1880BW	1850 - 1910	16.5±1		
	CP0805B1960BW	1930 - 1990	16±1		
PHP	CP0805B1907BW	1895 - 1920	16±1		
DECT	CP0805B1890BW	1880 - 1900	16±1		
Wireless LAN	CP0805B2442BW	2400 - 2484	14±1	0.4	

Application	P/N Examples	Frequency Band [MHz]	Coupling [dB]	I. Loss max	VSWR max
AMPS	CP0805B0836CW	824 - 849	25±1	0.25	1.2
	CP0805B0881CW	869 - 894	24.5±1		
GSM	CP0805B0902CW	890 - 915	24±1		
	CP0805B0947CW	935 - 960	24±1		
E-GSM	CP0805B0897CW	880 - 915	24.5±1		
	CP0805B0942CW	925 - 960	24±1		
PDC	CP0805B1441CW	1429 - 1453	20±1		
PCN	CP0805B1747CW	1710 - 1785	18.5±1		
	CP0805B1842CW	1805 - 1880	18.5±1		
PCS	CP0805B1880CW	1850 - 1910	18±1		
	CP0805B1960CW	1930 - 1990	17.5±1		
PHP	CP0805B1907CW	1895 - 1920	18±1		
DECT	CP0805B1890CW	1880 - 1900	18±1		
Wireless LAN	CP0805B2442CW	2400 - 2484	16±1	0.4	

3

Important: Couplers can be used at any frequency within the indicated range.



Thin-Film Directional Couplers



CP0805 and CP0603 Test Jig

ITF TEST JIG FOR COUPLER TYPES 0805 AND 0603 SMD

GENERAL DESCRIPTION

This jig is designed for the testing of CP0805 and CP0603 series Directional Couplers using a vector network analyzer. It consists of a FR4 multi-layer substrate, having 50Ω microstrips as conducting lines and a ground plane in the middle layer, located at a distance of 0.2mm from the microstrips.

The connectors are SMA type (female), 'Johnson Components Inc.' Product P/N: 142-0701-881.

The jig is designed for a full 2-port calibration. LOAD calibration can be done either by a 50Ω SMA termination, or by soldering a 50Ω chip resistor at the 50Ω ports.

MEASUREMENT PROCEDURE

When measuring a component, it can be either soldered or pressed by a non-metallic stick until all four ports touch the appropriate pads. To measure the coupling (and the R. Loss) place the component on the Port 1 & Port 2 pads. Use two SMA 50Ω terminations (male) to terminate the ports, which are not connected to the network analyzer, and connect the network analyzer to the two ports. A 90° rotation of the component on its pads allows measuring a second parameter (I. Loss).

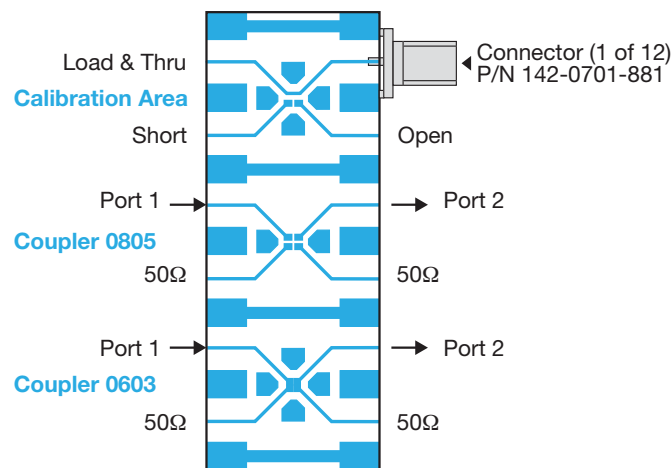

CP0805 SERIES DIRECTIONAL COUPLERS

Orientation and Tape and Reel Packaging (Top View)

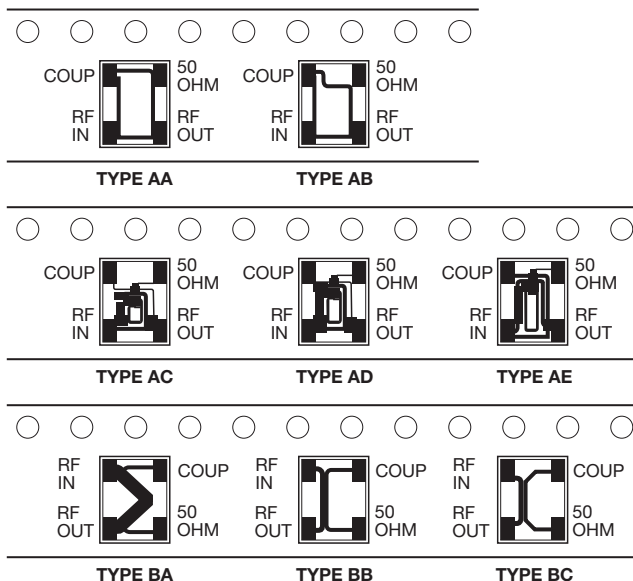

The parts should be mounted on the PCB with White (Alumina) side down and the "dark" side up.

CP0805xxxxxxSTR (Sn100) (Top View)

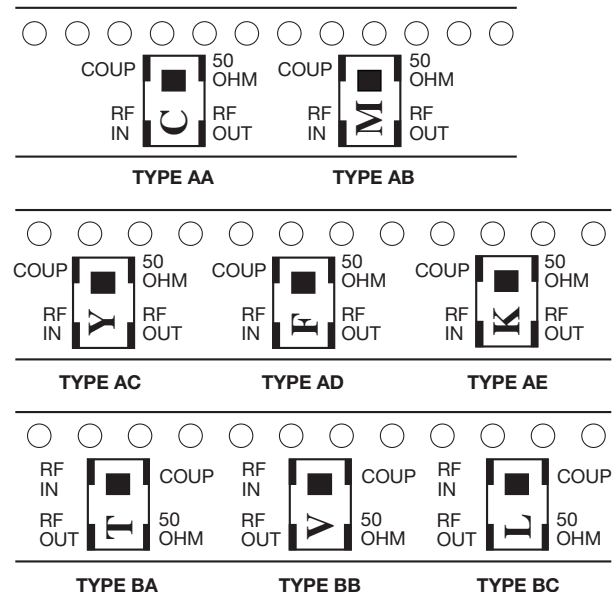

The parts should be mounted on the PCB with printed side up.

Thin-Film Directional Couplers

DB0603N 3dB 90° Couplers



GENERAL DESCRIPTION RFAP TECHNOLOGY

The DB0603N 3dB 90° Coupler is based on thin-film multilayer technology. The technology provides a miniature part with excellent high frequency performance and rugged construction for reliable automatic assembly.

The RFAP LGA 3dB 90° Coupler will be offered in a variety of frequency bands compatible with various types of high frequency wireless systems.

APPLICATIONS

- Balanced Amplifiers and Signal Distribution in Wireless Communications

Recommended Pad Layout Dimensions mm (inches)

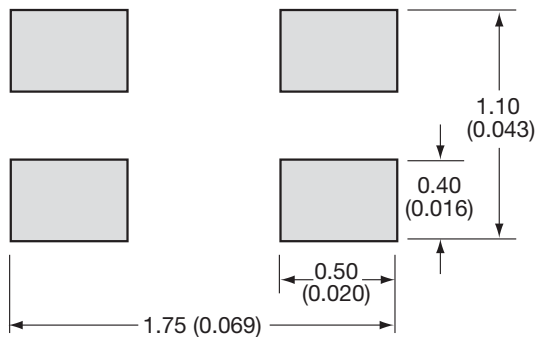

FEATURES

- Miniature 0603 size
- Low I. Loss
- High Isolation
- Surface Mountable
- RoHS Compliant
- Supplied on T&R

LAND GRID ARRAY ADVANTAGES:

- Inherent Low Profile
- Self Alignment during Reflow
- Excellent Solderability
- Low Parasitics
- Better Heat Dissipation

DIMENSIONS:

millimeters (inches)

L	1.60±0.10 (0.063±0.004)
W	0.84±0.10 (0.033±0.004)
T	0.60±0.10 (0.024±0.004)
A	0.25±0.05 (0.010±0.002)
B	0.20±0.05 (0.008±0.002)
S	0.05±0.05 (0.002±0.002)

Bottom View

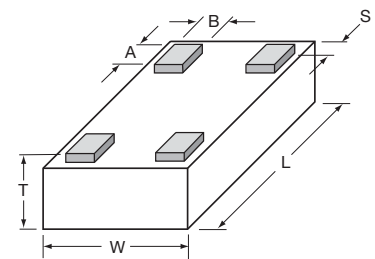

ORIENTATION IN TAPE

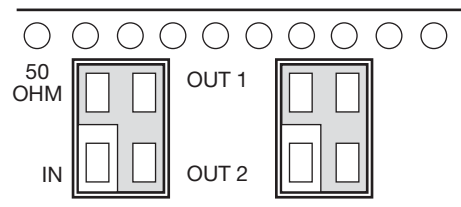

ELECTRICAL PARAMETERS

Part Number	Frequency MHz		Port Impedance Ω	Return Loss [dB]		Isolation [dB]		Insertion Loss [dB]		Amplitude Balance [dB]		Phase Balance (Relative to 90°) Deg		Power Handling Watts
	Min.	Max.		Min.	Typ.	Min.	Typ.	Typ.	Max.	Typ.	Max.	Typ.	Max.	
DB0603N2140ANTR	2040	2240	50	15	26	15	23	0.30	0.40	0.50	0.80	2	3	3
DB0603N2400ANTR	2300	2500	50	12	17	15	23	0.25	0.35	0.30	0.80	2	3	3
DB0603N3000ANTR	2850	3150	50	12	15	15	26	0.20	0.30	0.30	0.80	2	3	3
DB0603N3500ANTR	3300	3700	50	12	15	15	26	0.20	0.30	0.30	0.80	2	3	3

Thin-Film Directional Couplers

DB0603N 3dB 90° Couplers



2040MHz to 2240MHz DB0603N2140ANTR

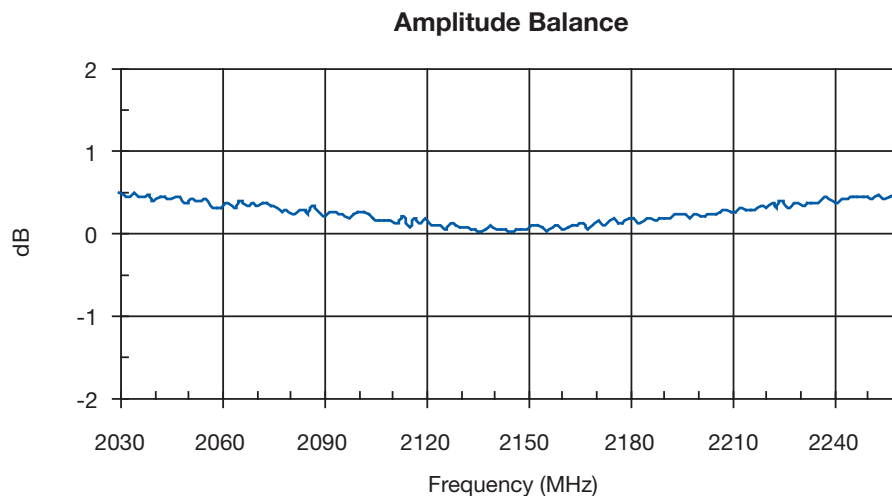
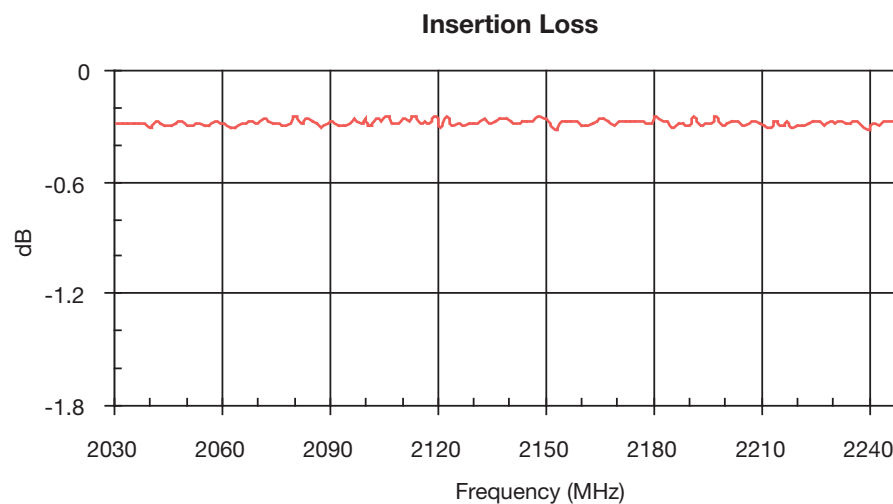
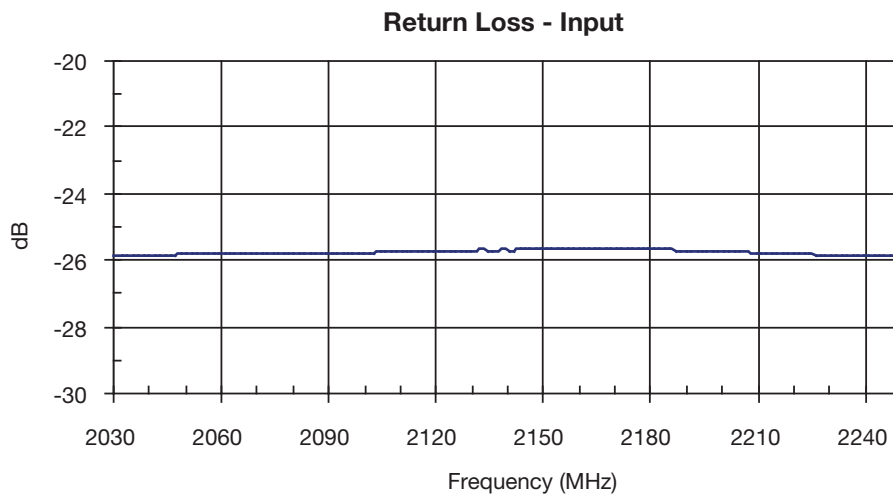

3

Thin-Film Directional Couplers

DB0603N 3dB 90° Couplers



2040MHz to 2240MHz DB0603N2140ANTR

Phase Balance

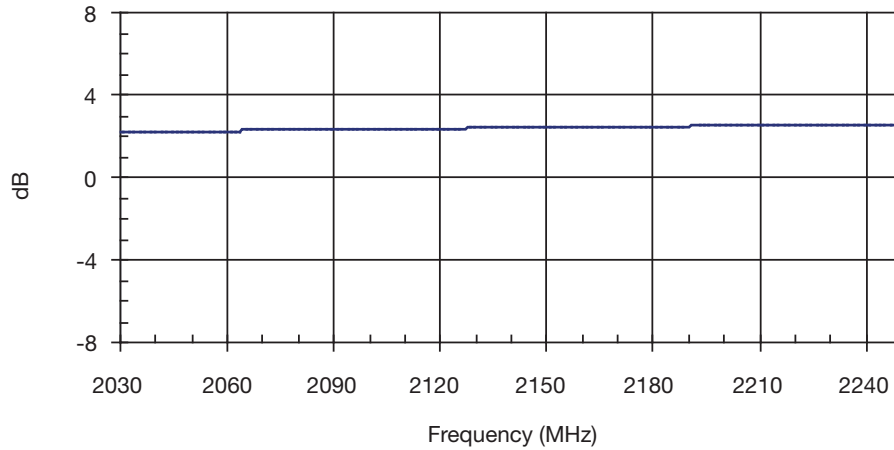

Isolation

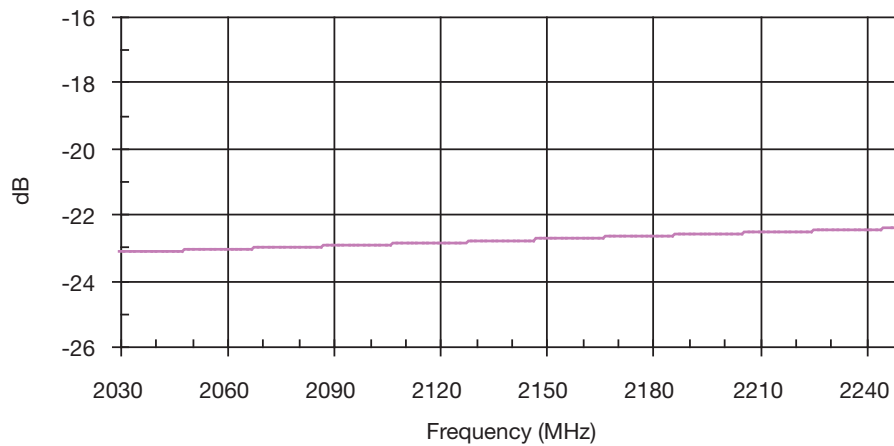

3

Thin-Film Directional Couplers

DB0603N 3dB 90° Couplers



2200MHz to 2600MHz DB0603N2400ANTR

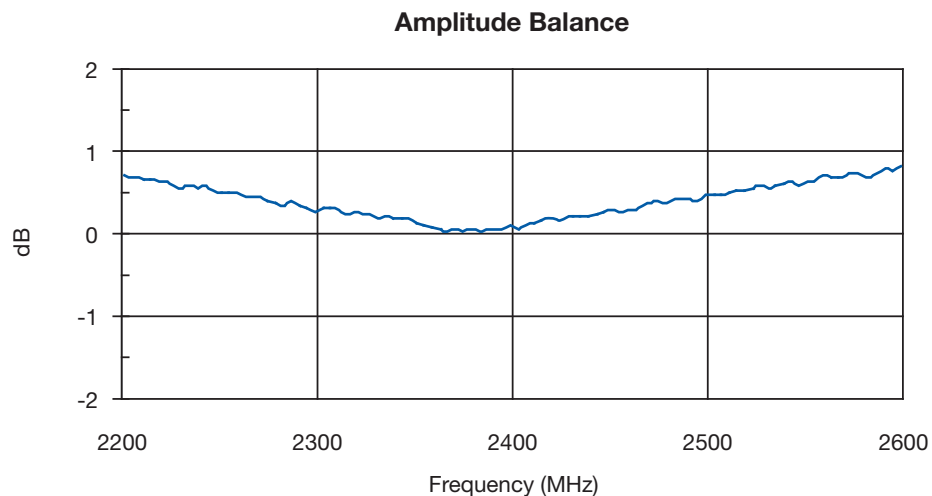
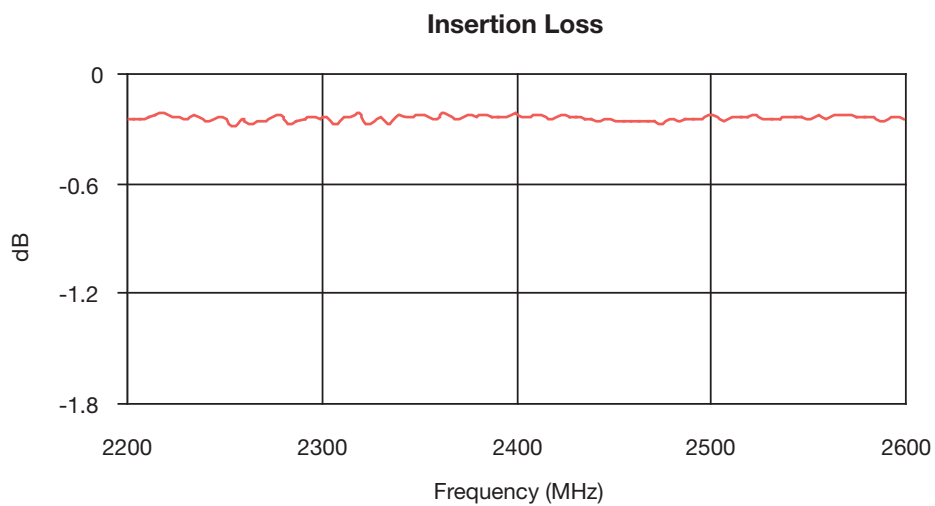
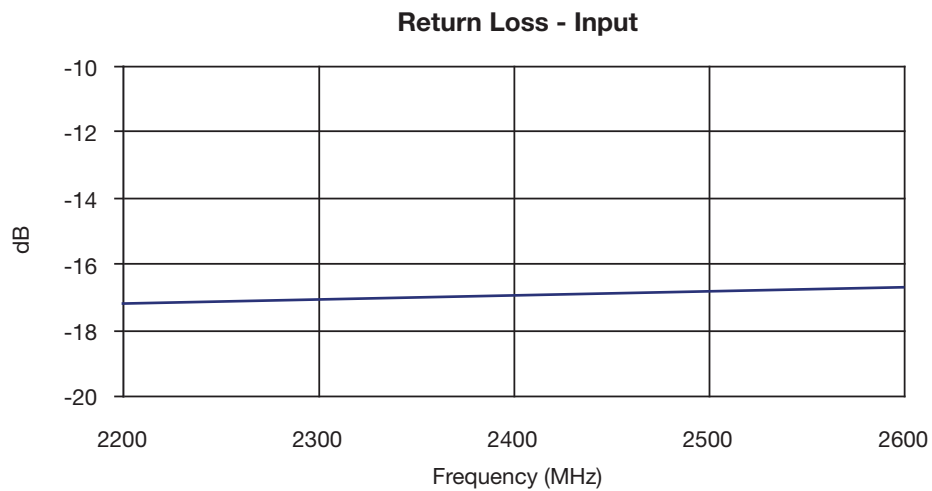

3



Thin-Film Directional Couplers

DB0603N 3dB 90° Couplers



2200MHz to 2600MHz DB0603N2400ANTR

Phase Balance

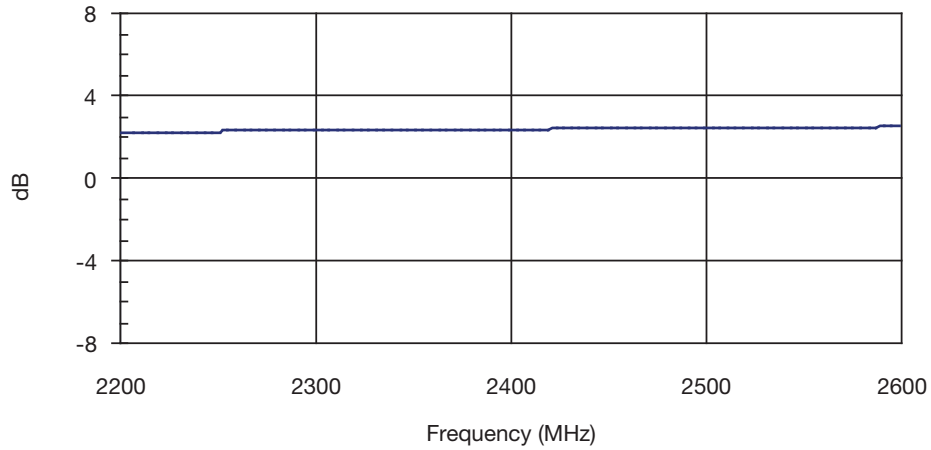

Isolation

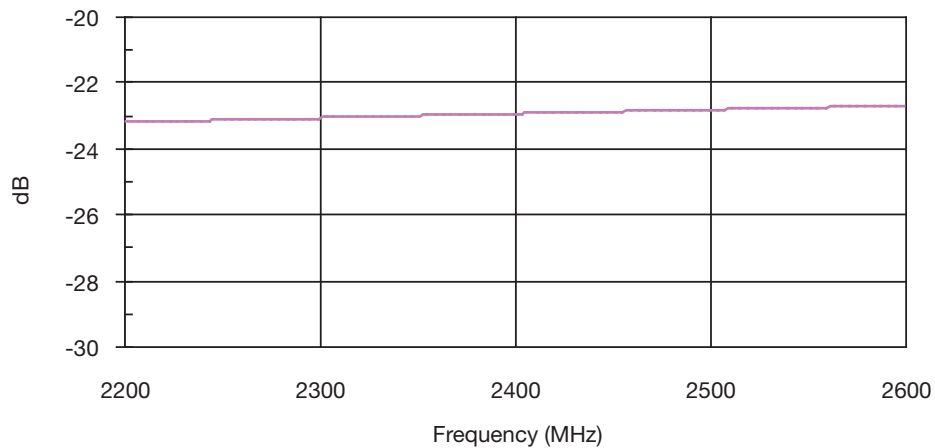

3

Thin-Film Directional Couplers

DB0603N 3dB 90° Couplers



2850MHz to 3150MHz DB0603N3000ANTR

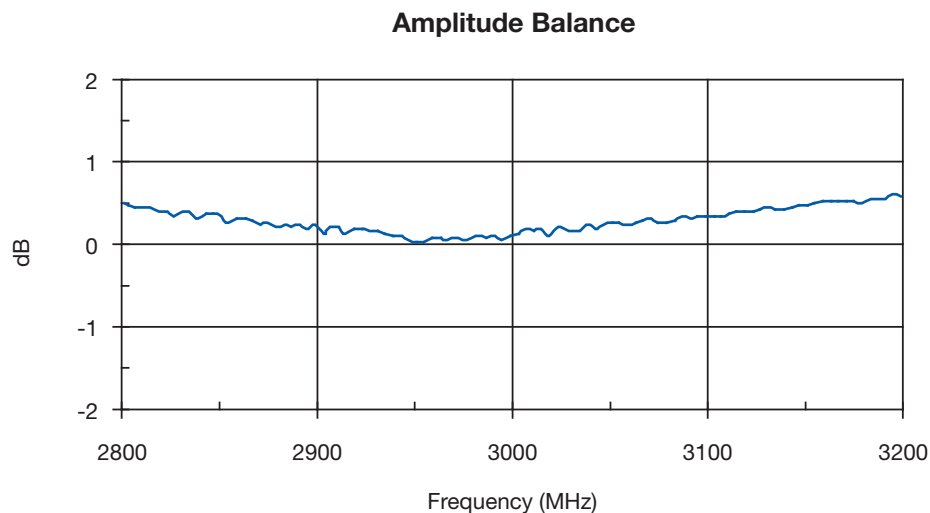
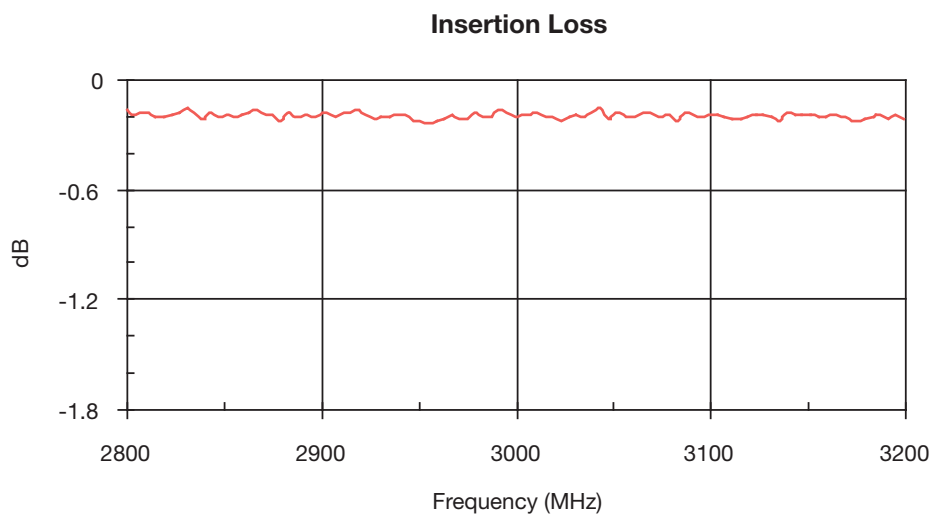
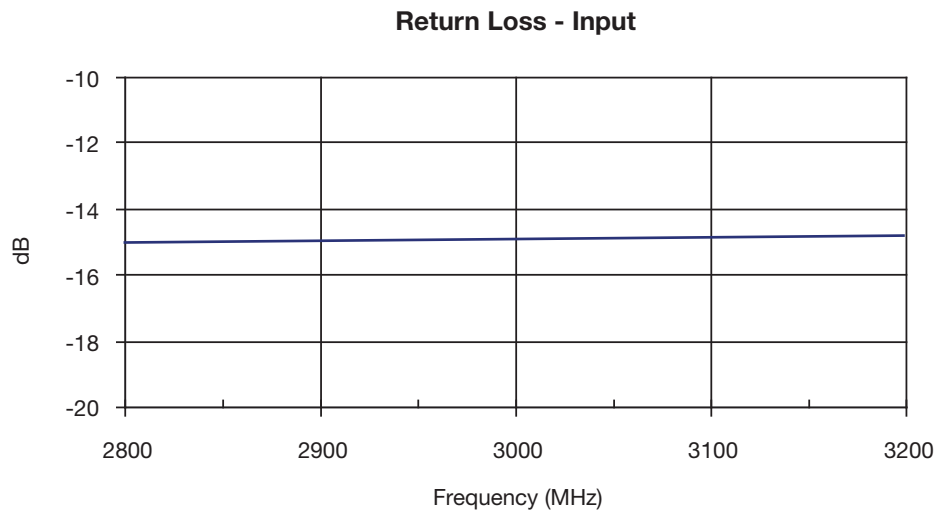

3



Thin-Film Directional Couplers

DB0603N 3dB 90° Couplers



2850MHz to 3150MHz DB0603N3000ANTR

Phase Balance

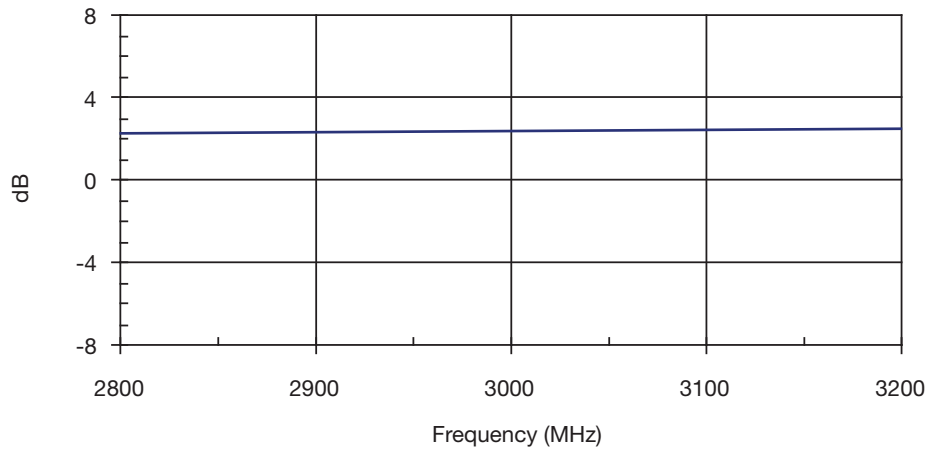

Isolation

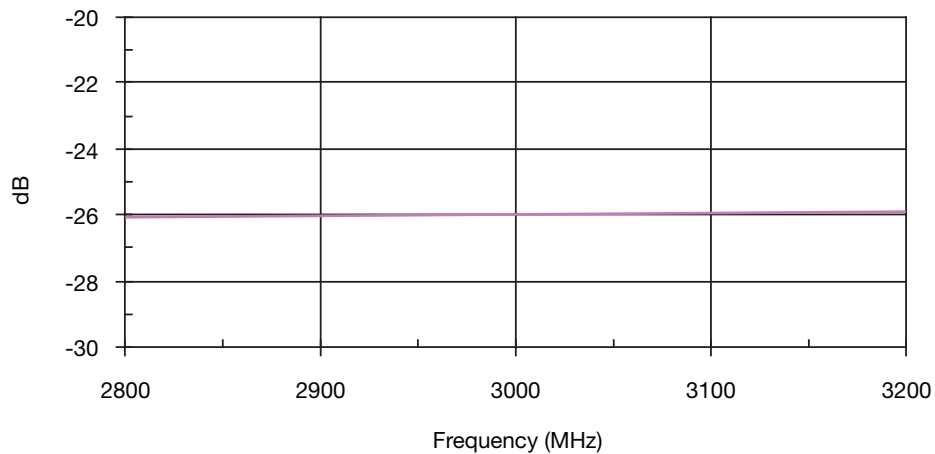

3

Thin-Film Directional Couplers

DB0603N 3dB 90° Couplers



3200MHz to 3800MHz DB0603N3500ANTR

Return Loss - Input

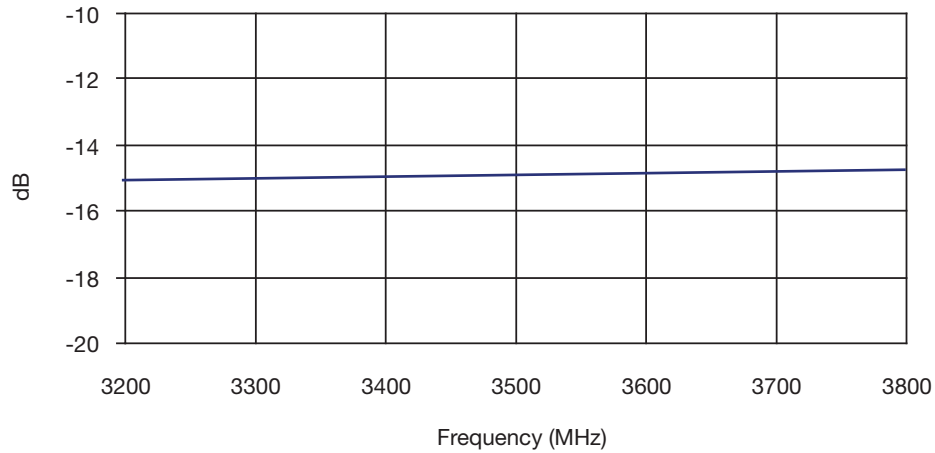

Insertion Loss

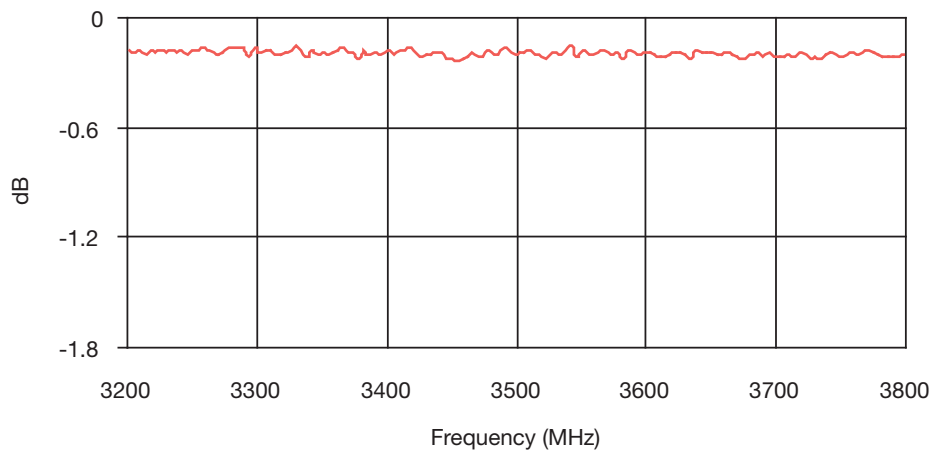

Amplitude Balance

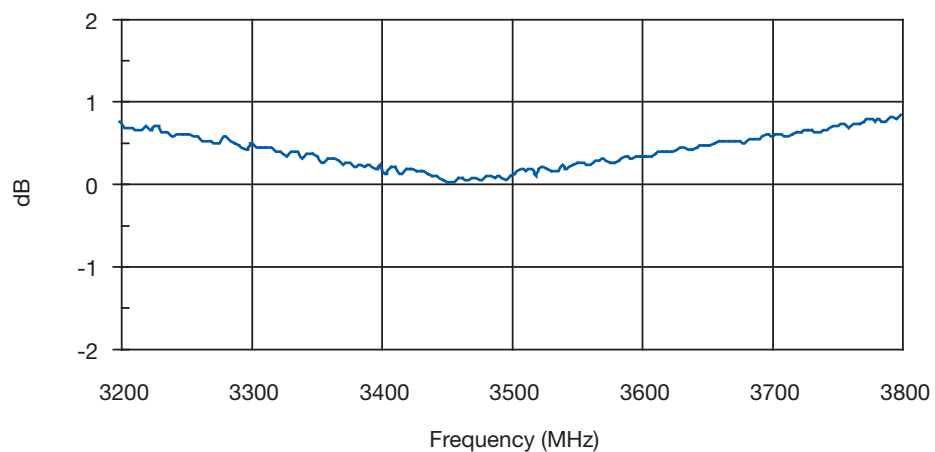

3



Thin-Film Directional Couplers

DB0603N 3dB 90° Couplers



3200MHz to 3800MHz DB0603N3500ANTR

Phase Balance

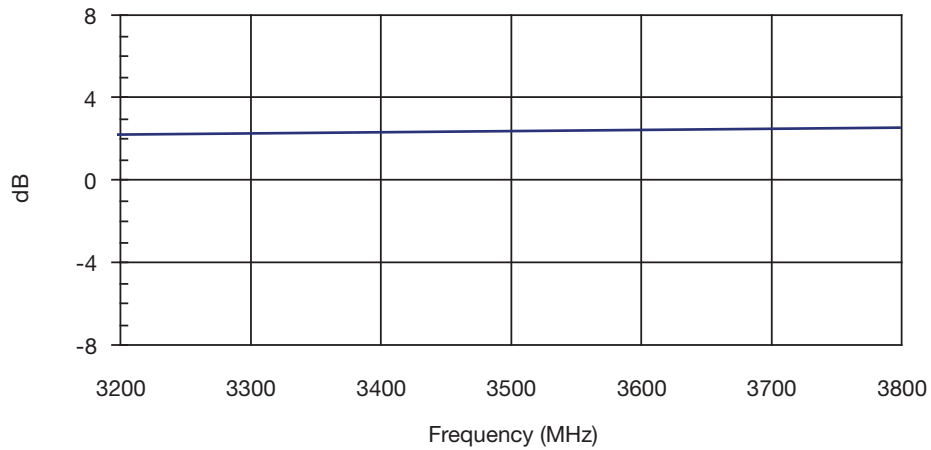

Isolation

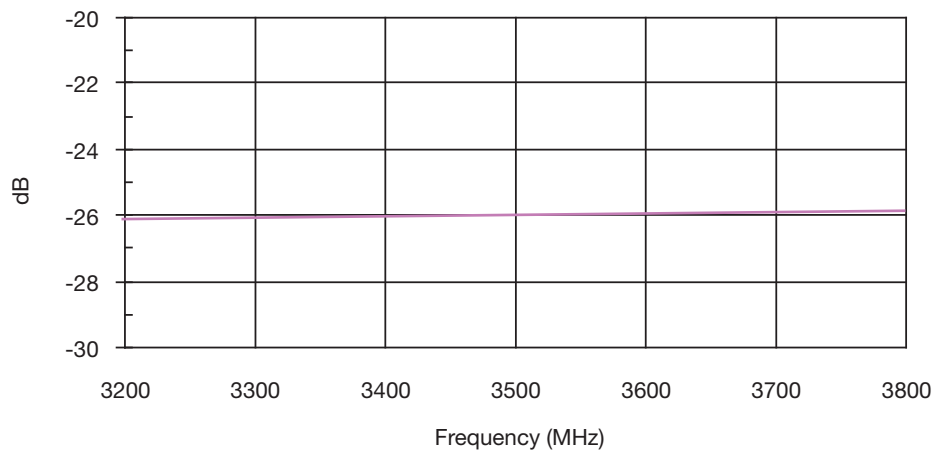

3

Thin-Film Directional Couplers

DB0805 3dB 90° Couplers



GENERAL DESCRIPTION ITF TECHNOLOGY

The ITF SMD 3dB 90° Coupler is based on thin-film multilayer technology. The technology provides a miniature part with excellent high frequency performance and rugged construction for reliable automatic assembly.

The ITF 3dB 90° Coupler is offered in a variety of frequency bands compatible with various types of high frequency wireless systems.

APPLICATIONS

- Balanced Amplifiers and Signal Distribution in Mobile Communications

FEATURES

- Miniature 0805 size
- Low I. Loss
- High Isolation
- Power Handling: 10W RF CW
- Surface Mountable
- Supplied on Tape and Reel
- Operating Temperature -40°C to +85°C

Recommended Pad Layout Dimensions mm (inches)

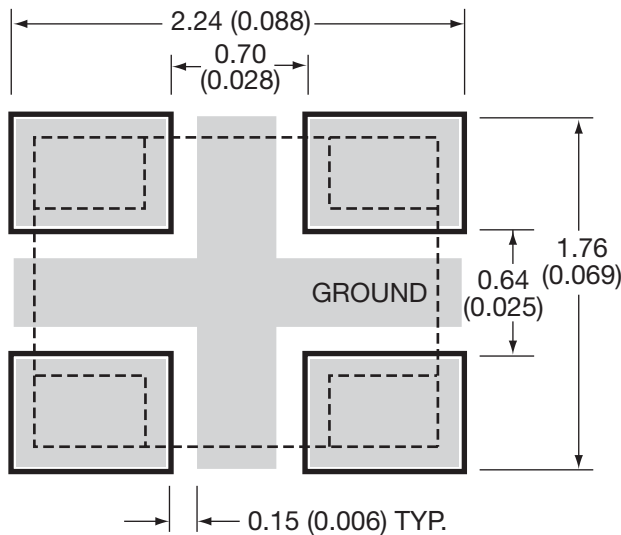

DIMENSIONS:

millimeters (inches)

L	2.03±0.10 (0.080±0.004)
W	1.55±0.10 (0.061±0.004)
T	0.98±0.15 (0.037±0.006)
A	0.56±0.25 (0.022±0.010)
B	0.35±0.15 (0.014±0.006)

Bottom View

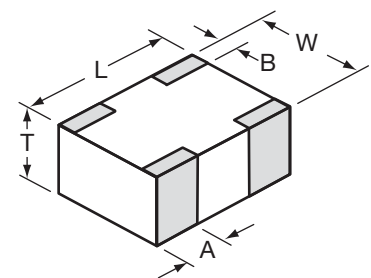

TERMINALS (Top View) Orientation in Tape

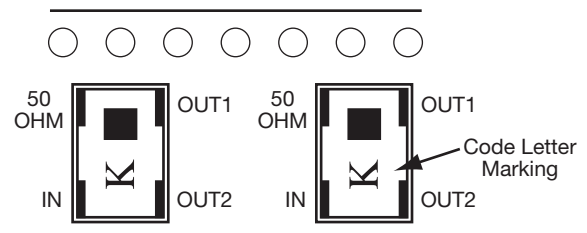

ELECTRICAL PARAMETERS*

Part Number**	Frequency F ₀ [MHz]	I. Loss @ F ₀ [dB]	Phase Balance [deg] max.	Code Letter Marking
DB0805A0880AWTR	880±30	0.35	3	Y
DB0805A0915AWTR	915±30	0.35	3	V
DB0805A0967AWTR	967±30	0.35	3	V
DB0805A1350AWTR	1350±50	0.35	3	C
DB0805A1650AWTR	1650±50	0.35	3	F
DB0805A1800AWTR	1800±50	0.30	3	F
DB0805A1850AWTR	1850±50	0.30	3	K
DB0805A1900AWTR	1900±50	0.30	3	K
DB0805A1950AWTR	1950±50	0.25	3	K
DB0805A2140AWTR	2140±50	0.25	3	L
DB0805A2325AWTR	2325±50	0.25	3	T

*With Recommended Pad Layout

**LEAD FREE TERMINATION
PART NUMBERS:
DB0805AxxxxASTR



Important: All intermediate frequencies within the indicated range are readily available.

Thin-Film Directional Couplers

DB0805 3dB 90° Couplers



880 ± 30MHz DB0805A0880AWTR

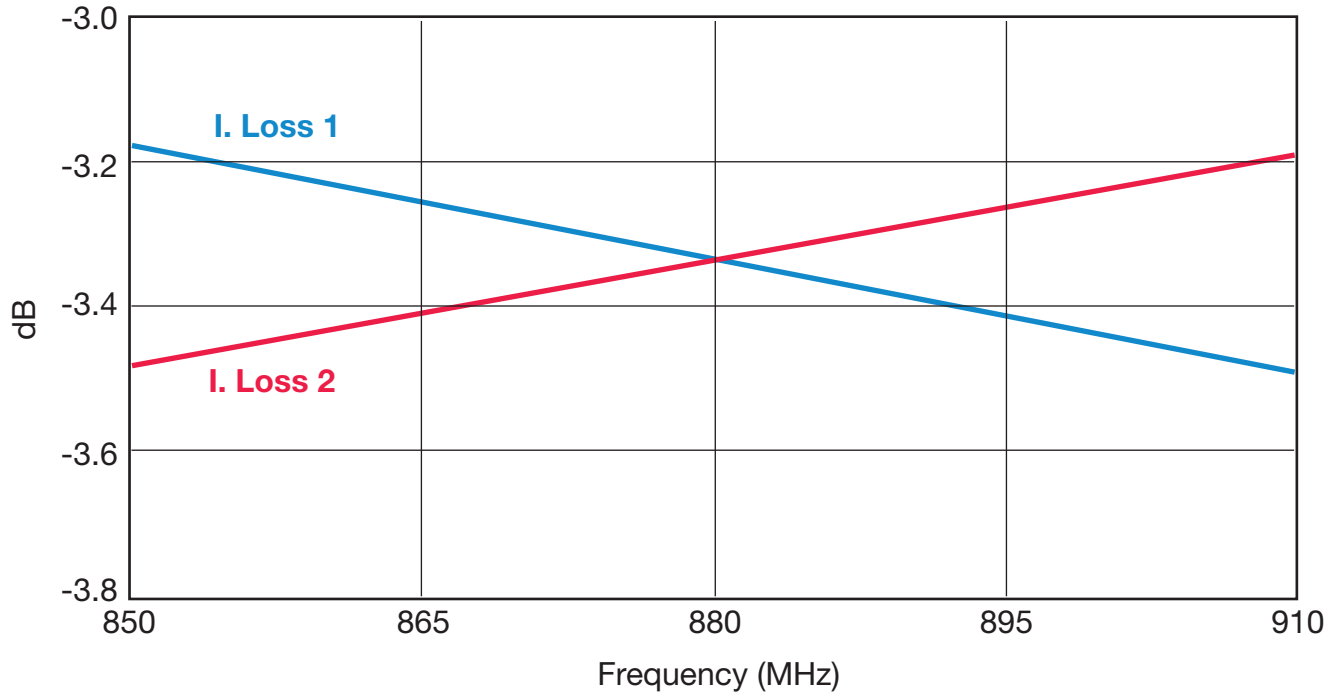

3

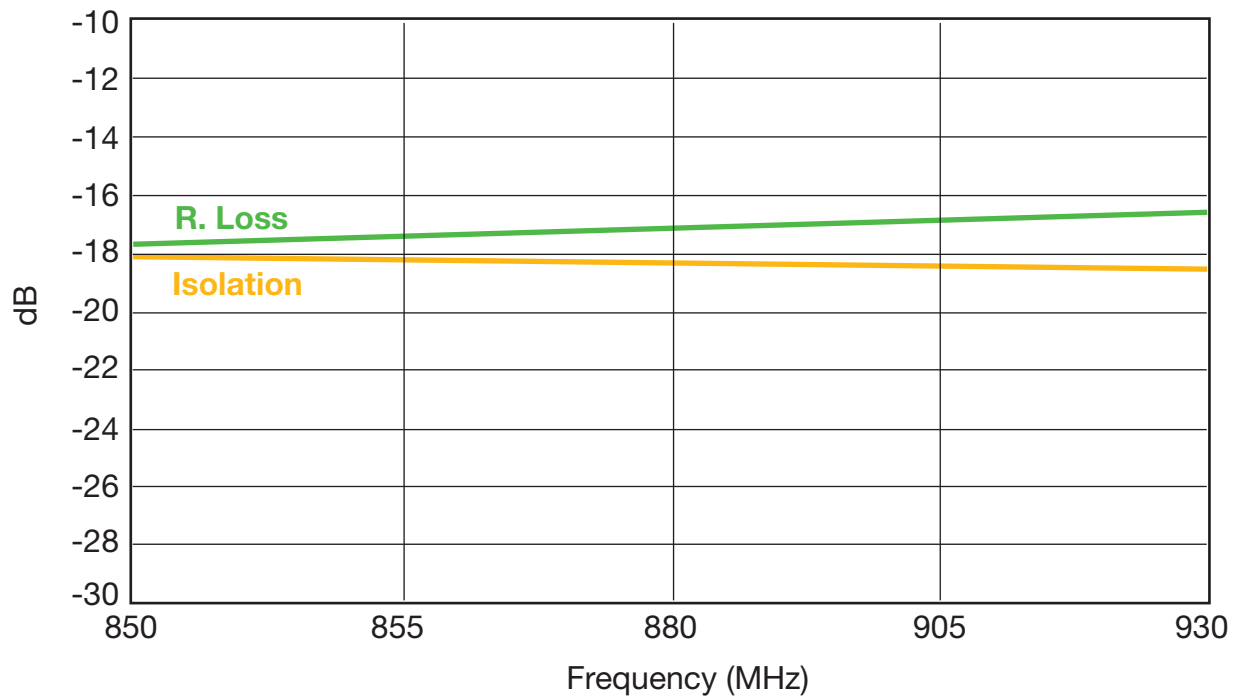

Thin-Film Directional Couplers

DB0805 3dB 90° Couplers



915 ± 30MHz DB0805A0915AWTR

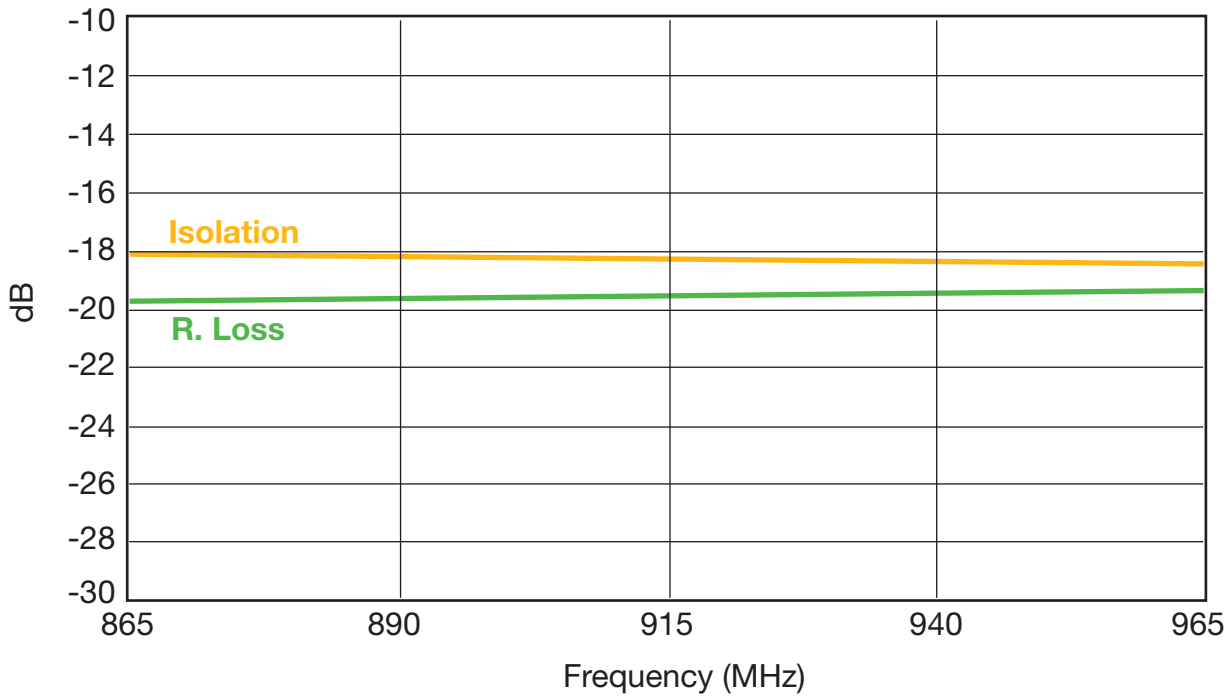
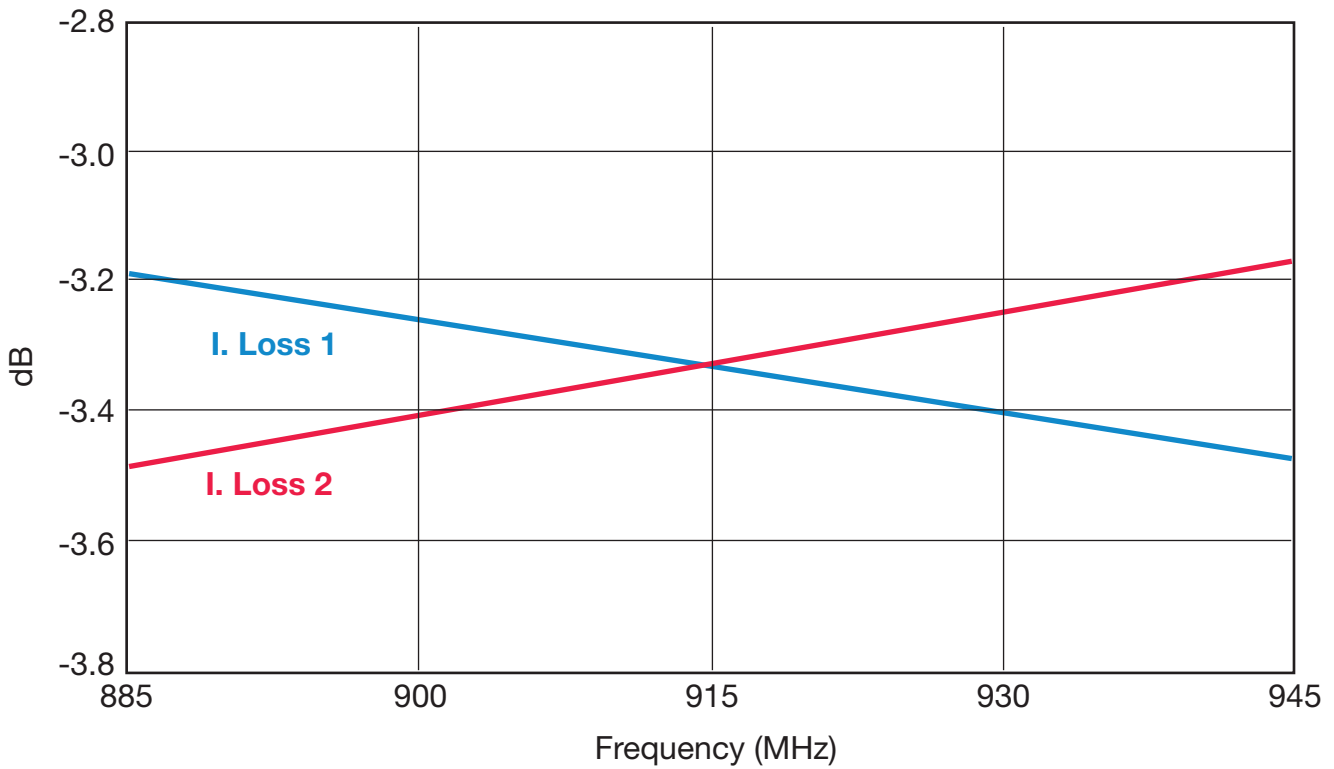

3

Thin-Film Directional Couplers

DB0805 3dB 90° Couplers



967± 30MHz DB0805A0967AWTR

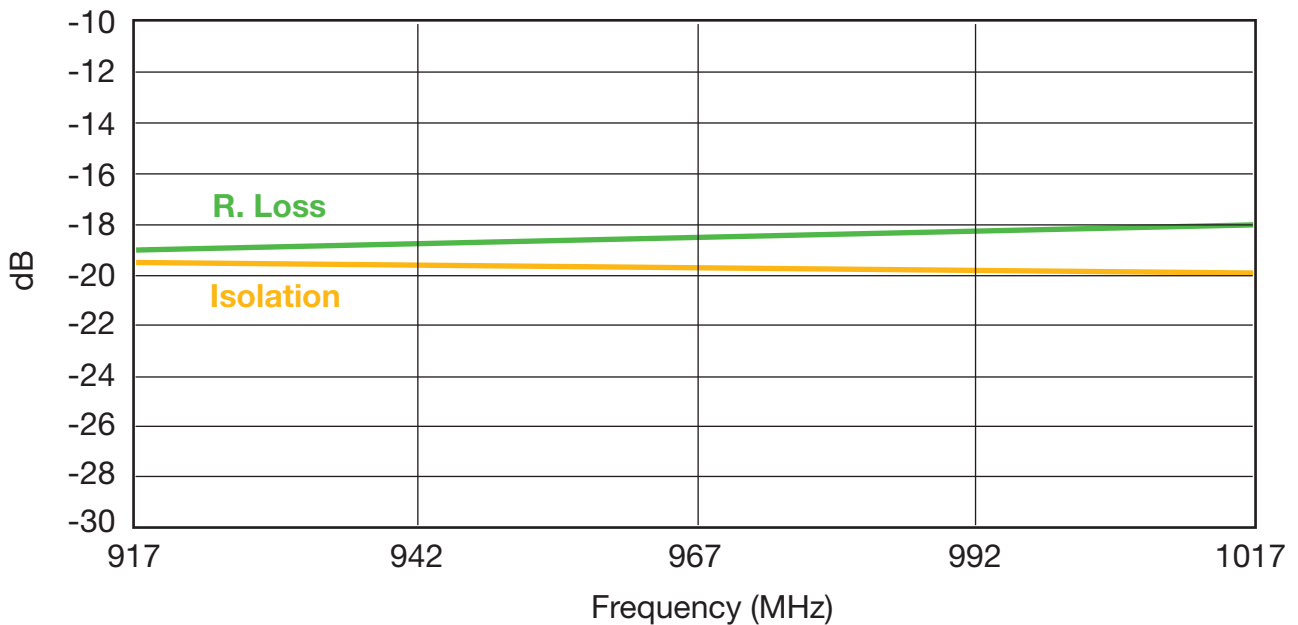
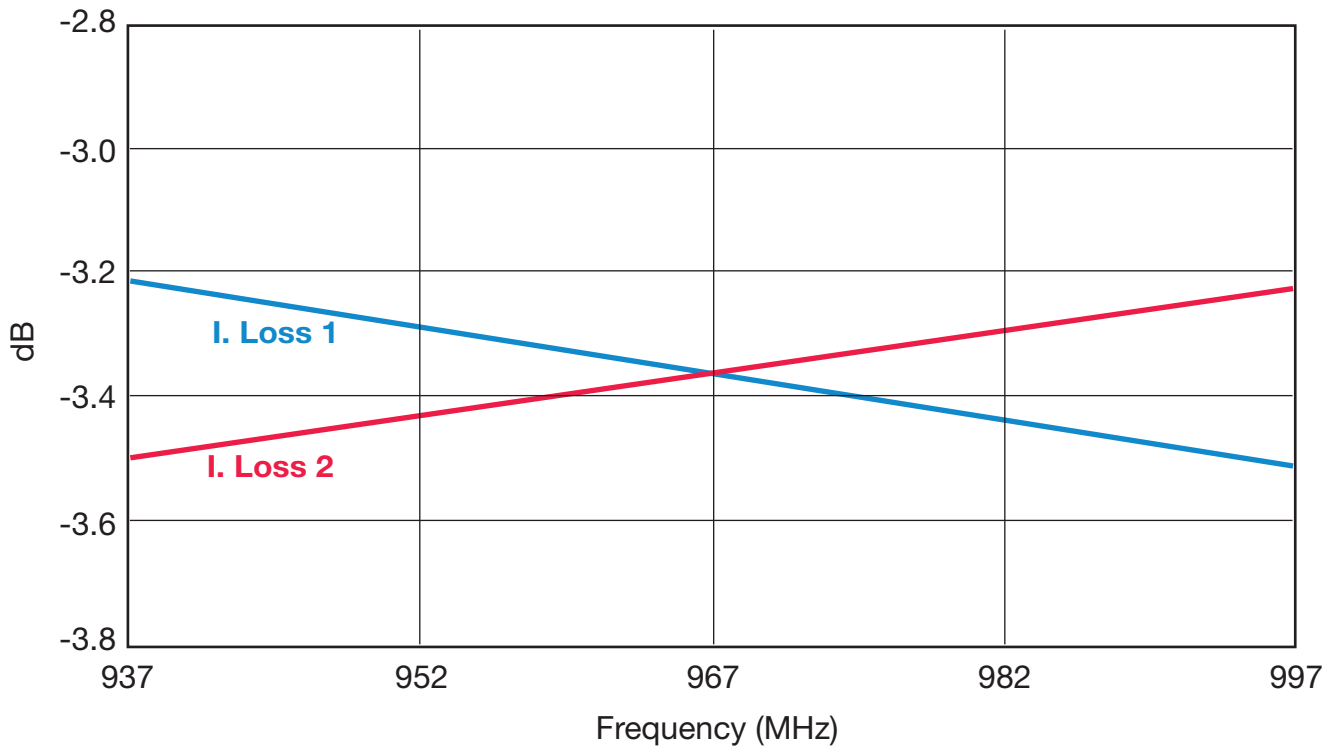

3

Thin-Film Directional Couplers

DB0805 3dB 90° Couplers



1350 ± 50MHz DB0805A1350AWTR

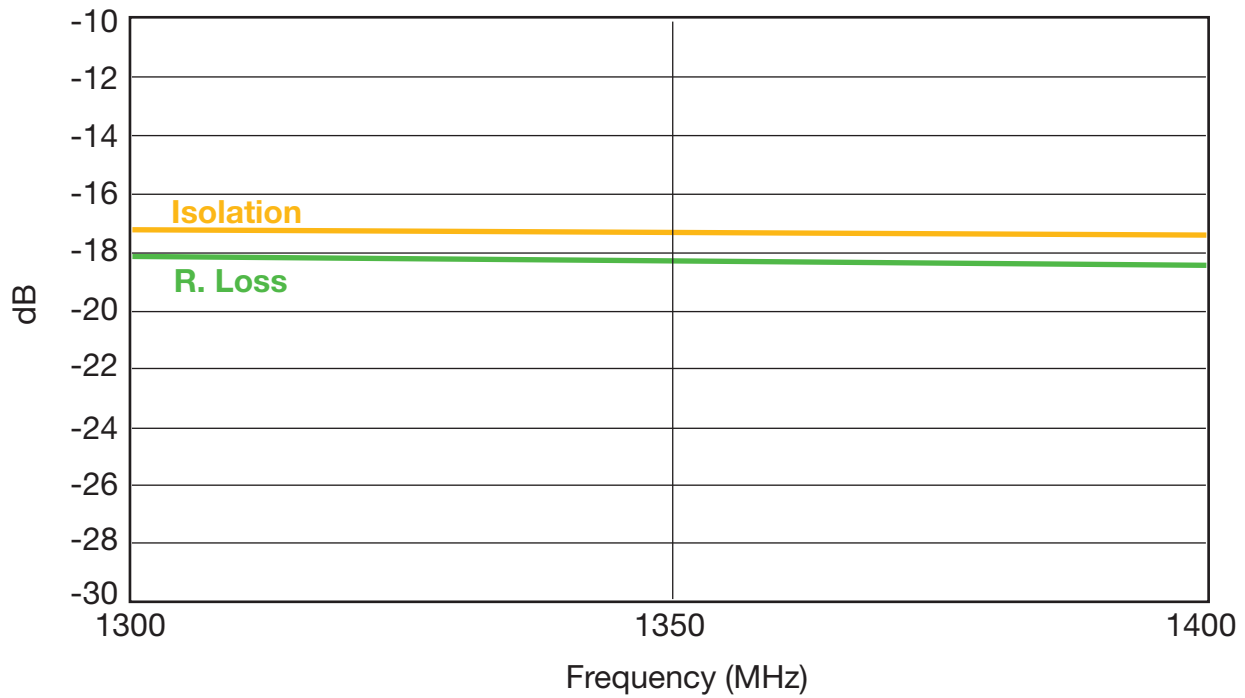
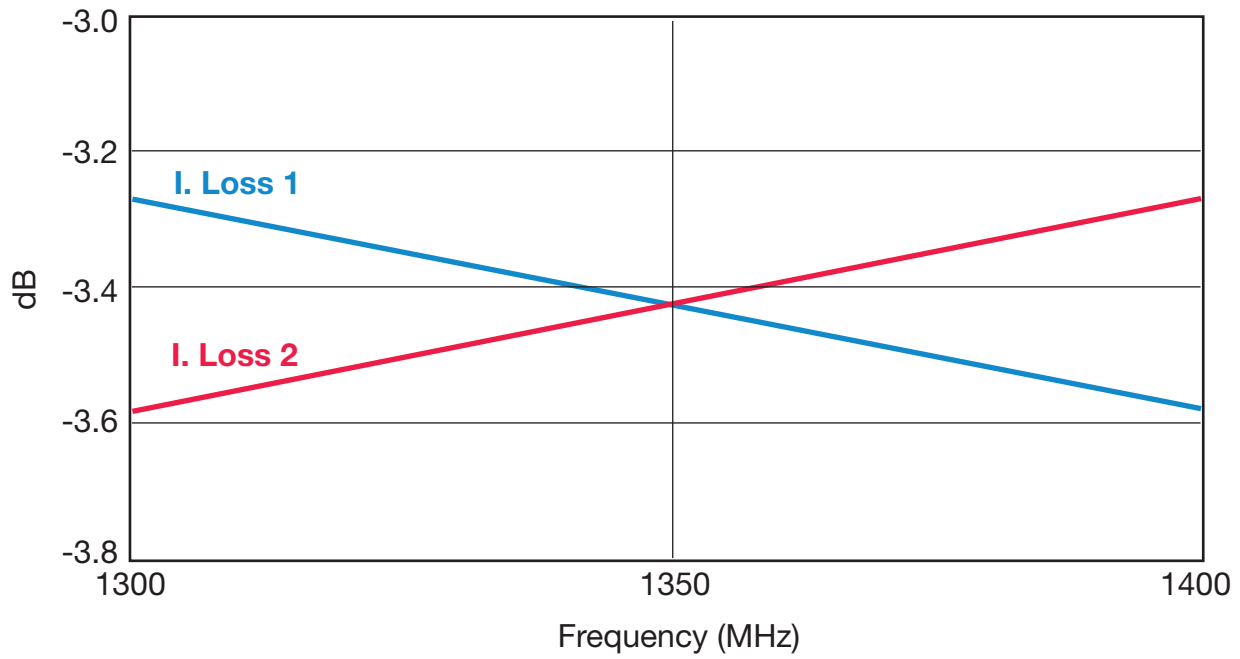

3

Thin-Film Directional Couplers

DB0805 3dB 90° Couplers



1650 ± 50MHz DB0805A1650AWTR

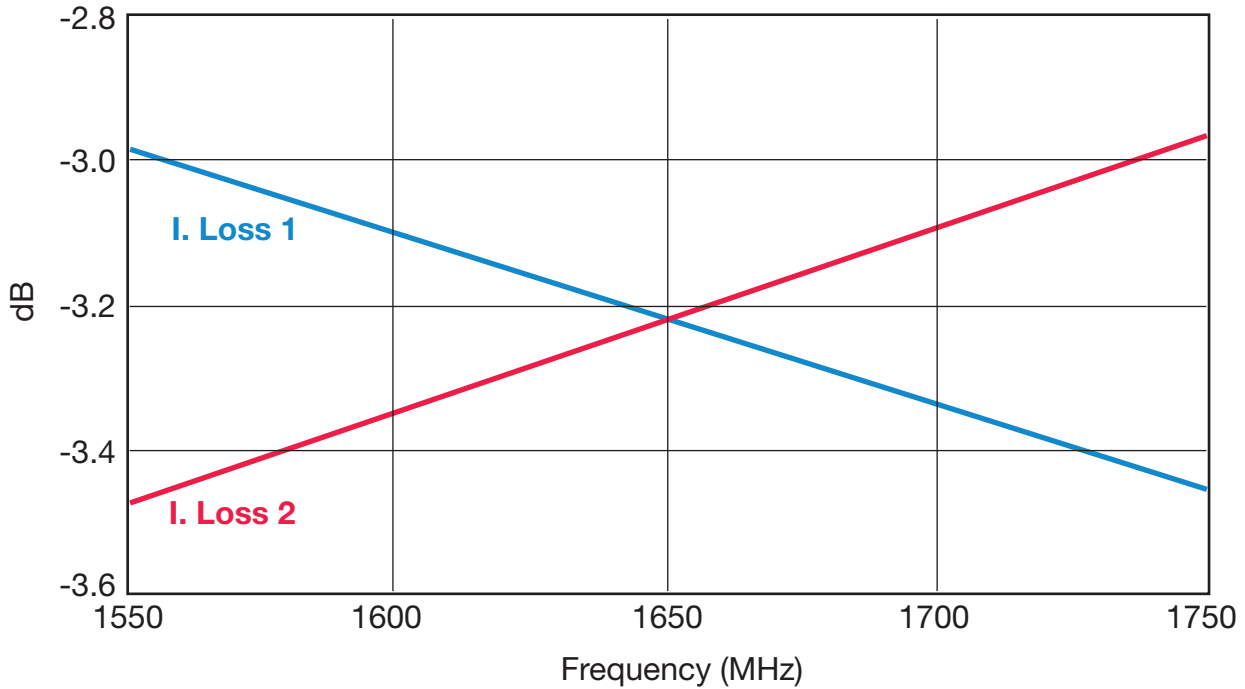

3

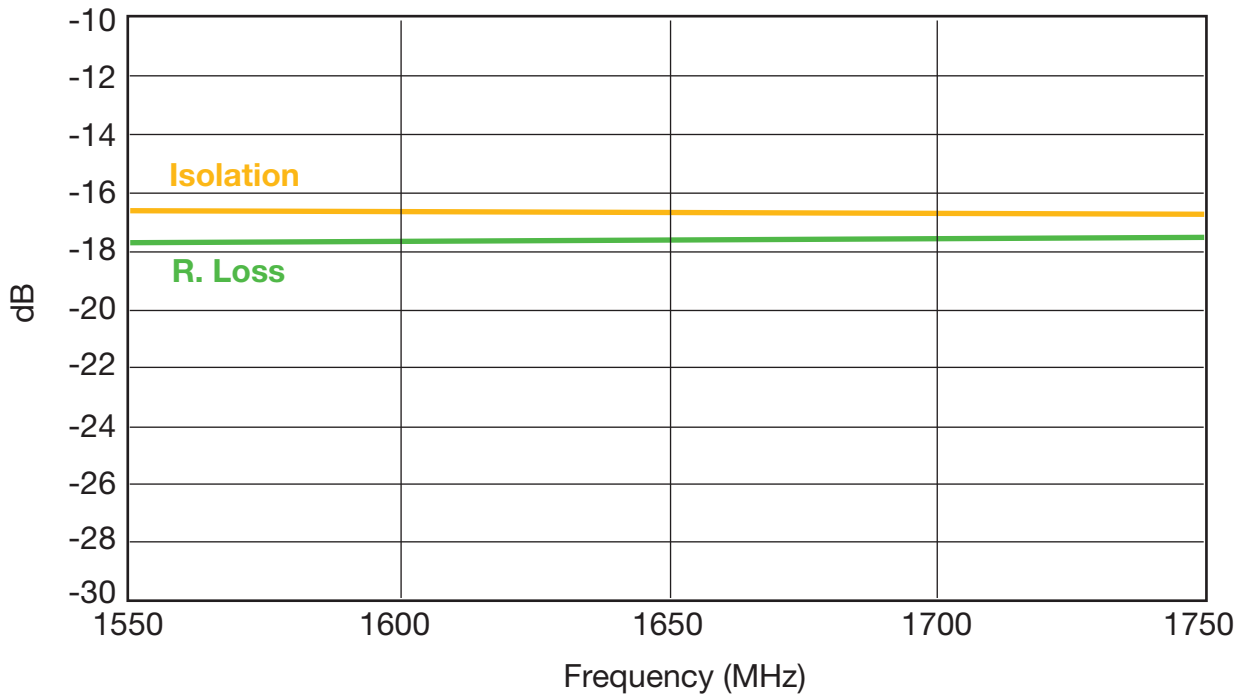

Thin-Film Directional Couplers

DB0805 3dB 90° Couplers



1800 ± 50MHz DB0805A1800AWTR

3

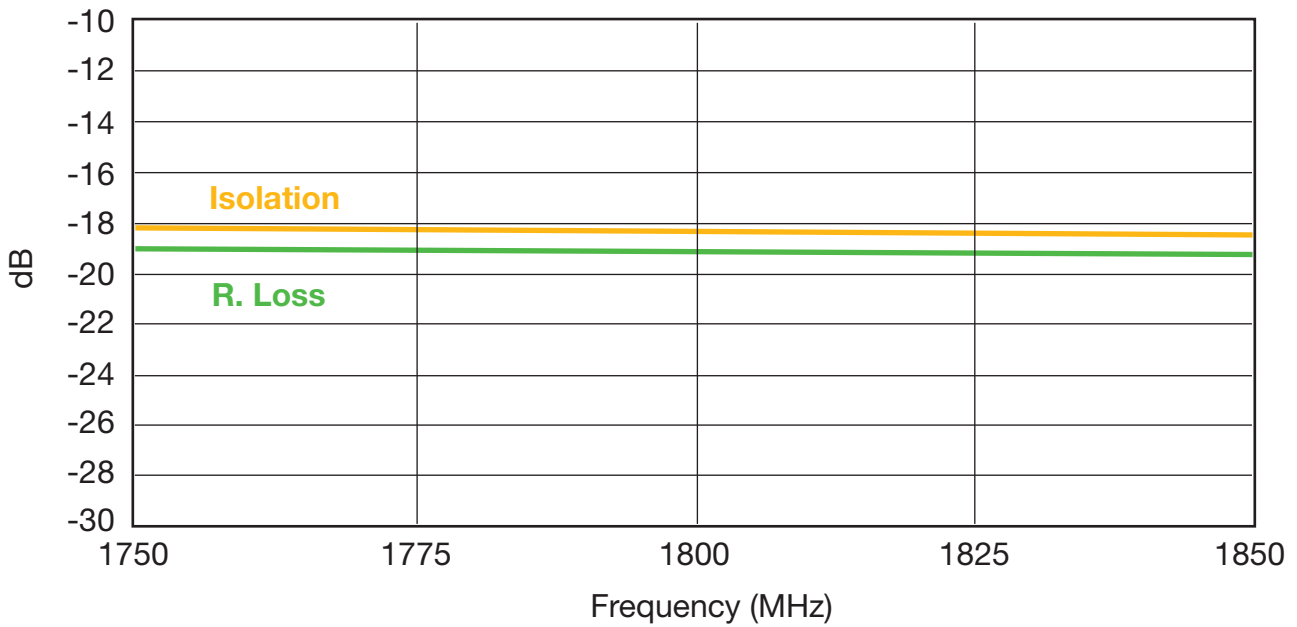
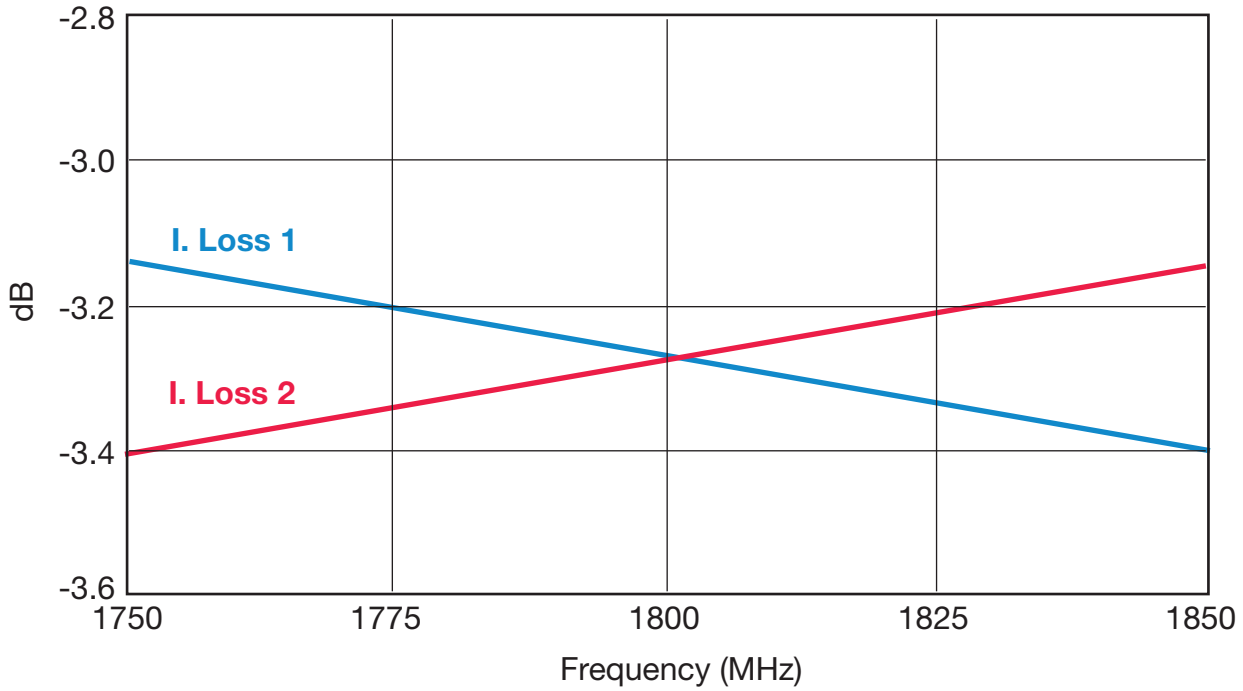

Thin-Film Directional Couplers

DB0805 3dB 90° Couplers



1850 ± 50MHz DB0805A1850AWTR

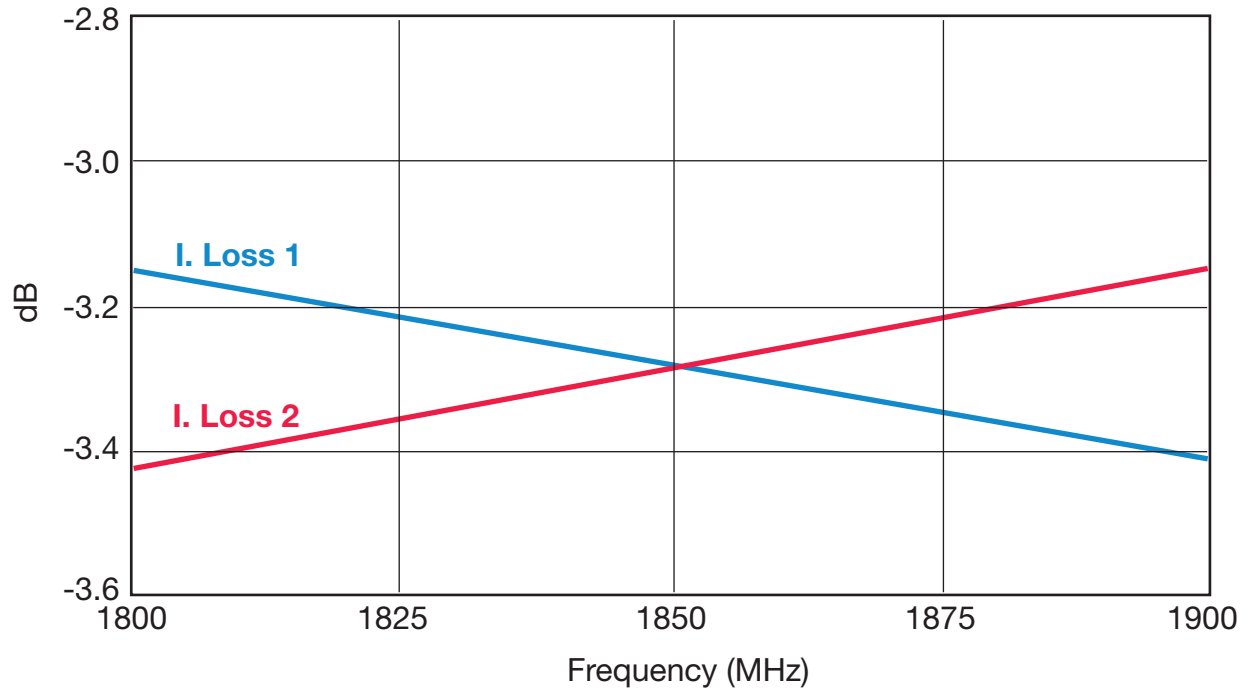

3

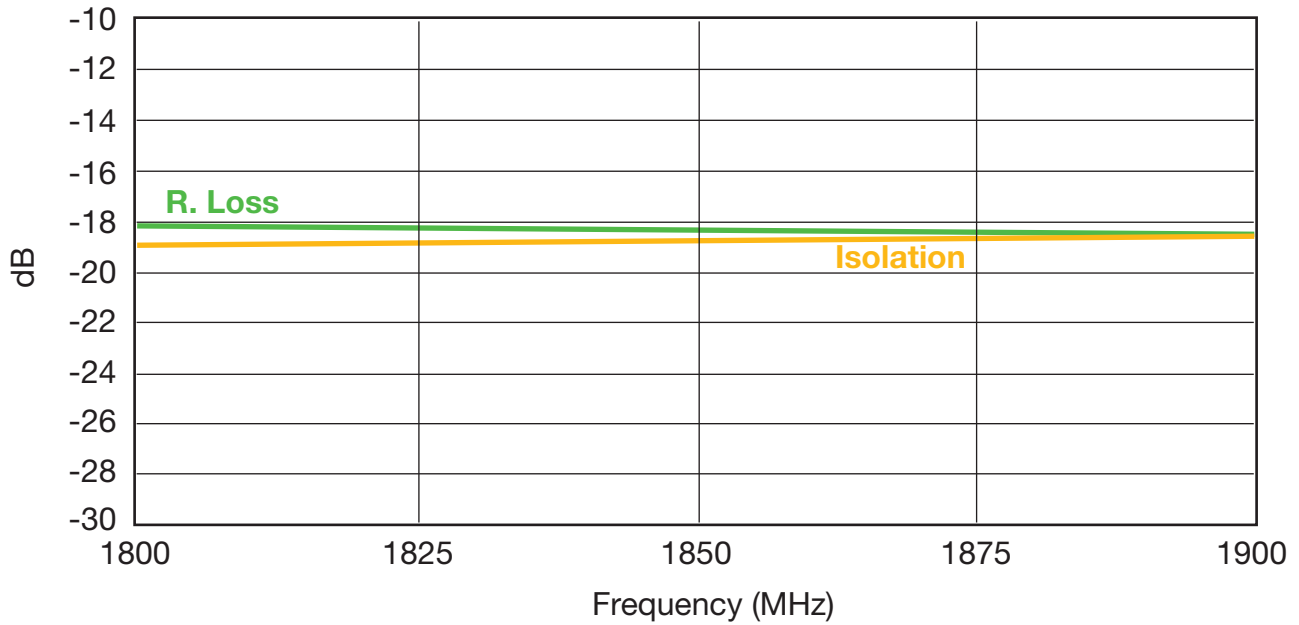

Thin-Film Directional Couplers

DB0805 3dB 90° Couplers



1900 ± 50MHz DB0805A1900AWTR

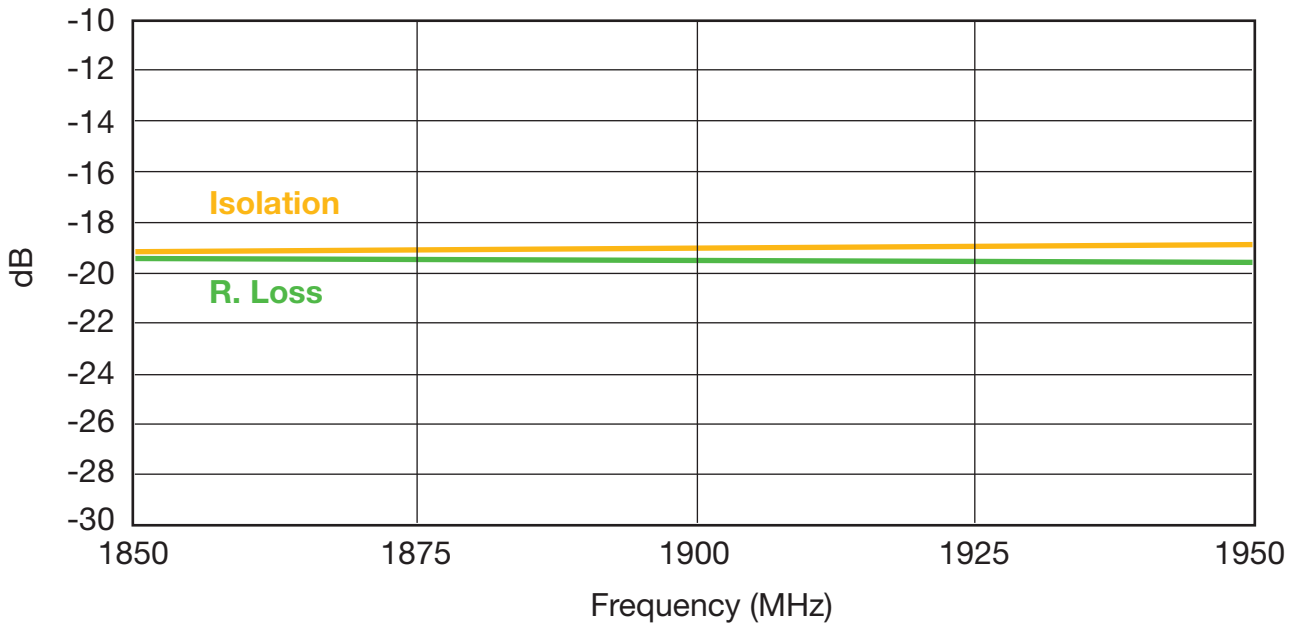
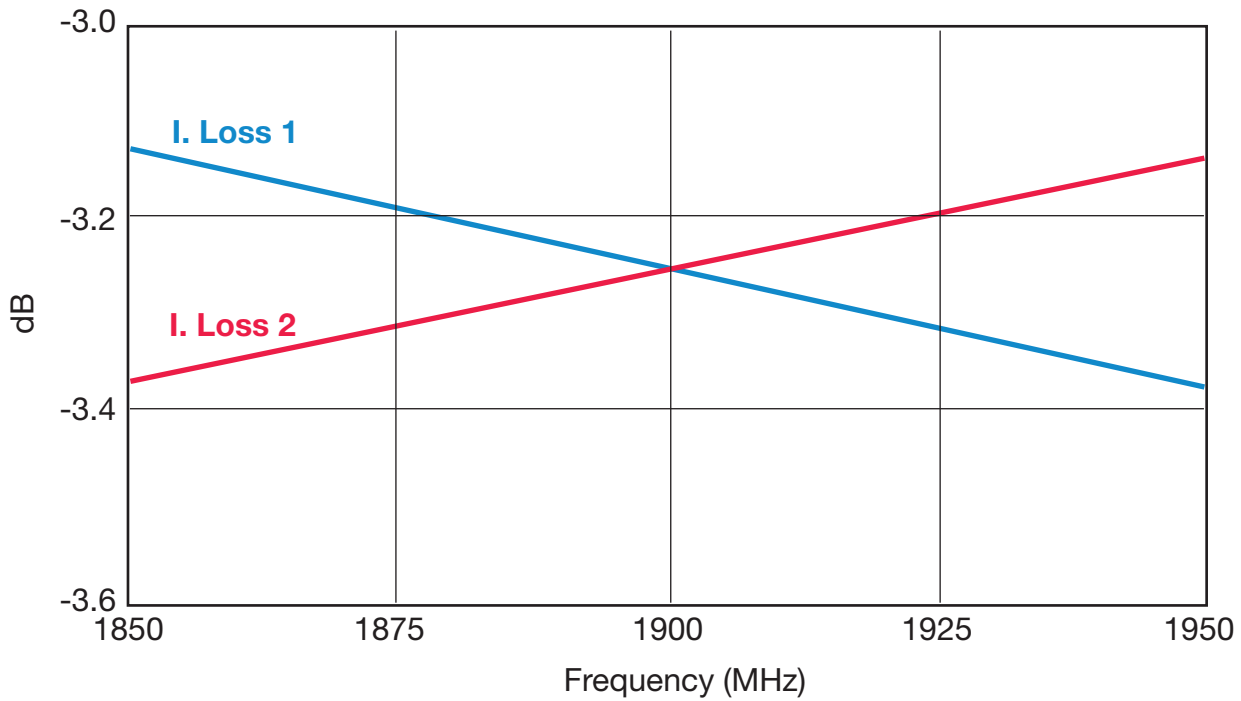

3

Thin-Film Directional Couplers

DB0805 3dB 90° Couplers



1950 ± 50MHz DB0805A1950AWTR

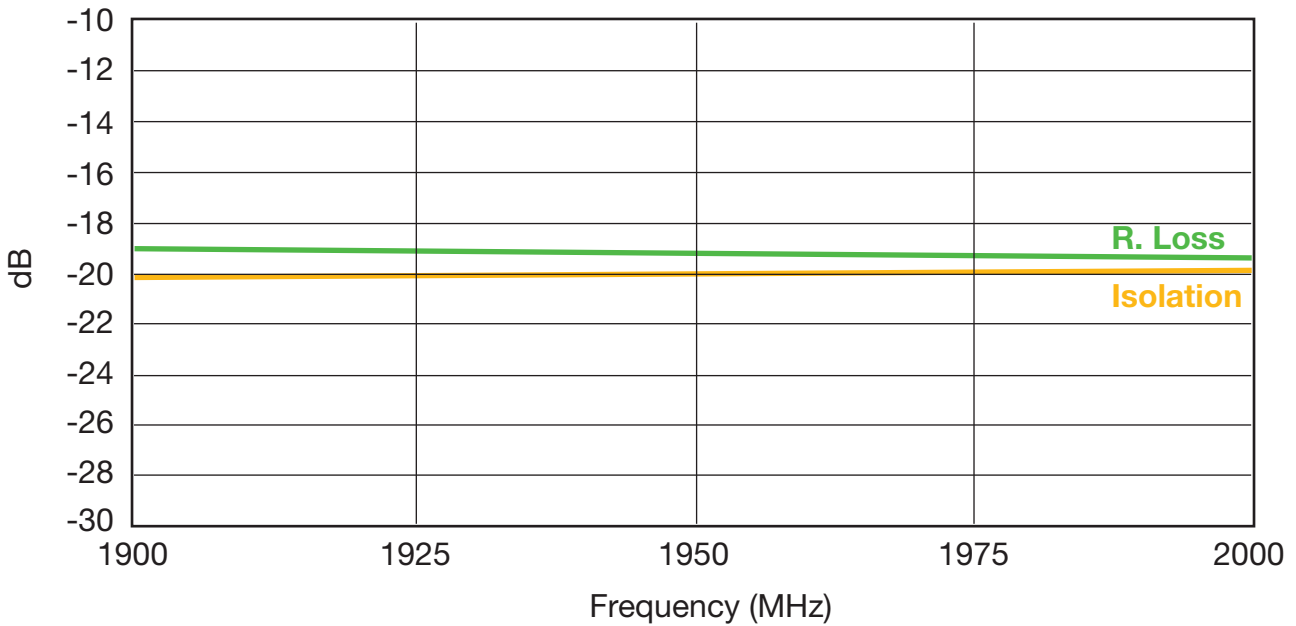
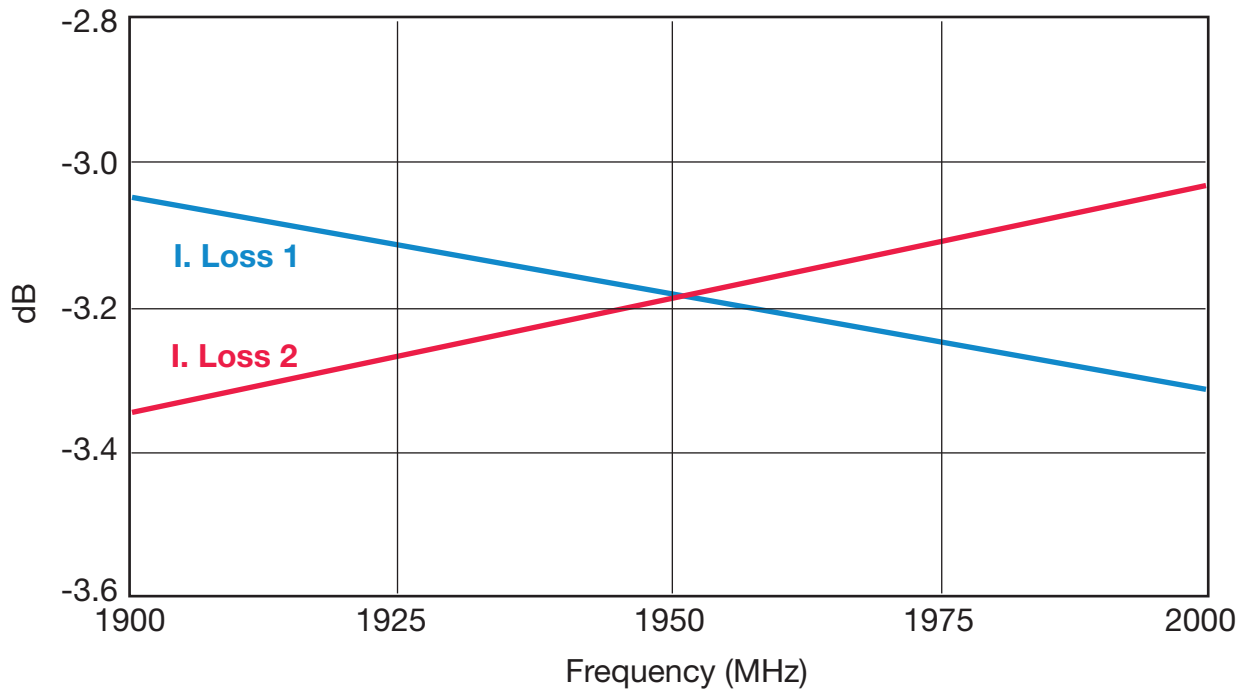

3

Thin-Film Directional Couplers

DB0805 3dB 90° Couplers



2140 ± 50MHz DB0805A2140AWTR

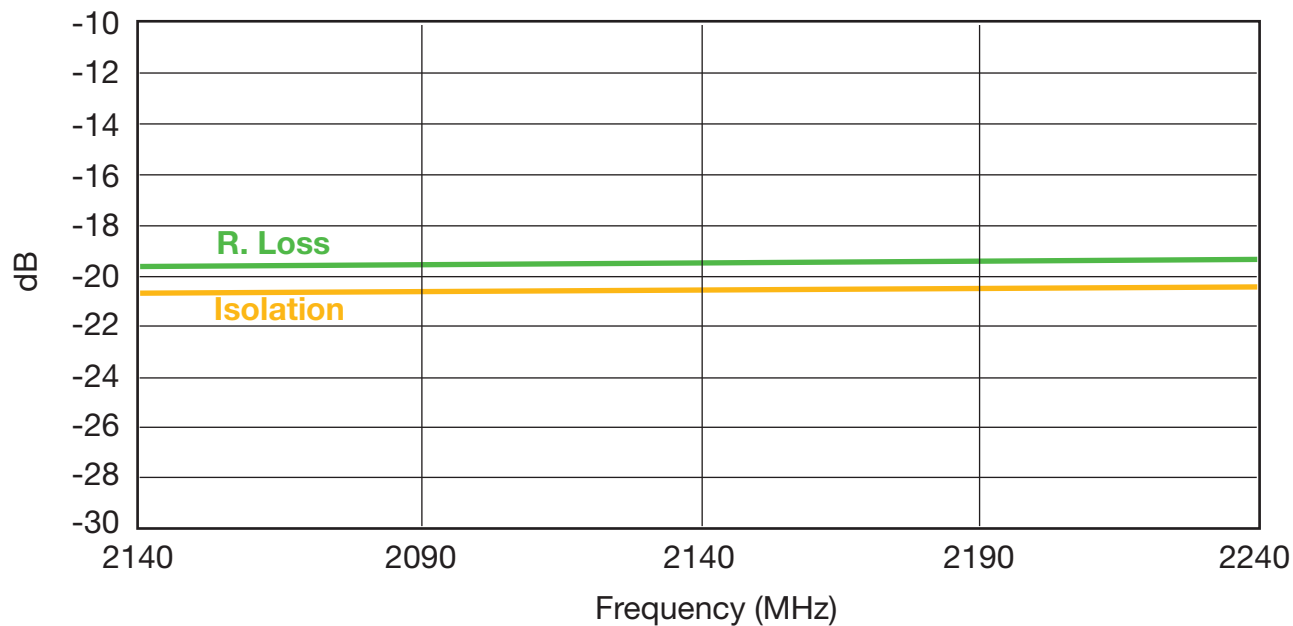
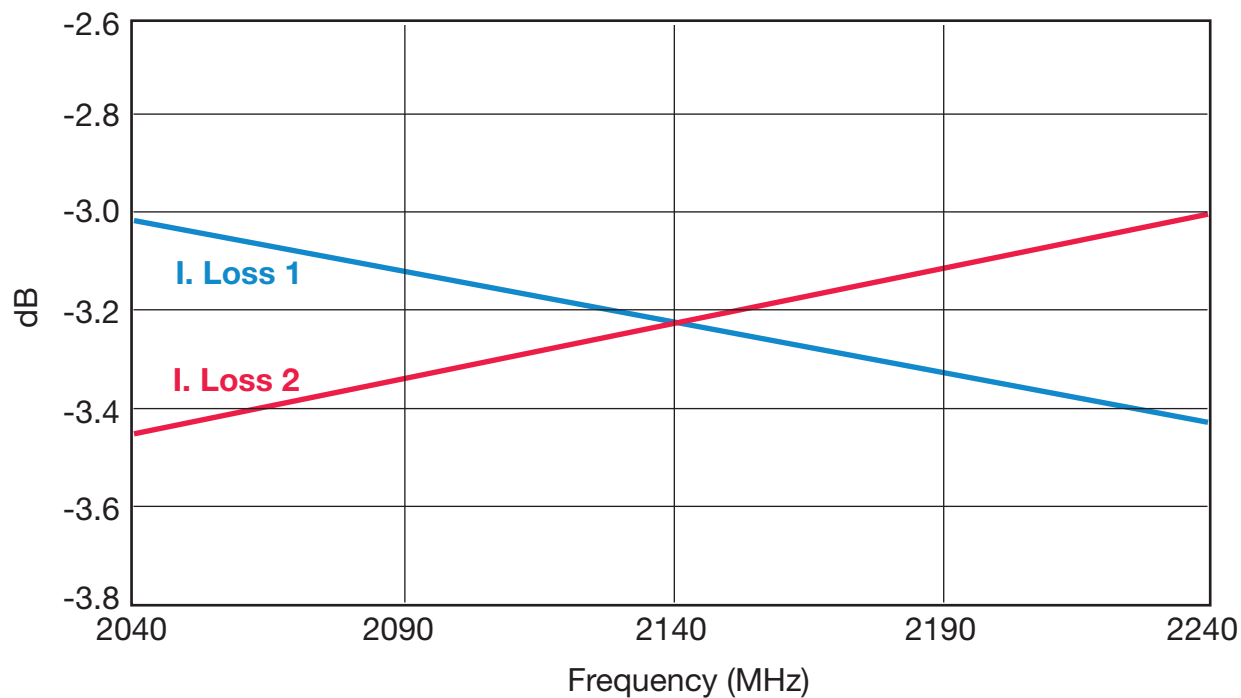

3

Thin-Film Directional Couplers

DB0805 3dB 90° Couplers



2325 ± 50MHz DB0805A2325AWTR

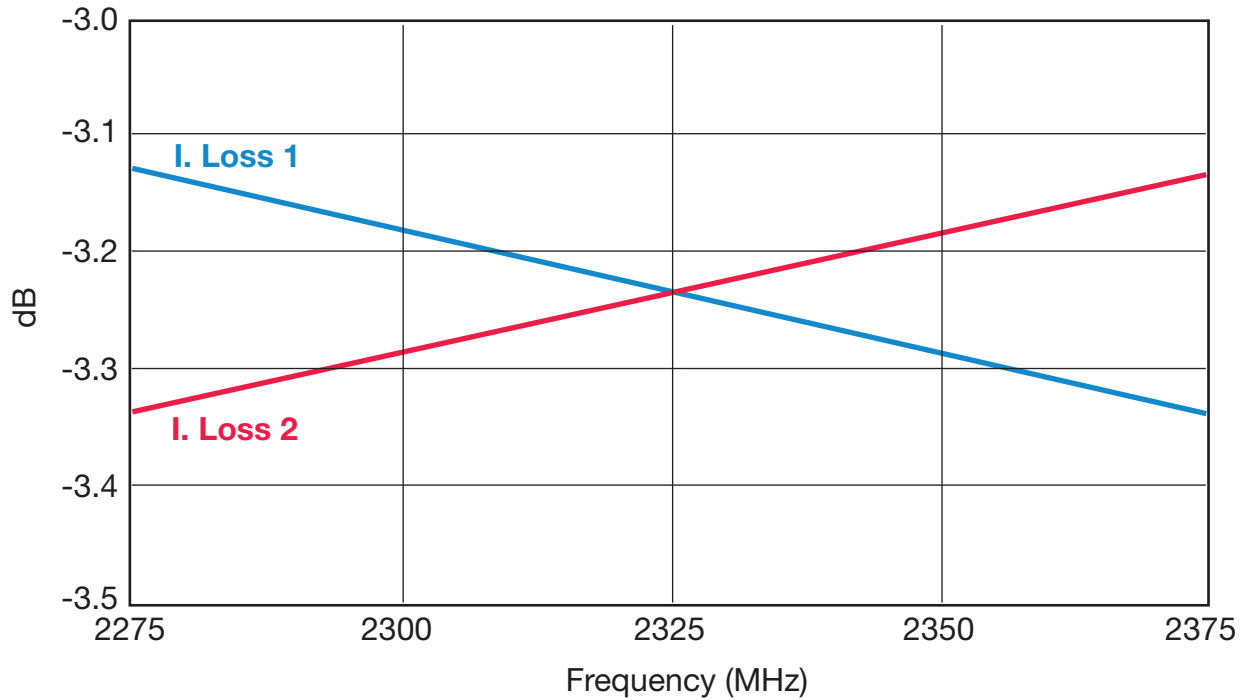

3

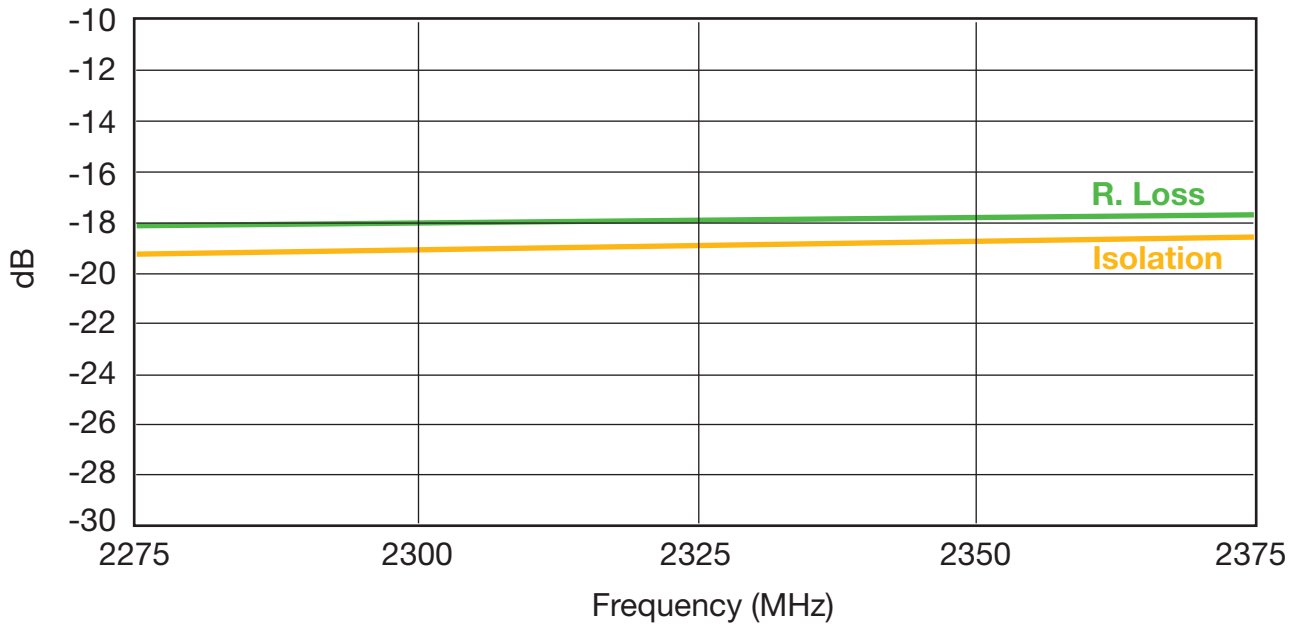

DB0805 3dB 90° Test Jigs

GENERAL DESCRIPTION

These jigs are designed for testing the DB0805 3dB 90° Couplers using a Vector Network Analyzer.

They consist of a dielectric substrate, having 50Ω microstrips as conducting lines and a bottom ground plane located at a distance of 0.254mm from the microstrips.

The substrate used is Neltec's NH9338ST0254C1BC.

The connectors are SMA type (female), 'Johnson Components Inc.' Product P/N: 142-0701-841.

Both a measurement jig and a calibration jig are provided.

The calibration jig is designed for a full 2-port calibration, and consists of an open line, short line and through line. LOAD calibration can be done by a 50Ω SMA termination.

MEASUREMENT PROCEDURE

When measuring a component, it can be either soldered or pressed using a non-metallic stick until all four ports touch the appropriate pads. Set the VNA to the relevant frequency band. Connect the VNA using a 10dB attenuator on the jig

terminal connected to port 2. Follow the VNA's instruction manual and use the [calibration jig](#) to perform a full 2-port calibration in the required bandwidths.

3

Place the coupler on the [measurement jig](#) as follows:

- | | |
|-------------------------------------|--|
| Input (Coupler) → Connector 1 (Jig) | Output 1 (Coupler) → Connector 3 (Jig) |
| 50Ω (Coupler) → Connector 2 (Jig) | Output 2 (Coupler) → Connector 4 (Jig) |

To measure **R. Loss** and **I. Loss 1** connect:

- | | |
|----------------------------------|----------------------------------|
| Connector 1 (Jig) → Port 1 (VNA) | Connector 3 (Jig) → Port 2 (VNA) |
| Connector 2 (Jig) → 50Ω | Connector 4 (Jig) → 50Ω |

To measure **R. Loss** and **I. Loss 2** connect:

- | | |
|----------------------------------|----------------------------------|
| Connector 1 (Jig) → Port 1 (VNA) | Connector 3 (Jig) → 50Ω |
| Connector 2 (Jig) → 50Ω | Connector 4 (Jig) → Port 2 (VNA) |

To measure **Isolation** connect:

- | | |
|-------------------------|----------------------------------|
| Connector 1 (Jig) → 50Ω | Connector 3 (Jig) → Port 1 (VNA) |
| Connector 2 (Jig) → 50Ω | Connector 4 (Jig) → Port 2 (VNA) |

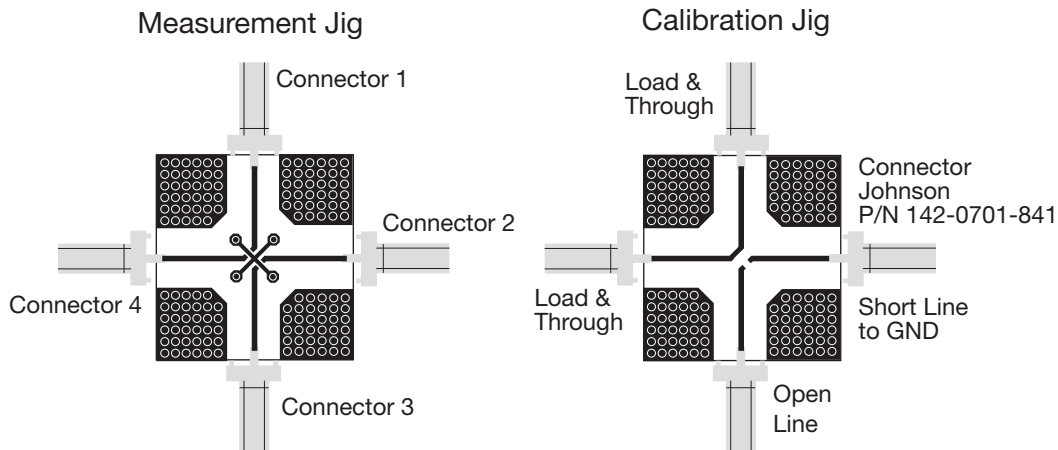



Thin-Film Technology

Integrated Thin-Film
Low-Pass Filters

Thin-Film Low Pass Filter



LP0402N Series Harmonic Lead-Free LGA Termination

RFAP TECHNOLOGY

The LP0402N Series Harmonic Low Pass Filter is based on the proprietary RFAP Thin-Film multilayer technology. The technology provides a miniature part with excellent high frequency performance and rugged construction for reliable automatic assembly.

The RFAP Harmonic Low Pass Filter is offered in a variety of frequency bands compatible with various types of high frequency wireless systems.

APPLICATIONS

- Wireless communications
- Wireless LAN's
- GPS
- WiMAX

LAND GRID ARRAY ADVANTAGES

- Inherent Low Profile
- Self Alignment during Reflow
- Excellent Solderability
- Low Parasitics
- Better Heat Dissipation

HOW TO ORDER

LP
T
Style

0402
T
Size

N
T
Type

XXXX
T
Frequency
MHz

X
T
Sub-Type

N
T
Termination
LGA
Lead Free

TR
T
Taped & Reeled

4

QUALITY INSPECTION

Finished parts are 100% tested for electrical parameters and visual characteristics. Each production lot is evaluated on a sample basis for:

- Static Humidity: 85°C, 85% RH, 160 hours
- Endurance: 125°C, IR, 4 hours

TERMINATION

Nickel/Lead-Free solder coating compatible with automatic soldering technologies: reflow, wave soldering, vapor phase and manual.

Thin-Film Low Pass Filter



LP0402N Series Harmonic Lead-Free LGA Termination

DIMENSIONS: millimeters (inches) (Bottom View)

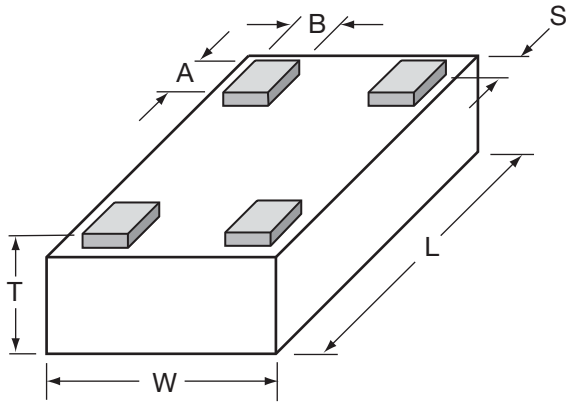

L	1.0±0.05 (0.040±0.002)	A	0.20±0.06 (0.008±0.002)
W	0.58±0.04 (0.023±0.002)	B	0.18±0.05 (0.007±0.002)
T	0.35±0.5 (0.014±0.002)	S	0.05±0.05 (0.002±0.002)

TERMINALS (Top View)

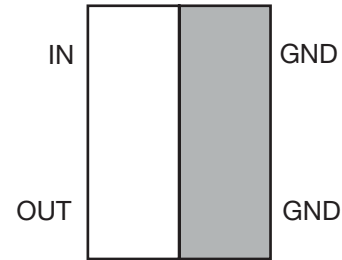

RECOMMENDED PAD LAYOUT (mm)

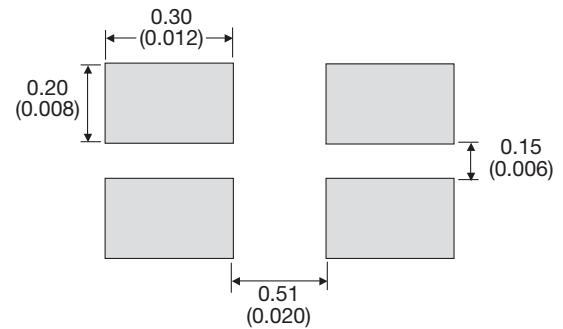

ELECTRICAL CHARACTERISTICS

(Guaranteed over -40°C to $+85^{\circ}\text{C}$ Operating Temperature Range)

P/N	Frequency Band [MHz]	I. Loss [dB]	R. Loss [dB]	Attenuation [dB]
LP0402N3500ANTR	3400-3600	0.3 typ (0.5 max)	19	30 @ $2 \times F_0$ 20 @ $3 \times F_0$
LP0402N5200ANTR	5050-5350	0.2 typ (0.5 max)	19	30 @ $2 \times F_0$ 20 @ $3 \times F_0$

Thin-Film Low Pass Filter



LP0402N Series Harmonic Lead-Free LGA Termination Test Jig

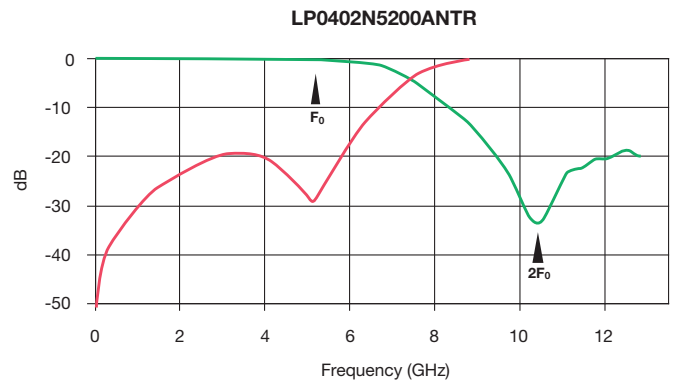
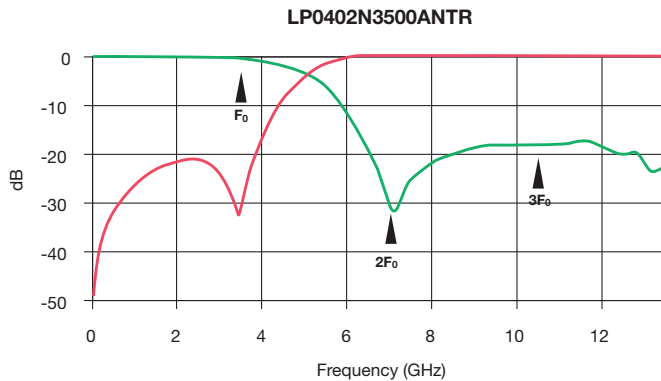

TEST JIG FOR LP0402 LOW PASS FILTER

GENERAL DESCRIPTION

These jigs are designed for testing the LP0603 LGA Low Pass Filters using a Vector Network Analyzer.

They consist of a dielectric substrate, having 50Ω microstrips as conducting lines and a bottom ground plane located at a distance of 0.127mm from the microstrips.

The substrate used is Neltec's NH9338ST0127C1BC (or similar).

The connectors are SMA type (female), 'Johnson Components Inc.' Product P/N: 142-0701-841 (or similar).

Both a measurement jig and a calibration jig are provided.

The calibration jig is designed for a full 2-port calibration, and consists of an open line, short line and through line. LOAD calibration can be done by a 50Ω SMA termination.

MEASUREMENT PROCEDURE

Follow the VNA's instruction manual and use the [calibration jig](#) to perform a full 2-Port calibration in the required bandwidths.

Solder the filter to the [measurement jig](#) as follows:

- | | | | |
|-----------------|---------------------|--------------|-------------|
| Input (Filter) | ➔ Connector 1 (Jig) | GND (Filter) | ➔ GND (Jig) |
| Output (Filter) | ➔ Connector 2 (Jig) | GND (Filter) | ➔ GND (Jig) |

Set the VNA to the relevant frequency band. Connect the VNA using a 10dB attenuator on the jig terminal connected to port 2 (using an RF cable).

4

Measurement

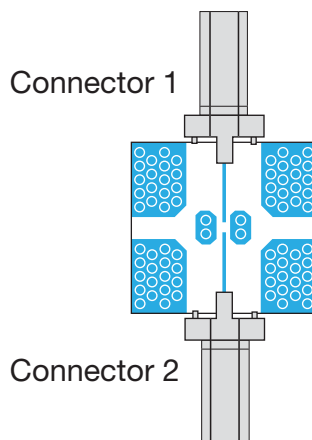

Calibration Jig

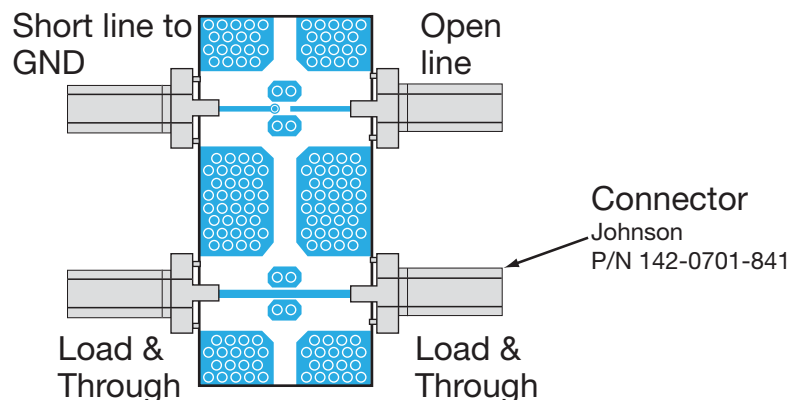

Thin-Film Low Pass Filter



LP0603 Lead-Free LGA Type

GENERAL DESCRIPTION

The LP0603 ITF (Integrated Thin Film) Lead-Free LGA Low Pass Filter is based on thin-film multilayer technology. The technology provides a miniature part with excellent high frequency performance and rugged construction for reliable automatic assembly.

The ITF Low Pass Filters are offered in a variety of frequency bands compatible with various types of high frequency wireless systems.

FEATURES

- Miniature Size: 0603
- Frequency Range: 900MHz -2.4GHz
- Characteristic Impedance: 50 Ohm
- Operating/Storage Temperature: -40°C to +85°C
- Power Rating: 3W Continuous
- Low Profile
- Rugged Construction
- Lead Free
- Taped and Reeled

APPLICATIONS

- Mobile communications
- Satellite TV receivers
- GPS
- Vehicle location systems
- Wireless LANs
- RFID

LAND GRID ARRAY ADVANTAGES

- Inherent Low Profile
- Self Alignment during Reflow
- Excellent Solderability
- Low Parasitics
- Better Heat Dissipation

HOW TO ORDER

LP
T
Style

0603
T
Size
0603

A
T
Type
A or N

XXXX
T
Frequency
MHz

A
T
Sub-Type

N
T
Termination
LGA
**Ni/Lead Free Solder

**RoHS Compliant

TR
T
Taped & Reeled

FINAL QUALITY INSPECTION

Finished parts are 100% tested for electrical parameters and visual characteristics. Each production lot is evaluated on a sample basis for:

- Static Humidity: 85°C, 85% RH, 160 hours
- Endurance: 125°C, IR, 4 hours

TERMINATION

Nickel/Lead-Free Solder coating compatible with automatic soldering technologies: reflow, wave soldering, vapor phase and manual.



Please select correct termination style

Thin-Film Low Pass Filter



LP0603 Lead-Free LGA Type

DIMENSIONS: millimeters (inches) (Bottom View)

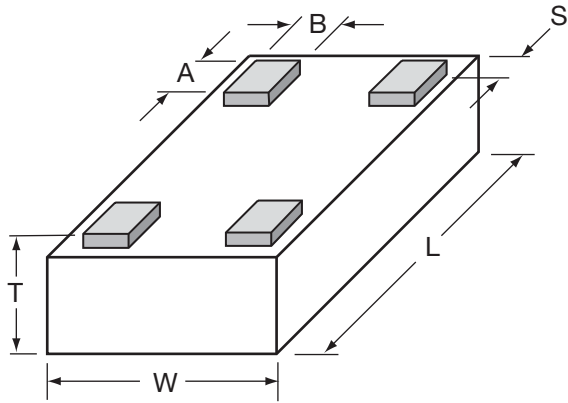

L	1.6±0.1 (0.063±0.004)	A	0.25±0.05 (0.010±0.002)
W	0.84±0.1 (0.033±0.004)	B	0.20±0.05 (0.008±0.002)
T	0.60±0.1 (0.024±0.004)	S	0.05±0.05 (0.002±0.002)

TERMINALS AND ORIENTATION IN TAPE (Top View)

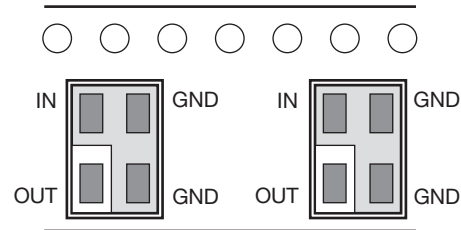

RECOMMENDED PAD LAYOUT (mm)

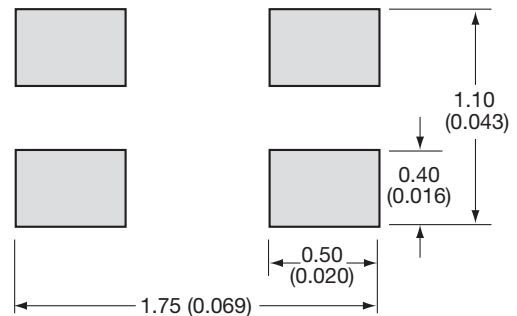

4

ELECTRICAL CHARACTERISTICS

(Guaranteed over -40°C to +85°C Operating Temperature Range)

P/N	Frequency Band [MHz]	I. Loss [dB]	VSWR max [dB]	Attenuation typ. [dB]
LP0603A0902ANTR	890-915	0.35 typ (0.5 max)	1.4	25 @ 2xF ₀ 14 @ 3xF ₀
LP0603A0947ANTR	935-960	0.35 typ (0.5 max)	1.4	25 @ 2xF ₀ 17 @ 3xF ₀
LP0603A1747ANTR	1710-1785	0.3 typ (0.5 max)	1.4	25 @ 2xF ₀ 17 @ 3xF ₀
LP0603A1842ANTR	1805-1880	0.3 typ (0.5 max)	1.4	27 @ 2xF ₀ 15 @ 3xF ₀
LP0603A1880ANTR	1840-1920	0.3 typ (0.5 max)	1.4	25 @ 2xF ₀ 17 @ 3xF ₀
LP0603A1950ANTR	1920-1980	0.3 typ (0.5 max)	1.4	27 @ 2xF ₀ 15 @ 3xF ₀
LP0603A2140ANTR	2110-2170	0.3 typ (0.5 max)	1.4	27 @ 2xF ₀ 17 @ 3xF ₀
LP0603A2442ANTR	2412-2472	0.3 typ (0.5 max)	1.4	25 @ 2xF ₀ 17 @ 3xF ₀
LP0603N3500ANTR	3400-3600	-0.3 typ. -0.5 max.	1.4	30 @ 2xF ₀ 20 @ 3xF ₀
LP0603N5200ANTR	5050-5350	-0.2 typ. -0.5 max.	1.4	30 @ 2xF ₀ 20 @ 3xF ₀
LP0603N5500ANTR	5350-5650	-0.2 typ. -0.5 max.	1.4	30 @ 2xF ₀ 20 @ 3xF ₀

Note: additional frequencies available upon request

Thin-Film Low Pass Filter

LP0603 Lead-Free LGA Type Test Jig

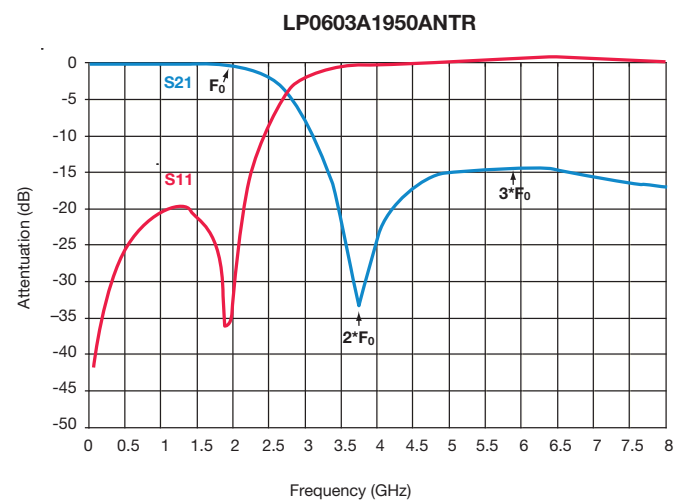
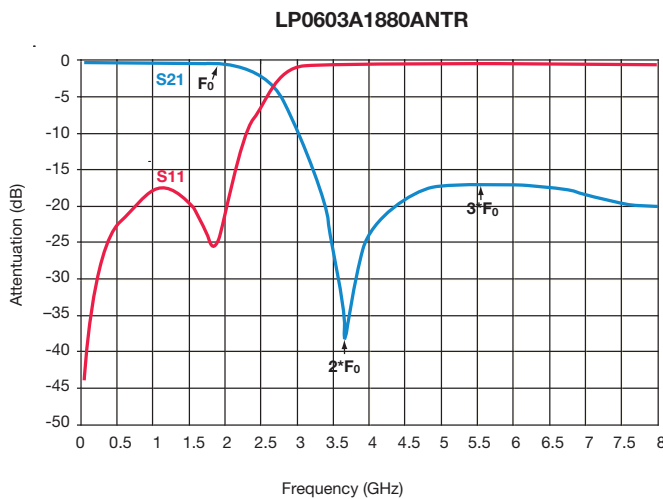
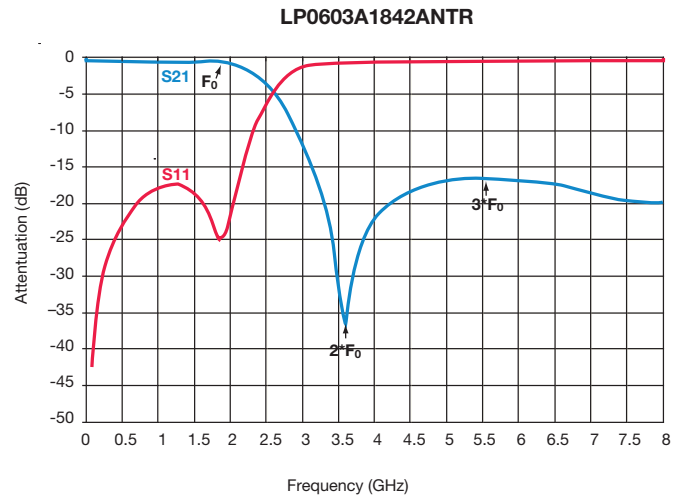
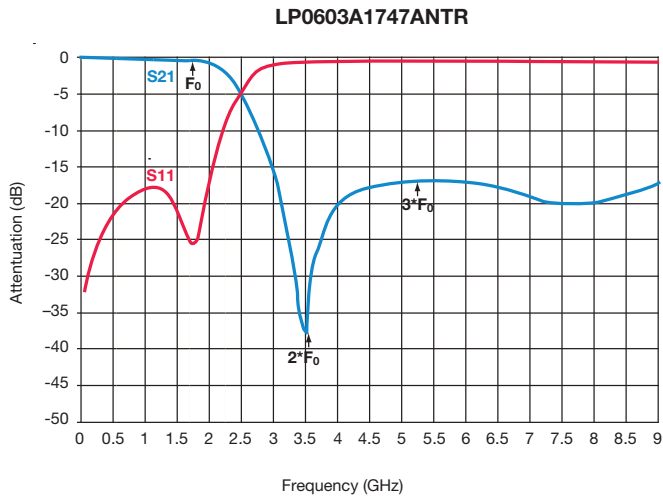
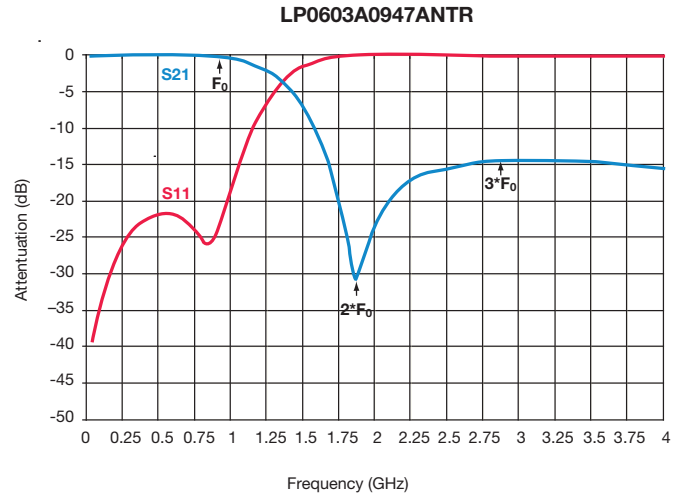
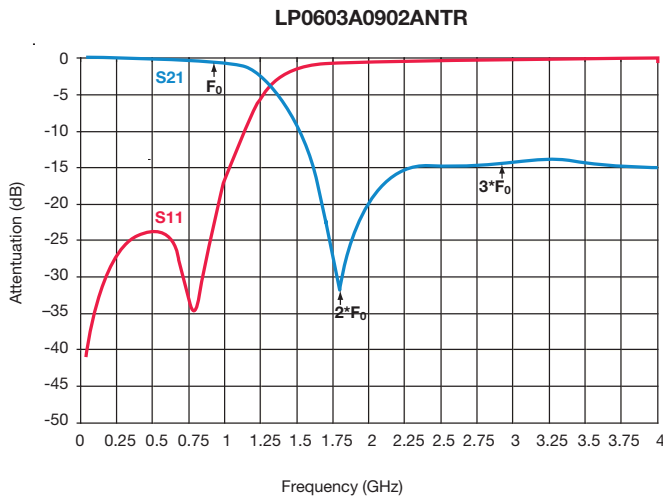

4

Thin-Film Low Pass Filter

LP0603 Lead-Free LGA Type Test Jig

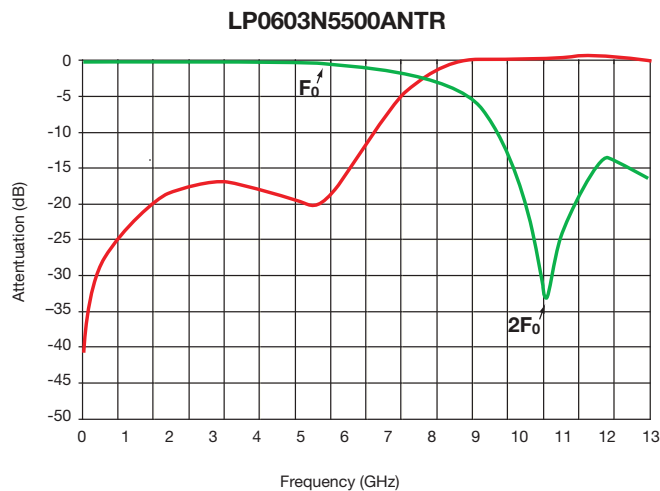
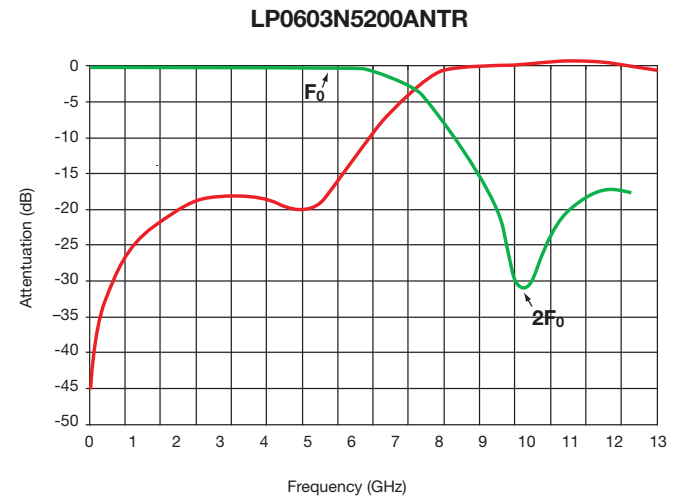
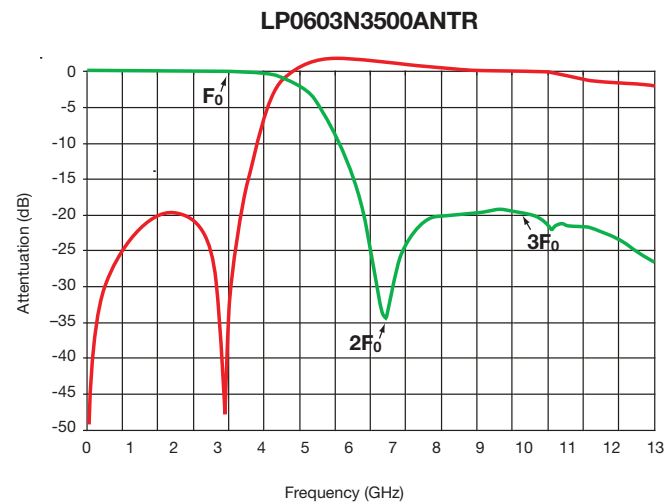
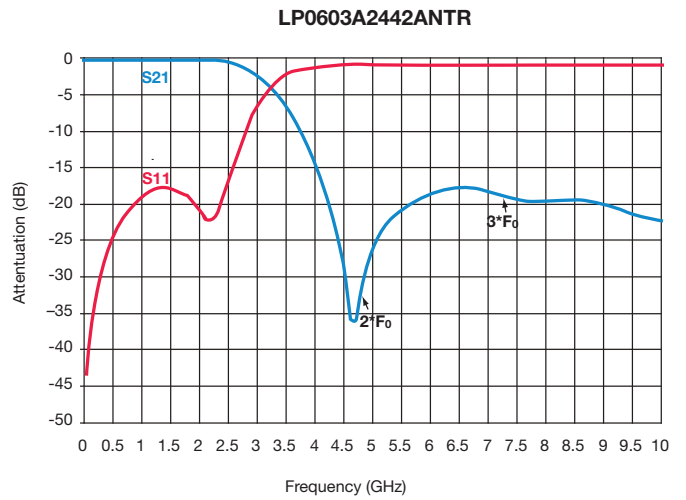
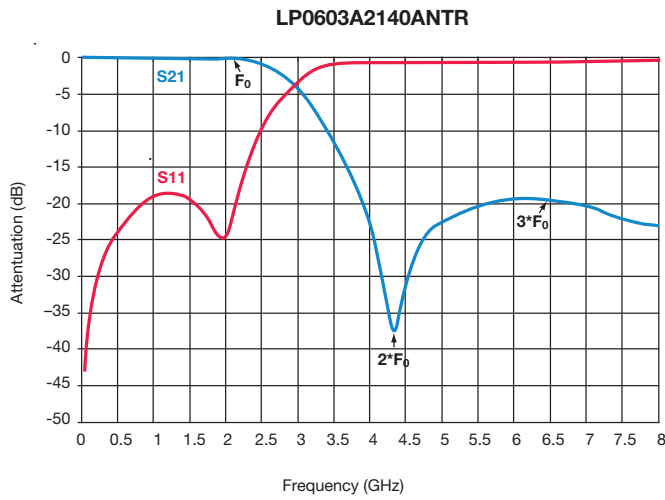

4

Thin-Film Low Pass Filter

LP0603 Lead-Free LGA Type Test Jig

TEST JIG FOR LP0603 LEAD-FREE LGA LOW PASS FILTER

GENERAL DESCRIPTION

These jigs are designed for testing the LP0603 LGA Low Pass Filters using a Vector Network Analyzer.

They consist of a dielectric substrate, having 50Ω microstrips as conducting lines and a bottom ground plane located at a distance of 0.127mm from the microstrips.

The substrate used is Neltec's NH9338ST0127C1BC (or similar).

The connectors are SMA type (female), 'Johnson Components Inc.' Product P/N: 142-0701-841 (or similar).

Both a measurement jig and a calibration jig are provided.

The calibration jig is designed for a full 2-port calibration, and consists of an open line, short line and through line. LOAD calibration can be done by a 50Ω SMA termination.

MEASUREMENT PROCEDURE

Follow the VNA's instruction manual and use the [calibration jig](#) to perform a full 2-Port calibration in the required bandwidths.

Solder the filter to the [measurement jig](#) as follows:

- | | | | |
|-----------------|---------------------|--------------|-------------|
| Input (Filter) | ➔ Connector 1 (Jig) | GND (Filter) | ➔ GND (Jig) |
| Output (Filter) | ➔ Connector 2 (Jig) | GND (Filter) | ➔ GND (Jig) |

Set the VNA to the relevant frequency band. Connect the VNA using a 10dB attenuator on the jig terminal connected to port 2 (using an RF cable).

Measurement

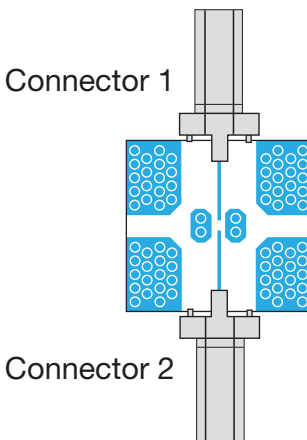

Calibration Jig

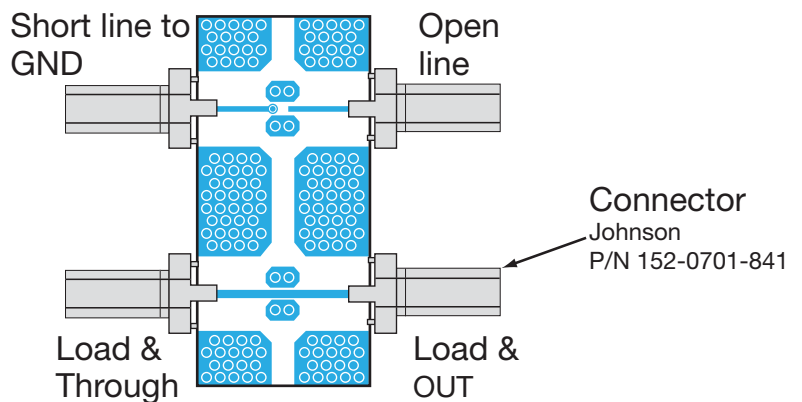

Thin-Film Low Pass Filter



LP0805 Type Harmonic

GENERAL DESCRIPTION

The ITF (Integrated Thin-Film) SMD Filter is based on thin-film multilayer technology. The technology provides a miniature part with excellent high frequency performance and rugged construction for reliable automatic assembly.

The ITF Filter is offered in a variety of frequency bands compatible with various types of high frequency wireless systems.

FEATURES

- Small Size: 0805
- Frequency Range: 800MHz - 3.5GHz
- Characteristic Impedance: 50Ω
- Operating / Storage Temp.: -40°C to +85°C
- Power Rating: 3W Continuous
- Low Profile
- Rugged Construction
- Taped and Reeled

APPLICATIONS

- Mobile Communications
- Satellite TV Receivers
- GPS
- Vehicle Location Systems
- Wireless LAN's

DIMENSIONS: millimeters (inches)

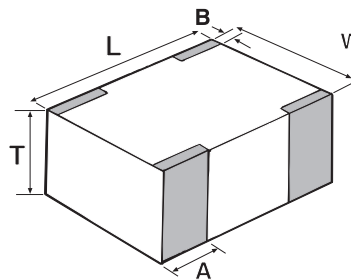

L	2.03±0.1 (0.080±0.004)
W	1.55±0.1 (0.061±0.004)
T	1.02±0.1 (0.040±0.004)
A	0.56±0.25 (0.022±0.010)
B	0.35±0.15 (0.014±0.006)

FINAL QUALITY INSPECTION

Finished parts are 100% tested for electrical parameters and visual/mechanical characteristics. Each production lot is evaluated on a sample basis for:

- Static Humidity: 85°C, 85% RH, 160 hours
- Endurance: 125°C, I_R 4 hours

TERMINATION

Nickel/Solder coating (Sn, Pb) compatible with automatic soldering technologies: reflow, wave soldering, vapor phase and manual.

4

HOW TO ORDER

LP
T
Style
Low Pass

0805A
T
Size
0805

0902
T
Frequency
MHz

AW
T
Termination
AW= Nickel/Solder (SnPb)
**AS = Nickel/ Lead Free
Solder (Sn100)

TR
T
Packaging Code
TR = Tape and Reel

**RoHS Compliant



Please select correct termination style

TERMINALS AND LAYOUT (Top View)

Orientation in Tape

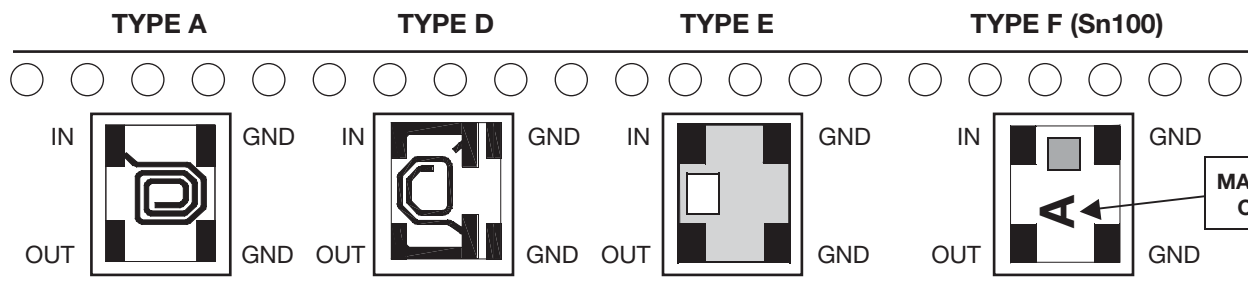

MARKING CODE

Thin-Film Low Pass Filter



LP0805 Type Harmonic

ELECTRICAL CHARACTERISTICS

Application	Part Number	Frequency Band (MHz)	I. Loss max	VSWR max	Attenuation (dB) Typical	Layout Type (SnPb)	Layout Type F Marking Code
E-GSM	LP0805A0897AW	880 - 915	0.4dB (0.3dB typ)	1.7	30 @ 2X F_0 20 @ 3X F_0	A	E
	LP0805A0942AW	925 - 960				A	F
GSM	LP0805A0902AW	890 - 915				A	E
	LP0805A0947AW	935 - 960				A	F
	LP0805A1119AW	1101 - 1137				A	H
AMPS	LP0805A0836AW	824 - 849				A	A
	LP0805A0881AW	869 - 894				A	C
PCN	LP0805A1747AW	1710 - 1785				D	I
	LP0805A1842AW	1805 - 1880				D	J
PCS	LP0805A1880AW	1850 - 1910				D	K
	LP0805A1960AW	1930 - 1990				D	M
PHP	LP0805A1907AW	1895 - 1920				D	L
DECT	LP0805A1890AW	1880 - 1900				D	K
3G	LP0805A2150AW	1905 - 2180				D	N
Wireless LAN	LP0805A2442AW	2400 - 2484				D	S
WLL	LP0805A3500AW	3400 ~ 3600				E	X

Typical Electrical Performance

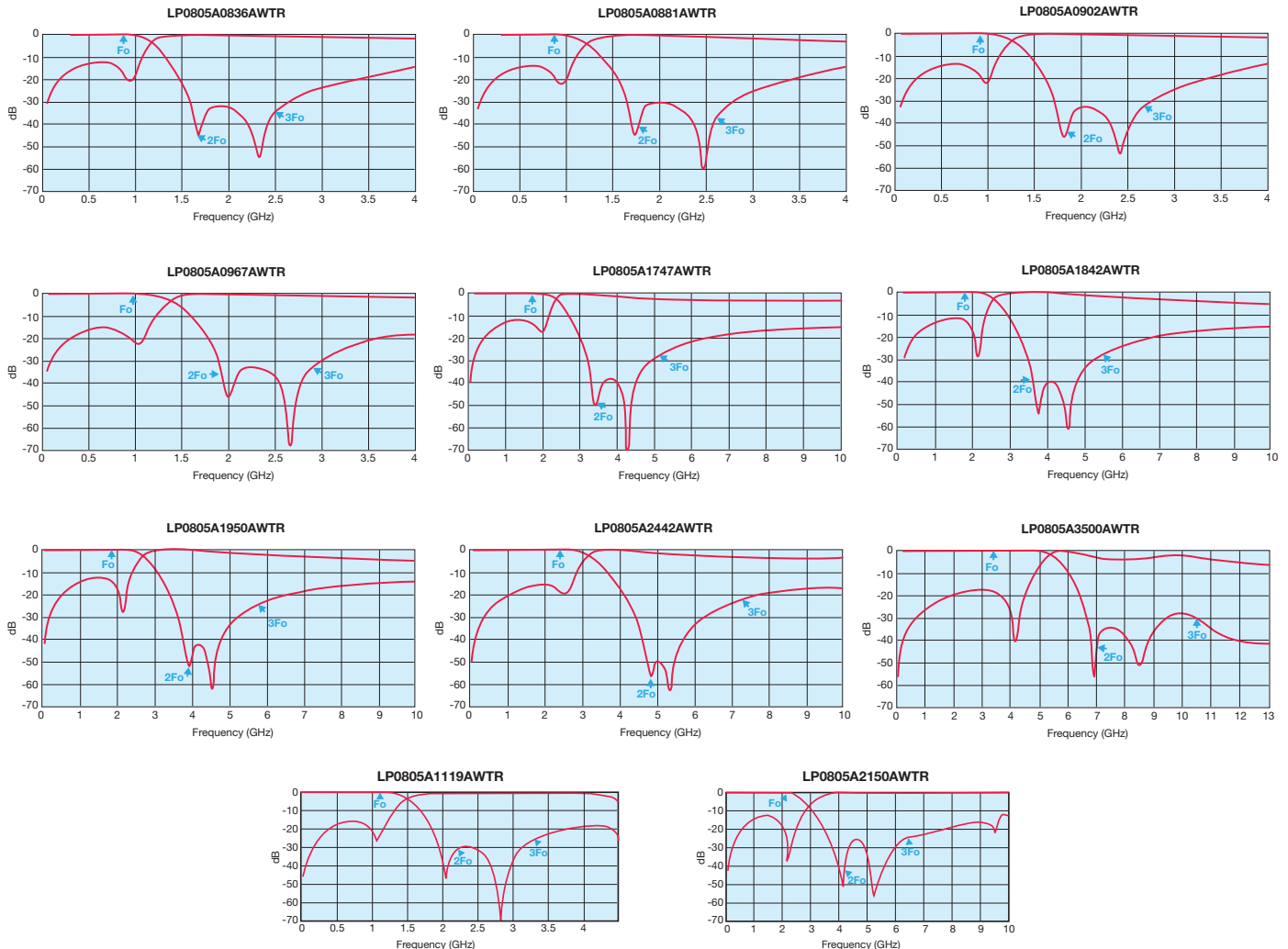

4

LP0805 Test Jig

ITF TEST JIG FOR LOW PASS FILTER 0805

GENERAL DESCRIPTION

These jigs are designed for testing the LPF0805 Low Pass Filters using a Vector Network Analyzer.

They consist of a dielectric substrate, having 50W microstrips as conducting lines and a bottom ground plane located at a distance of 0.254 mm from the microstrips.

The substrate used is RF-35-0100-C1B107 (or similar).

The connectors are SMA type (female), 'Johnson Components Inc.' Product P/N: 142-0701-841(or similar).

Both a measurement jig and a calibration jig are provided.

The calibration jig is designed for a full 2-port calibration, and consists of an open line, short line and through line. LOAD calibration can be done by a 50W SMA termination.

MEASUREMENT PROCEDURE

Follow the VNA's instruction manual and use the [calibration jig](#) to perform a full 2-Port calibration in the required bandwidths.

Solder the filter to the [measurement jig](#) as follows:

Input (Filter) ➔ Connector 1 (Jig) GND (Filter) ➔ GND (Jig)

Output (Filter) ➔ Connector 2 (Jig) GND (Filter) ➔ GND (Jig)

Set the VNA to the relevant frequency band. Connect the VNA using a 10dB attenuator on the jig terminal connected to port 2 (using an RF cable).

Measurement

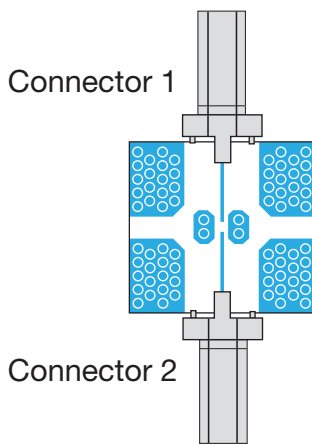

Calibration Jig

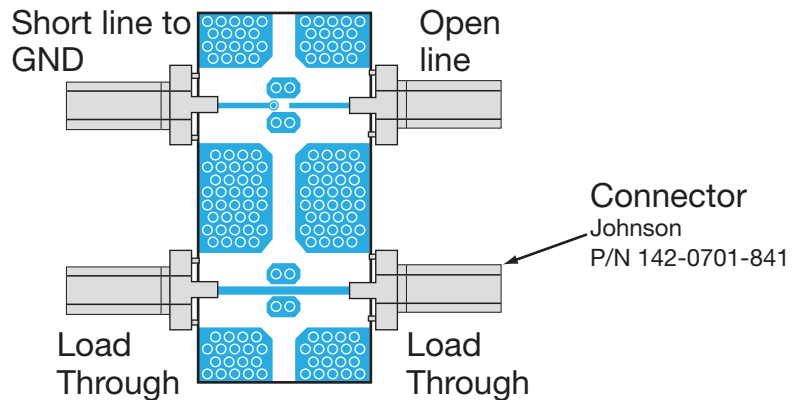



Thin-Film Products Designer Kits

Accu-P[®]/Accu-L[®] Kits

RF/Microwave Thin-Film Products



Designer Kits *(Special Kits Available Upon Request)*

Accu-P®
Designer Kit Type 1700
Order Number: Accu-P® 0201KIT02

Volts	Capacitors Value pF	Tolerance
25	0.1	A
	0.2	A
	0.3	A
	0.4	B
	0.5	B
	0.6	B
	0.7	B
	0.8	B
	0.9	B
	1.0	B
	1.1	B
	1.2	B
	1.3	B
	1.5	B
1.8	B	
16	2.0	B
	2.2	B
	2.4	B
	2.7	B
10	3.0	B
	3.3	B
	3.6	B
	3.9	B
	4.7	B
10	5.6	B
	6.8	B
	7.5	B
	8.2	B
	10.0	G
12.0	G	

600 Capacitors, 20 each of 30 values
Tolerance A = ± 0.05pF
 B = ± 0.1pF
 G = ± 2%

Accu-P®
Designer Kit Type 1800
Order Number: Accu-P® 0201KIT03

Volts	Capacitors Value pF	Tolerance
25	1.0	A
	1.1	A
	1.2	A
	1.3	A
	1.4	A
	1.5	A
	1.6	A
	1.7	A
	1.8	A
	1.9	A
	2.0	A
	2.1	B
	2.2	B
	2.3	B
16	2.4	B
	2.5	B
	2.6	B
	2.7	B
	2.8	B
10	2.9	B
	3.0	B
	3.1	B
	3.3	B
	3.4	B
10	3.6	B
	3.9	B
	4.1	B
	4.3	B
	4.5	B
4.7	B	

600 Capacitors, 20 each of 30 values
Tolerance A = ± 0.05pF
 B = ± 0.1pF

Accu-P®
Designer Kit Type 1300
Order Number: Accu-P® 0402KIT01

Volts	Capacitors Value pF	Tolerance
25	0.1	A
	0.2	A
	0.3	A
	0.4	B
	0.5	B
	0.6	B
	0.7	B
	0.8	B
	0.9	B
	1.0	B
	1.1	B
	1.2	B
	1.5	B
	1.8	B
16	2.0	B
	2.2	B
	2.4	B
	2.7	B
	3.0	B
10	3.3	B
	3.9	B
	4.7	B
	5.6	B
	6.8	B
16	8.2	B
	10.0	G
10	12.0	G
	15.0	G
	18.0	G
	22.0	G

600 Capacitors, 20 each of 30 values
Tolerance A = ± 0.05pF
 B = ± 0.1pF
 G = ± 2%

Accu-P®
Designer Kit Type 1400
Order Number: Accu-P® 0402KIT02

Volts	Capacitors Value pF	Tolerance
25	1.0	A
	1.1	A
	1.2	A
	1.3	A
	1.4	A
	1.5	A
	1.6	A
	1.7	A
	1.8	A
	1.9	A
	2.0	A
	2.1	B
	2.2	B
	2.3	B
	2.4	B
	2.5	B
	2.6	B
	2.7	B
	2.8	B
	2.9	B
25	3.0	B
	3.1	B
	3.3	B
	3.4	B
	3.6	B
	3.9	B
	4.1	B
	4.3	B
25	4.5	B
	4.7	B

600 Capacitors, 20 each of 30 values
Tolerance A = ± 0.05pF
 B = ± 0.1pF

Accu-P®
Designer Kit Type 900
Order Number: Accu-P® 0603KIT01

Volts	Capacitors Value pF	Tolerance
50	0.1	A
	0.2	A
	0.3	A
	0.4	B
	0.5	B
	0.6	B
	0.7	B
	0.8	B
	0.9	B
	1.0	B
	1.1	B
	1.2	B
	1.5	B
	1.8	B
25	2.0	B
	2.2	B
	2.4	B
	2.7	B
	3.0	B
	3.3	B
	3.9	B
	4.7	B
	5.6	B
	6.8	B
25	8.2	B
	10.0	G
	12.0	G
	15.0	G
25	18.0	G
	22.0	G

600 Capacitors, 20 each of 30 values
Tolerance A = ± 0.05pF
 B = ± 0.1pF
 G = ± 2%

Accu-P®
Designer Kit Type 800
Order Number: Accu-P® 0805KIT02

Volts	Capacitors Value pF	Tolerance
100	0.1	A
	0.2	A
	0.3	A
	0.4	A
	0.5	B
	0.7	B
	0.8	B
	0.9	B
	1.0	B
	1.2	B
	1.5	B
	1.8	B
	2.0	B
	2.2	B
50	2.7	B
	3.3	B
	3.9	B
	4.7	B
	5.6	B
	6.8	B
	8.2	B
	10.0	G
50	12.0	G
	15.0	G
	18.0	G
	22.0	G
25	27.0	J
	33.0	J
	39.0	J
	47.0	J

300 Capacitors, 10 each of 30 values
Tolerance A = ± 0.05pF G = ± 2%
 B = ± 0.1pF J = ± 5%



RF/Microwave Thin-Film Products



Designer Kits *(Special Kits Available Upon Request)*

Accu-P®
Designer Kit Type 700
Order Number: Accu-P® 1210KIT02

Volts	Capacitors Value pF	Tolerance
100	1.0	B
	1.5	B
	1.8	B
	2.2	B
	2.7	B
	3.3	B
	4.7	B
	5.6	B
	6.8	B
	10.0	G
	12.0	G
	18.0	G
	22.0	G
	27.0	G
	33.0	G

150 Capacitors, 10 each of 15 values
Tolerance B = ± 0.1pF
 G = ± 2%

Accu-P®
Designer Kit Type 2100
Order Number: Accu-P® 0402KIT03

Volts	Capacitors Value pF	Tolerance
25	0.05	P
	0.10	P
	0.15	P
	0.20	P
	0.25	P
	0.30	P
	0.35	P
	0.40	P
	0.45	P
	0.50	P
	0.55	P
	0.60	P
	0.65	P
	0.70	P
	0.75	P

300 Capacitors, 20 each of 15 values
Tolerance P = ± 0.02pF

Accu-P®
Designer Kit Type 2200
Order Number: Accu-P® 0603KIT02

Volts	Capacitors Value pF	Tolerance
50	0.05	P
	0.10	P
	0.15	P
	0.20	P
	0.25	P
	0.30	P
	0.35	P
	0.40	P
	0.45	P
	0.50	P
	0.55	P
	0.60	P
	0.65	P
	0.70	P
	0.75	P

300 Capacitors, 20 each of 15 values
Tolerance P = ± 0.02pF

Accu-P®
Designer Kit Type 2000
Order Number: Accu-P® 0201KIT04

Volts	Capacitors Value pF	Tolerance
25	0.05	P
	0.10	P
	0.15	P
	0.20	P
	0.25	P
	0.30	P
	0.35	P
	0.40	P
	0.45	P
	0.50	P
	0.55	P
	0.60	P
	0.65	P
	0.70	P
	0.75	P

300 Capacitors, 20 each of 15 values
Tolerance P = ± 0.02pF

Accu-L®
Designer Kit Type 1600
Order Number: Accu-L® 0603KIT02

Inductance Value (nH)	Tolerance
1.2	C
1.5	C
1.8	C
2.2	C
2.7	C
3.3	C
3.9	C
4.7	C
5.6	C
6.8	C
8.2	C
10	G
12	G
15	G

280 Inductors, 20 each of 14 values
Tolerance C = ±0.2nH
 G = ±2%

Accu-L®
Designer Kit Type 1100
Order Number: Accu-L® 0805KIT02

Inductance Value (nH)	Tolerance
1.8	C
2.2	C
2.7	C
3.3	C
3.9	C
4.7	C
5.6	C
6.8	D
8.2	D
10.0	J
12.0	J
15.0	J
18.0	J
22.0	J

280 Inductors, 20 each of 14 values
Tolerance C = ±0.2nH
 D = ±0.5nH
 J = ±5%

Accu-L®
Designer Kit Type 2500
Order Number: Accu-L® L0402KIT01

P/N	nH	Tolerance
L0402R82AHN	0.82	±0.05 nH
L04021R0AHN	1.0	±0.05 nH
L04021R2AHN	1.2	±0.05 nH
L04021R5AHN	1.5	±0.05 nH
L04021R8AHN	1.8	±0.05 nH
L04022R2AHN	2.2	±0.05 nH
L04022R7AHN	2.7	±0.05 nH
L04023R3BHN	3.3	±0.1 nH
L04023R9BHN	3.9	±0.1 nH
L04024R7BHN	4.7	±0.1 nH
L04025R6BHN	5.6	±0.1 nH
L04026R8BHN	6.8	±0.1 nH

20 each of 12 values



AVX RF

**RF/Microwave
MLC's**

UQ Series

SQ Series

AQ Series

CDR Series

Porcelain and Ceramic

RF/Microwave

Multilayer Capacitors

High Voltage RF Power Capacitors

6

Microwave MLC's



UQ Series High Q Ultra Low ESR MLC

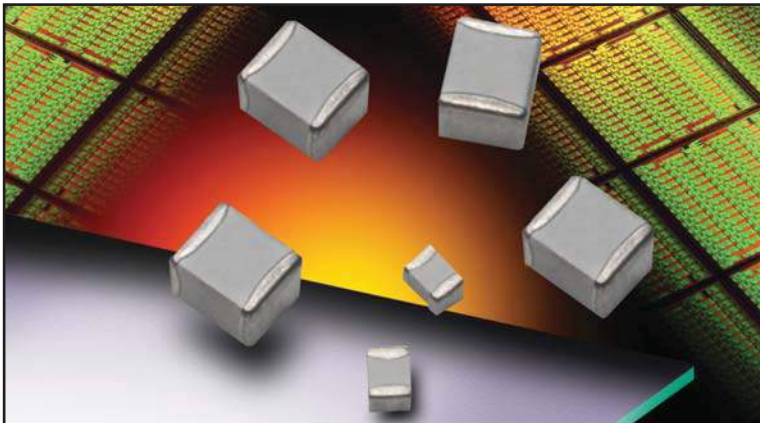

FEATURES:

- Ultra Low ESR
- High Q
- High Self Resonance
- Capacitance Range 0.1 pF to 1000 pF

APPLICATIONS:

- RF Power Amplifiers
- Low Noise Amplifiers
- Filter Networks
- MRI Systems

HOW TO ORDER

UQ <hr/> AVX Style	CB <hr/> Case Size CA = 0605 CB = 1210 CR = 0709 See mechanical dimensions below	7 <hr/> Voltage Code 5 = 50V 1 = 100V E = 150V 2 = 200V V = 250V 9 = 300V 7 = 500V	A <hr/> Temperature Coefficient Code A = 0±30ppm/°C	100 <hr/> Capacitance EIA Capacitance Code in pF. First two digits = significant figures or "R" for decimal place. Third digit = number of zeros or after "R" significant figures.	J <hr/> Capacitance Tolerance Code B = ±.1 pF C = ±.25 pF D = ±.5 pF F = ±1% G = ±2% J = ±5% K = ±10% M = ±20%	A <hr/> Failure Rate Code A = Not Applicable	T <hr/> Termination Style Code J = Nickel Barrier Sn/Pb (60/40) **T = 100% Tin C = Non-Magnetic Barrier/Tin **RoHS Compliant	ME <hr/> Packaging Code ME = 7" Reel Marked * Vertical T&R available * 500 piece reels available
-------------------------------------	---	--	---	--	---	--	---	--

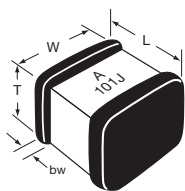

MECHANICAL DIMENSIONS: inches (millimeters)

Case	Length (L)	Width (W)	Thickness (T)	Band Width (bw)
CA	.055 + .015 - .010 (1.40+ .381 - .254)	.055±.015 (1.40±.381)	.057 (1.45) max.	.010 + .010 - .005 (.254 + .254 - .127)
CB	.110 + .020 - .010 (2.79 + .508 - .254)	.110±.015 (2.79±.381)	.102 (2.59) max.	.015±.010 (.381±.254)
CR	.070 ± .015 (1.78 ± .381)	.090±.010 (2.29±.254)	.115 (2.92) max.	.010 + .010 - .005 (.254 + .254 - .127)

TAPE & REEL: All tape and reel specifications are in compliance with EIA RS481 (equivalent to IEC 286 part 3).

- 8mm carrier
- 7" reel: UQCA = 4000 pc T&R
- UQCB = 1000 pc T&R
- UQCR = 1000 pc T&R



6

ELECTRICAL SPECIFICATIONS

		Temperature Characteristic Code A
Temperature Coefficient (TCC)		(A) 0 ± 30 PPM/°C
Capacitance Range		(A) 0.1 pF to 1000 pF
Operating Temperature		0.1 pF to 1000 pF: from -55°C to +125°C
Quality Factor (Q)	A Dielectric CB Case	Greater than 2,000 at 1 MHz
	A Dielectric CA Case	Greater than 2,000 at 1 MHz
	A Dielectric CR Case	Greater than 2,000 at 1 MHz
Insulation Resistance (IR)		0.1 pF to 1000 pF 10 ⁵ Megohms min. @ 25°C at rated WVDC 10 ⁴ Megohms min. @ 125°C at rated WVDC
Working Voltage (WVDC)		See Capacitance Values table
Dielectric Withstanding Voltage (DWW)		250% of rated WVDC for 5 secs
Aging Effects		None
Piezoelectric Effects		None
Capacitance Drift		\pm (0.02% or 0.02 pF), whichever is greater

ENVIRONMENTAL CHARACTERISTICS

AVX UQ will meet and exceed the requirements of EIA-198, MIL-PRF-55681 and MIL-PRF-123

Thermal Shock	Mil-STD-202, Method 107, Condition A
Moisture Resistance	Mil-STD-202, Method 106
Low Voltage Humidity	Mil-STD-202, Method 103, condition A, with 1.5 VDC applied while subjected to an environment of 85°C with 85% relative humidity for 240 hours
Life Test	Mil-STD-202, Method 108, for 2000 hours at 125°C 200% WVDC
Shock	Mil-STD-202, Method 213, Condition J
Vibration	Mil-STD-202, Method 204, Condition B
Immersion	Mil-STD-202, Method 104, Condition B
Salt Spray	Mil-STD-202, Method 101, Condition B
Solderability	Mil-STD-202, Method 208
Terminal Strength	Mil-STD-202, Method 211
Temperature Cycling	Mil-STD-202, Method 102, Condition C
Barometric Pressure	Mil-STD-202, Method 105, Condition B
Resistance to Solder Heat	Mil-STD-202, Method 210, Condition C

Case Size A

TABLE I: TCC: A (0±30PPM/°C)

Cap. pF	Cap. Tol.	WVDC	Cap. pF	Cap. Tol.	WVDC	Cap. pF	Cap. Tol.	WVDC	Cap. pF	Cap. Tol.	WVDC
0.1	B	250	1.6	B, C, D	250	5.6	B, C, D	250	24	F, G, J, K, M	250
0.2	B	250	1.7	B, C, D	250	6.2	B, C, D	250	27	F, G, J, K, M	250
0.3	B,C	250	1.8	B, C, D	250	6.8	B, C, J, K	250	30	F, G, J, K, M	250
0.4	B,C	250	1.9	B, C, D	250	7.5	B, C, J, K	250	33	F, G, J, K, M	250
0.5	B, C, D	250	2.0	B, C, D	250	8.2	B, C, J, K	250	36	F, G, J, K, M	250
0.6	B, C, D	250	2.2	B, C, D	250	9.1	B, C, J, K	250	39	F, G, J, K, M	250
0.7	B, C, D	250	2.4	B, C, D	250	10	F, G, J, K, M	250	43	F, G, J, K, M	250
0.8	B, C, D	250	2.7	B, C, D	250	11	F, G, J, K, M	250	47	F, G, J, K, M	250
0.9	B, C, D	250	3.0	B, C, D	250	12	F, G, J, K, M	250	51	F, G, J, K, M	250
1.0	B, C, D	250	3.3	B, C, D	250	13	F, G, J, K, M	250	56	F, G, J, K, M	250
1.1	B, C, D	250	3.6	B, C, D	250	15	F, G, J, K, M	250	62	F, G, J, K, M	250
1.2	B, C, D	250	3.9	B, C, D	250	16	F, G, J, K, M	250	68	F, G, J, K, M	250
1.3	B, C, D	250	4.3	B, C, D	250	18	F, G, J, K, M	250	75	F, G, J, K, M	250
1.4	B, C, D	250	4.7	B, C, D	250	20	F, G, J, K, M	250	82	F, G, J, K, M	250
1.5	B, C, D	250	5.1	B, C, D	250	22	F, G, J, K, M	250	91	F, G, J, K, M	250
									100	F, G, J, K, M	250

Case Size B

TABLE II: TCC: A (0±30PPM/°C)

Cap. pF	Cap. Tol.	WVDC	Cap. pF	Cap. Tol.	WVDC	Cap. pF	Cap. Tol.	WVDC	Cap. pF	Cap. Tol.	WVDC
0.1	B	500	3.6	B, C, D	500	39	F, G, J, K, M	500	430	F, G, J, K, M	200
0.2	B	500	3.9	B, C, D	500	43	F, G, J, K, M	500	470	F, G, J, K, M	200
0.3	B,C	500	4.3	B, C, D	500	47	F, G, J, K, M	500	510	F, G, J, K, M	100
0.4	B,C	500	4.7	B, C, D	500	51	F, G, J, K, M	500	560	F, G, J, K, M	100
0.5	B, C, D	500	5.1	B, C, D	500	56	F, G, J, K, M	500	620	F, G, J, K, M	100
0.6	B, C, D	500	5.6	B, C, D	500	62	F, G, J, K, M	500	680	F, G, J, K, M	50
0.7	B, C, D	500	6.2	B, C, D	500	68	F, G, J, K, M	500	750	F, G, J, K, M	50
0.8	B, C, D	500	6.8	B, C, J, K	500	75	F, G, J, K, M	500	820	F, G, J, K, M	50
0.9	B, C, D	500	7.5	B, C, J, K	500	82	F, G, J, K, M	500	910	F, G, J, K, M	50
1.0	B, C, D	500	8.2	B, C, J, K	500	91	F, G, J, K, M	500	1000	F, G, J, K, M	50
1.1	B, C, D	500	9.1	B, C, J, K	500	100	F, G, J, K, M	500			
1.2	B, C, D	500	10	F, G, J, K, M	500	110	F, G, J, K, M	300			
1.3	B, C, D	500	11	F, G, J, K, M	500	120	F, G, J, K, M	300			
1.4	B, C, D	500	12	F, G, J, K, M	500	130	F, G, J, K, M	300			
1.5	B, C, D	500	13	F, G, J, K, M	500	150	F, G, J, K, M	300			
1.6	B, C, D	500	15	F, G, J, K, M	500	160	F, G, J, K, M	300			
1.7	B, C, D	500	16	F, G, J, K, M	500	180	F, G, J, K, M	300			
1.8	B, C, D	500	18	F, G, J, K, M	500	200	F, G, J, K, M	300			
1.9	B, C, D	500	20	F, G, J, K, M	500	220	F, G, J, K, M	200			
2.0	B, C, D	500	22	F, G, J, K, M	500	240	F, G, J, K, M	200			
2.2	B, C, D	500	24	F, G, J, K, M	500	270	F, G, J, K, M	200			
2.4	B, C, D	500	27	F, G, J, K, M	500	300	F, G, J, K, M	200			
2.7	B, C, D	500	30	F, G, J, K, M	500	330	F, G, J, K, M	200			
3.0	B, C, D	500	33	F, G, J, K, M	500	360	F, G, J, K, M	200			
3.3	B, C, D	500	36	F, G, J, K, M	500	390	F, G, J, K, M	200			

Case Size R

TABLE III: TCC: A (0±30PPM/°C)

Cap. pF	Cap. Tol.	WVDC	Cap. pF	Cap. Tol.	WVDC	Cap. pF	Cap. Tol.	WVDC	Cap. pF	Cap. Tol.	WVDC
1.0	B, C, D	500	3.0	B, C, D	500	12	G, J, K, M	500	51	G, J, K, M	500
1.1	B, C, D	500	3.3	B, C, D	500	13	G, J, K, M	500	56	G, J, K, M	500
1.2	B, C, D	500	3.6	B, C, D	500	15	G, J, K, M	500	62	G, J, K, M	500
1.3	B, C, D	500	3.9	B, C, D	500	16	G, J, K, M	500	68	G, J, K, M	500
1.4	B, C, D	500	4.3	B, C, D	500	18	G, J, K, M	500	75	G, J, K, M	500
1.5	B, C, D	500	4.7	B, C, D	500	20	G, J, K, M	500	82	G, J, K, M	500
1.6	B, C, D	500	5.1	B, C, D	500	22	G, J, K, M	500	91	G, J, K, M	500
1.7	B, C, D	500	5.6	G, J, K, M	500	24	G, J, K, M	500	100	G, J, K, M	500
1.8	B, C, D	500	6.2	G, J, K, M	500	27	G, J, K, M	500			
1.9	B, C, D	500	6.8	G, J, K, M	500	30	G, J, K, M	500			
2.0	B, C, D	500	7.5	G, J, K, M	500	33	G, J, K, M	500			
2.1	B, C, D	500	8.2	G, J, K, M	500	36	G, J, K, M	500			
2.2	B, C, D	500	9.1	G, J, K, M	500	39	G, J, K, M	500			
2.4	B, C, D	500	10	G, J, K, M	500	43	G, J, K, M	500			
2.7	B, C, D	500	11	G, J, K, M	500	47	G, J, K, M	500			

UQ CA ESR vs. Frequency

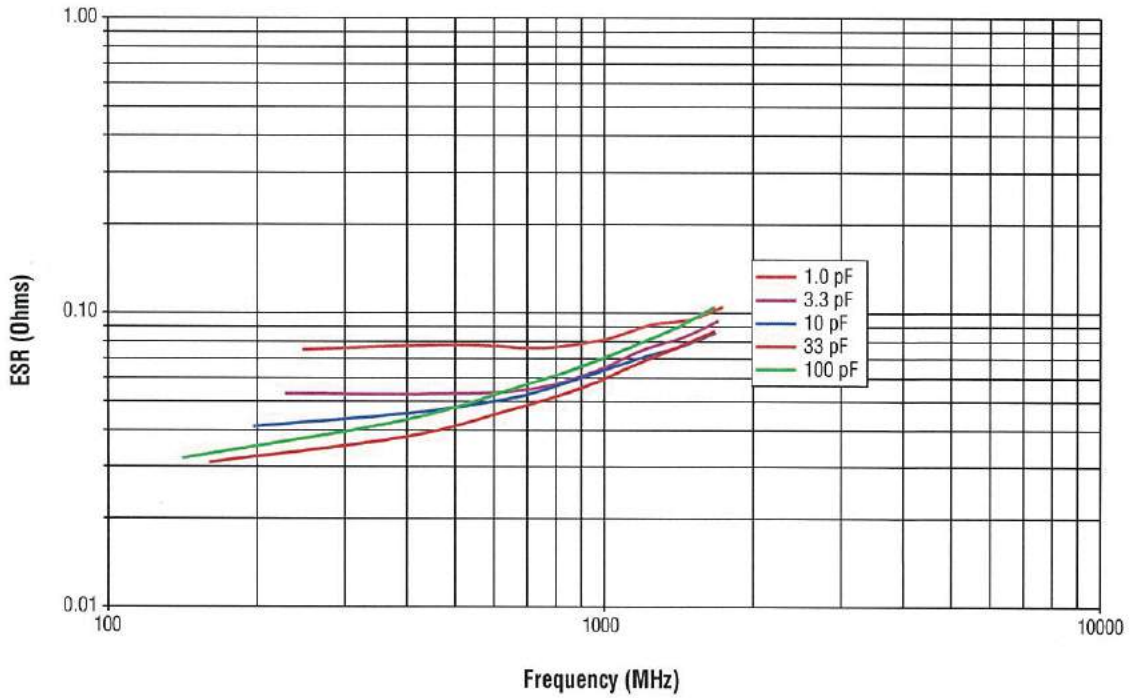

UQ CA FSR & FPR vs. Capacitance

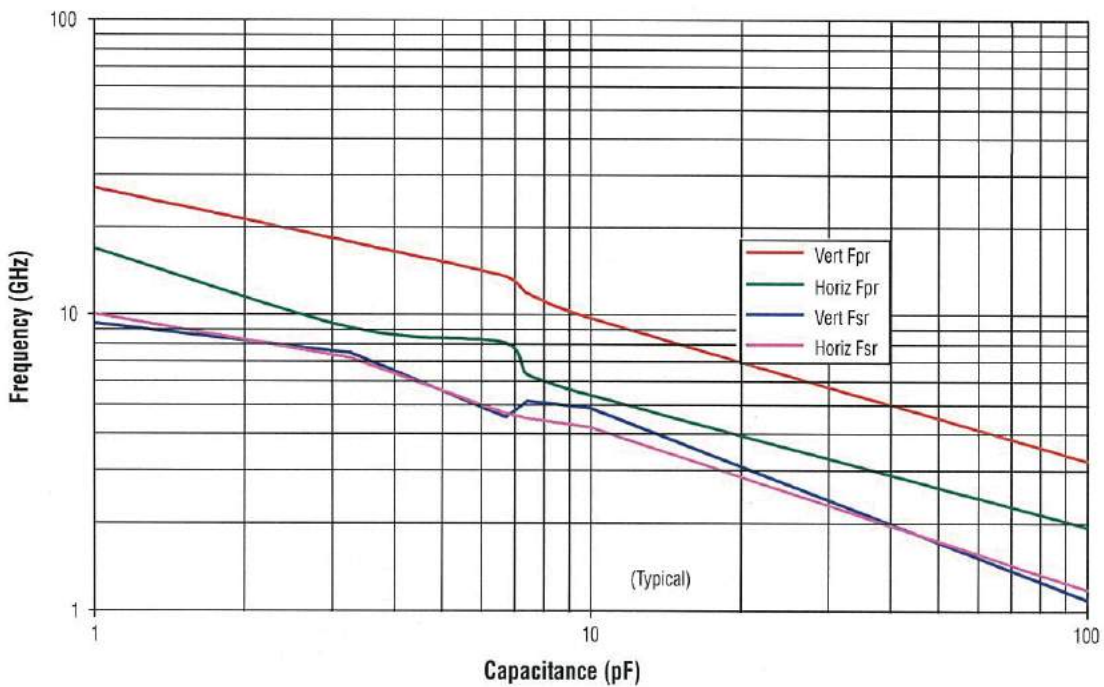

6

UQ CB ESR vs. Frequency

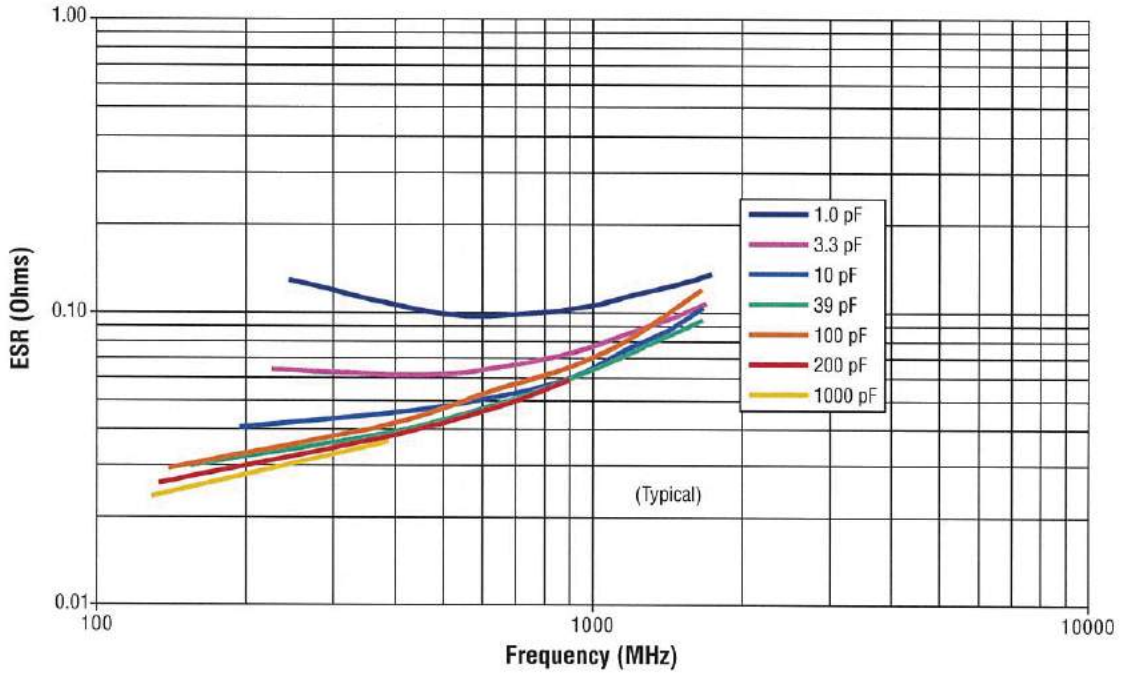

UQ CB FSR & FPR vs. Capacitance

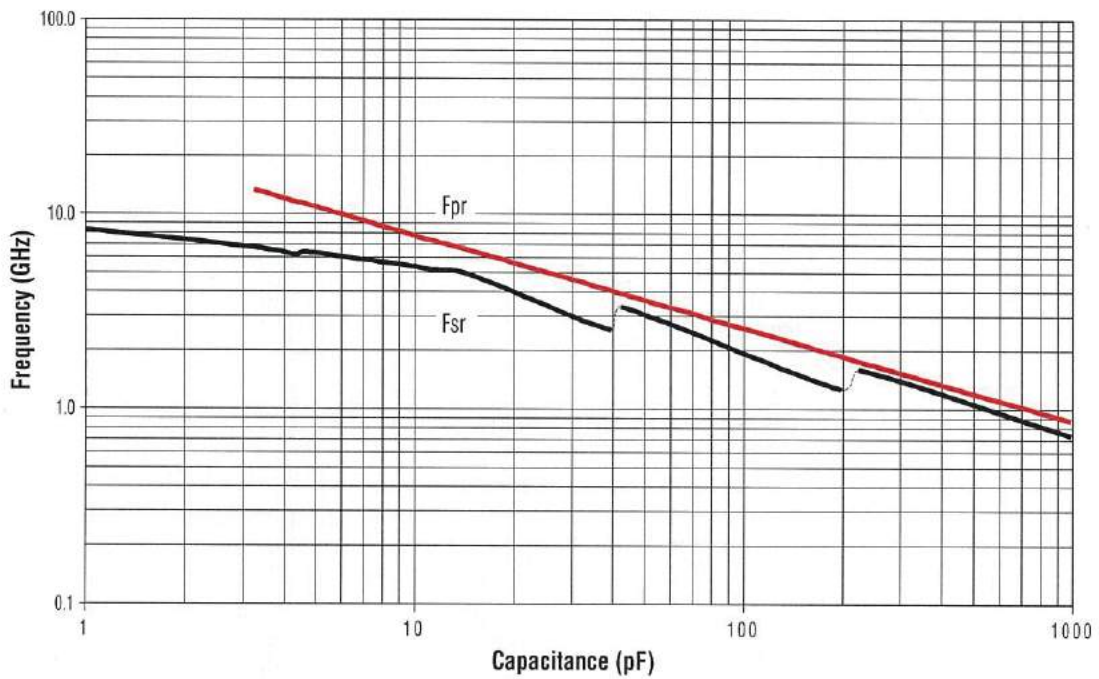

6

UQ CR ESR vs. Frequency

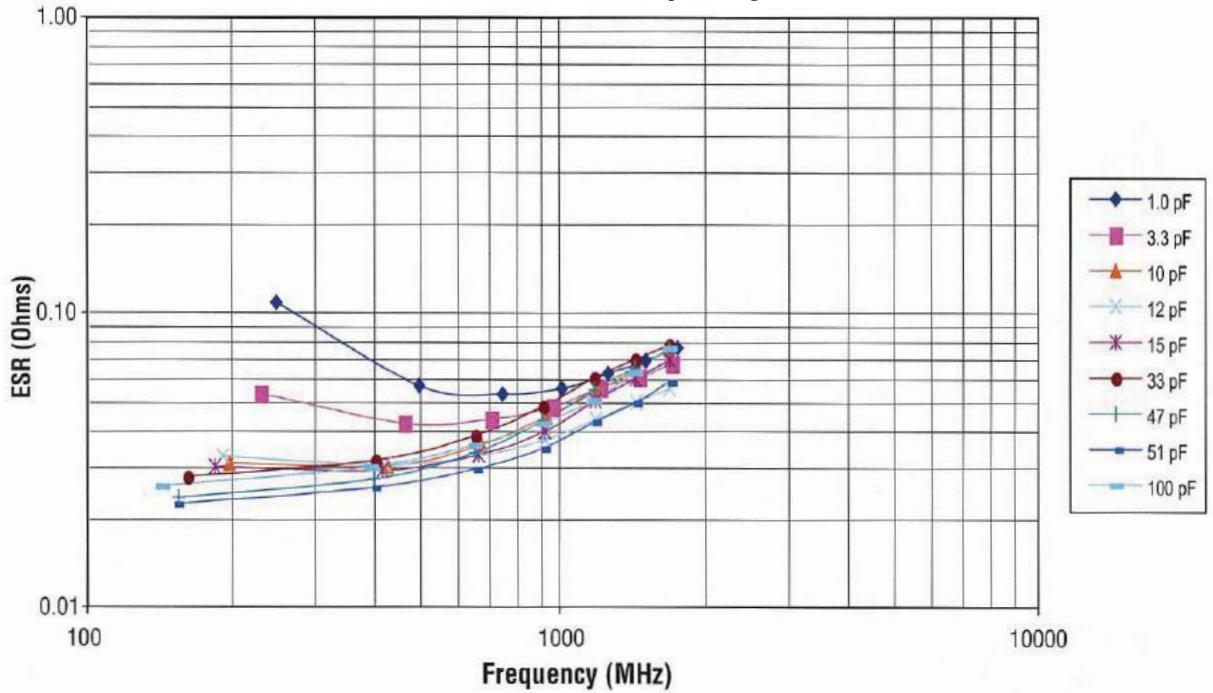

UQ CR Resonance Horizontal Orientation

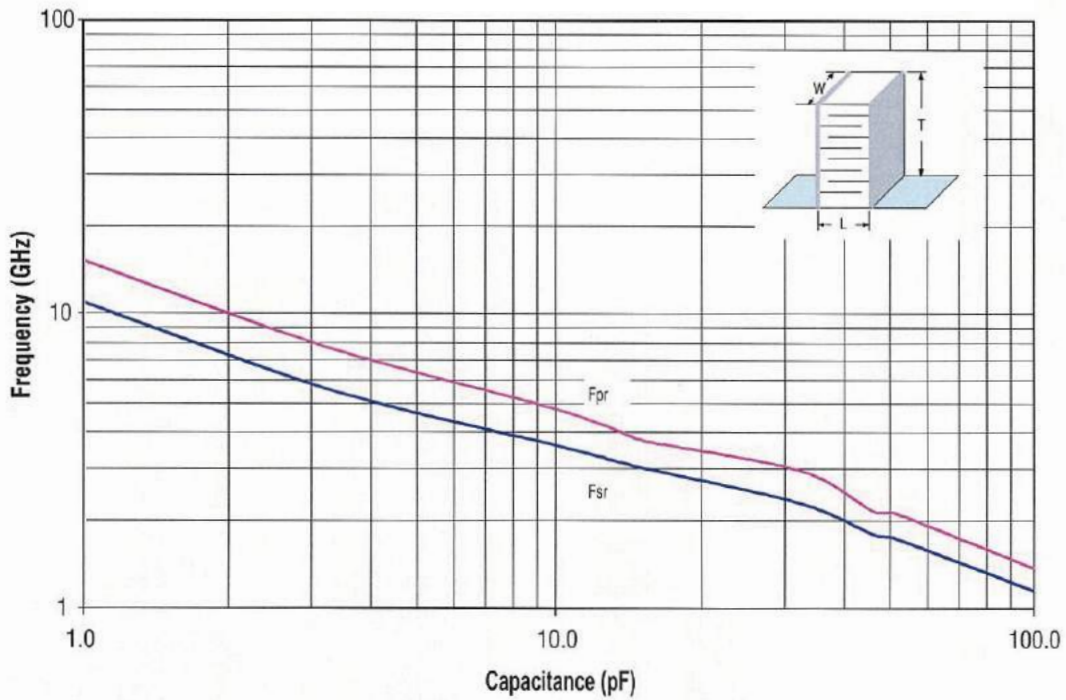

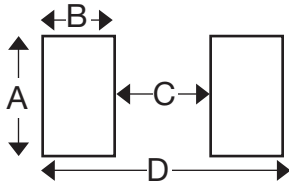

MOUNTING PAD DIMENSIONS CASE CA: inches (millimeters)

	Pad Size	A min	B min	C min	D min
Vertical Mount	Normal	0.070 (1.778)	0.050 (1.270)	0.030 (0.762)	0.130 (3.302)
	High Density	0.050 (1.270)	0.030 (0.762)	0.030 (0.762)	0.090 (2.286)
Horizontal Mount	Normal	0.080 (2.032)	0.050 (1.270)	0.030 (0.762)	0.130 (3.302)
	High Density	0.060 (1.524)	0.030 (0.762)	0.030 (0.762)	0.090 (2.286)

MOUNTING PAD DIMENSIONS CASE CB: inches (millimeters)

	Cap Value	Pad Size	A min	B min	C min	D min
Vertical Mount	0.1 pF	Normal	0.065 (1.651)	0.050 (1.270)	0.075 (1.905)	0.175 (4.445)
		High Density	0.045 (1.143)	0.030 (0.762)	0.075 (1.905)	0.135 (3.429)
	0.2 pF	Normal	0.090 (2.286)	0.050 (1.270)	0.075 (1.905)	0.175 (4.445)
		High Density	0.070 (1.778)	0.030 (0.762)	0.075 (1.905)	0.135 (3.429)
	0.3 to 510 pF	Normal	0.110 (2.794)	0.050 (1.270)	0.075 (1.905)	0.175 (4.445)
		High Density	0.090 (2.286)	0.030 (0.762)	0.075 (1.905)	0.135 (3.429)
> 510 pF	Normal	0.120 (3.048)	0.050 (1.270)	0.075 (1.905)	0.175 (4.445)	
	High Density	0.100 (2.540)	0.030 (0.762)	0.075 (1.905)	0.135 (3.429)	
Horizontal Mount	All Values	Normal	0.130 (3.302)	0.050 (1.270)	0.075 (1.905)	0.175 (4.445)
		High Density	0.110 (2.794)	0.030 (0.762)	0.075 (1.905)	0.135 (3.429)

MK Series Capacitors



Ultra Low ESR, C0G (NP0) Chip Capacitors

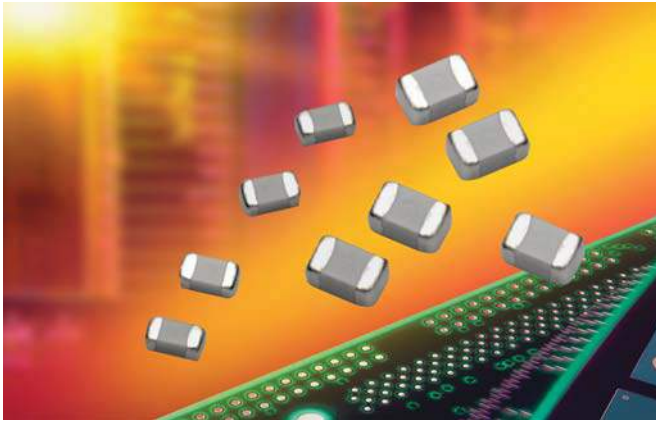

GENERAL INFORMATION

Capacitors are C0G (NP0) chip capacitors specially designed for "Ultra" low ESR for applications in the communications market. Max ESR and effective capacitance are met on each value producing lot to lot uniformity. Sizes available are EIA chip sizes 0402, 0603, 0805, and 1210.

DIMENSIONS: inches (millimeters)

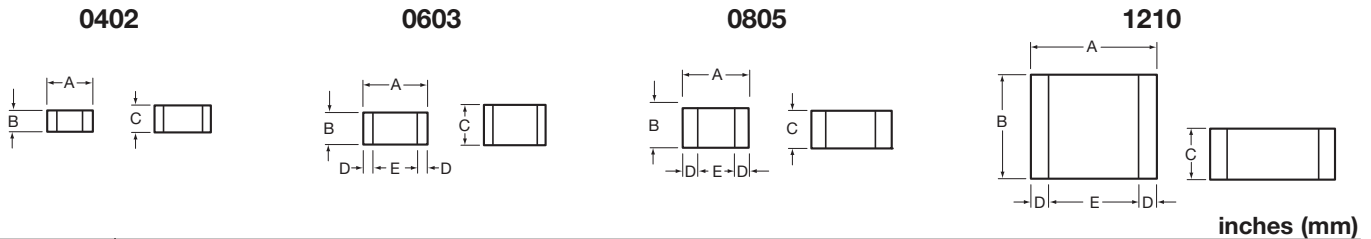

Size	A	B	C	D	E
0402	0.039±0.004 (1.00±0.1)	0.020±0.004 (0.50±0.1)	0.024 (0.6) max	N/A	N/A
0603	0.060±0.010 (1.52±0.25)	0.030±0.010 (0.76±0.25)	0.036 (0.91) max	0.010±0.005 (0.25±0.13)	0.030 (0.76) min
0805	0.079±0.008 (2.01±0.2)	0.049±0.008 (1.25±0.2)	0.040±0.005 (1.02±0.127)	0.020±0.010 (0.51±0.254)	0.020 (0.51) min
1210	0.126±0.008 (3.2±0.2)	0.098±0.008 (2.49±0.2)	0.050±0.005 (1.27±0.127)	0.025±0.015 (0.635±0.381)	0.040 (1.02) min

HOW TO ORDER

6

MK05 | **V** | **7** | **100** | **J** | **A** | **T** | **2** | **A**

- Case Size**
MK02 = 0402
MK03 = 0603
MK05 = 0805
MK10 = 1210
- Voltage Code**
3 = 25V
5 = 50V
1 = 100V
2 = 200V
V = 250V
7 = 500V
- Dielectric = Ultra Low ESR**
- Capacitance**
EIA Capacitance Code in pF.
First two digits = significant figures or "R" for decimal place.
Third digit = number of zeros or after "R" significant figures.
- Capacitance Tolerance Code**
B = ±0.1pF
C = ±0.25pF
D = ±0.5pF
F = ±1%
G = ±2%
J = ±5%
K = ±10%
M = ±20%
- Failure Rate Code**
A = Not Applicable
- Termination**
T = 100% Tin
- Packaging Code**
2 = 7" Reel
4 = 13" Reel
9 = Bulk
- Special Code**
A = Standard



Please select correct termination style

MK Series Capacitors



Ultra Low ESR, C0G (NP0) Chip Capacitors

ELECTRICAL CHARACTERISTICS

Capacitance Values and Tolerances:

- Size MK02 - 0.2 pF to 30 pF @ 1 MHz
- Size MK03 - 0.2 pF to 120 pF @ 1 MHz
- Size MK05 - 1.0 pF to 160 pF @ 1 MHz
- Size MK10 - 1.0 pF to 1000 pF @ 1 MHz

Temperature Coefficient of Capacitance (TC):

0±30 ppm/°C (-55° to +125°C)

Insulation Resistance (IR):

- 10¹² Ω min. @ 25°C and rated WVDC
- 10¹¹ Ω min. @ 125°C and rated WVDC

Working Voltage (WVDC):

- Size Working Voltage
- MK02 - 50, 25 WVDC
- MK03 - 250, 200, 100, 50 WVDC
- MK05 - 250 WVDC
- MK10 - 500, 200, 100 WVDC

Dielectric Working Voltage (DWV):

250% of rated WVDC

Equivalent Series Resistance Typical (ESR):

- MK02 - See Performance Curve, page 3
- MK03 - See Performance Curve, page 3
- MK05 - See Performance Curve, page 3
- MK10 - See Performance Curve, page 3

MILITARY SPECIFICATIONS

Meets or exceeds the requirements of MIL-C-55681

CAPACITANCE RANGE

Cap (pF)	Available	Size			
	Tolerance	MK02	MK03	MK05	MK10
0.2	B,C	50V	250V	N/A	N/A
0.3	↓	↓	↓	↓	↓
0.4	↓	↓	↓	↓	↓
0.5	B,C	↓	↓	↓	↓
0.6	B,C,D	↓	↓	↓	↓
0.7	↓	↓	↓	↓	↓
0.8	↓	↓	↓	↓	↓
0.9	B,C,D	↓	↓	↓	↓

Cap (pF)	Available	Size			
	Tolerance	MK02	MK03	MK05	MK10
1.0	B,C,D	50V	250V	250V	500V
1.1	↓	↓	↓	↓	↓
1.2	↓	↓	↓	↓	↓
1.3	↓	↓	↓	↓	↓
1.4	↓	↓	↓	↓	↓
1.5	↓	↓	↓	↓	↓
1.6	↓	↓	↓	↓	↓
1.7	↓	↓	↓	↓	↓
1.8	↓	↓	↓	↓	↓
1.9	↓	↓	↓	↓	↓
2.0	↓	↓	↓	↓	↓
2.1	↓	↓	↓	↓	↓
2.2	↓	↓	↓	↓	↓
2.4	↓	↓	↓	↓	↓
2.7	↓	↓	↓	↓	↓
3.0	↓	↓	↓	↓	↓
3.3	↓	↓	↓	↓	↓
3.6	↓	↓	↓	↓	↓
3.9	↓	↓	↓	↓	↓
4.3	↓	↓	↓	↓	↓
4.7	↓	↓	↓	↓	↓
5.1	↓	↓	↓	↓	↓
5.6	↓	↓	↓	↓	↓
6.2	B,C,D	↓	↓	↓	↓
6.8	B,C,J,K,M	↓	↓	↓	↓

Cap (pF)	Available	Size			
	Tolerance	MK02	MK03	MK05	MK10
7.5	B,C,J,K,M	50V	250V	250V	500V
8.2	↓	↓	↓	↓	↓
9.1	B,C,J,K,M	↓	↓	↓	↓
10	F,G,J,K,M	↓	↓	↓	↓
11	↓	↓	↓	↓	↓
12	↓	↓	↓	↓	↓
13	↓	↓	↓	↓	↓
15	↓	↓	↓	↓	↓
18	↓	↓	↓	↓	↓
20	↓	↓	↓	↓	↓
22	↓	↓	↓	↓	↓
24	↓	↓	↓	↓	↓
27	↓	↓	↓	↓	↓
30	↓	N/A	↓	↓	↓
33	↓	↓	↓	↓	↓
36	↓	↓	↓	↓	↓
39	↓	↓	↓	↓	↓
43	↓	↓	↓	↓	↓
47	↓	↓	↓	↓	↓
51	↓	↓	↓	↓	↓
56	↓	↓	↓	↓	↓
68	↓	↓	100V	↓	↓
75	↓	↓	↓	↓	↓
82	↓	↓	↓	↓	↓
91	↓	↓	↓	↓	↓

Cap (pF)	Available	Size			
	Tolerance	MK02	MK03	MK05	MK10
100	F,G,J,K,M	N/A	100V	250V	500V
110	↓	↓	50V	↓	↓
120	↓	↓	50V	↓	↓
130	↓	↓	50V	↓	↓
140	↓	↓	N/A	↓	↓
150	↓	↓	↓	↓	↓
160	↓	↓	↓	↓	↓
180	↓	↓	↓	N/A	↓
200	↓	↓	↓	↓	200
220	↓	↓	↓	↓	↓
270	↓	↓	↓	↓	↓
300	↓	↓	↓	↓	↓
330	↓	↓	↓	↓	↓
360	↓	↓	↓	↓	↓
390	↓	↓	↓	↓	↓
430	↓	↓	↓	↓	↓
470	↓	↓	↓	↓	↓
510	↓	↓	↓	↓	↓
560	↓	↓	↓	↓	↓
620	↓	↓	↓	↓	↓
680	↓	↓	↓	↓	↓
750	↓	↓	↓	↓	↓
820	↓	↓	↓	↓	↓
910	↓	↓	↓	↓	↓
1000	F,G,J,K,M	↓	↓	↓	↓

6



Please select correct termination style

MK Series Capacitors

Ultra Low ESR, C0G (NP0) Chip Capacitors



6

MK02 Q vs Frequency
0402

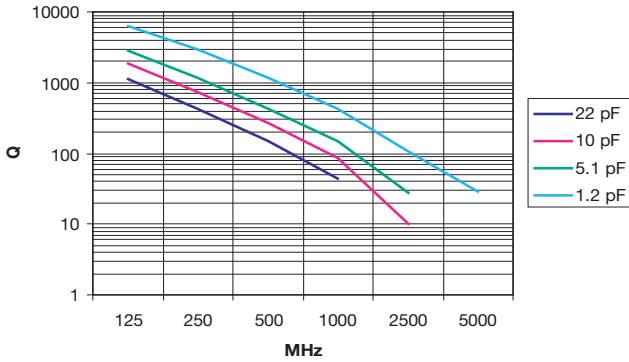

MK02 ESR vs Frequency
0402

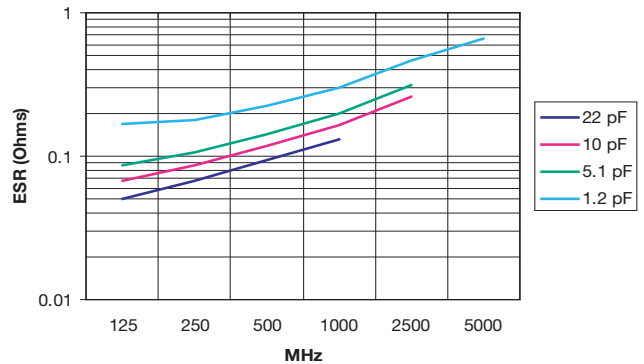

MK03 Q vs Frequency
0603

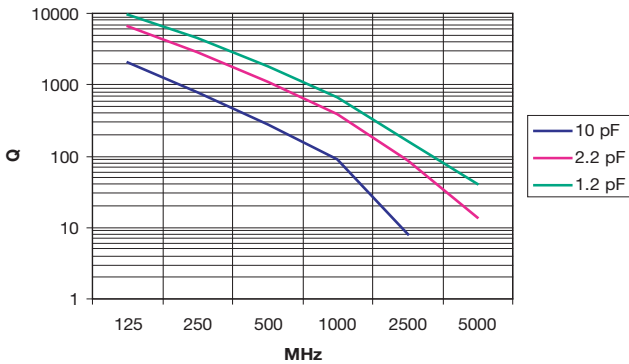

MK03 ESR vs Frequency
0603

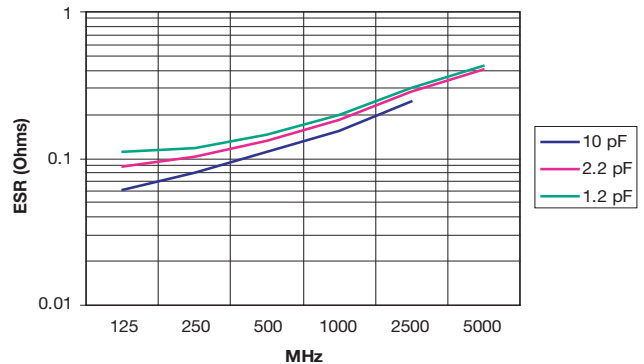

MK05 Q vs Frequency
0805

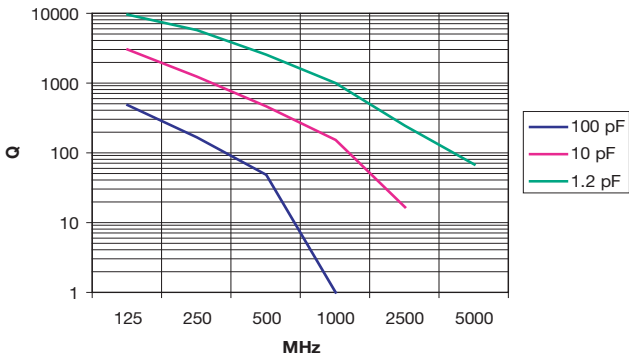

MK05 ESR vs Frequency
0805

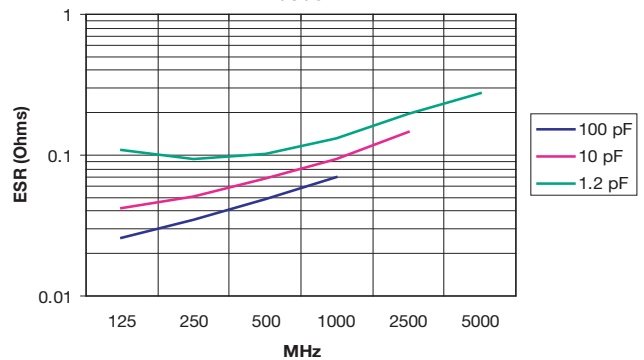

MK10 Q vs Frequency
1210

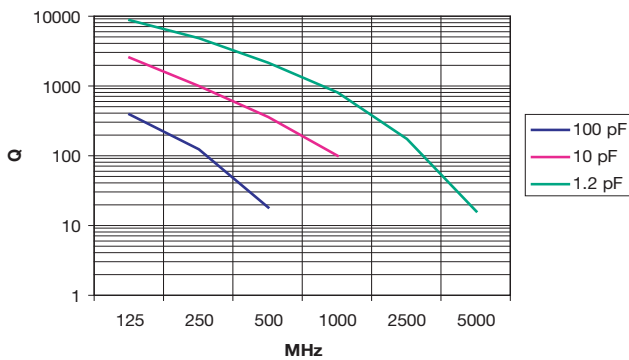

MK10 ESR vs Frequency
1210

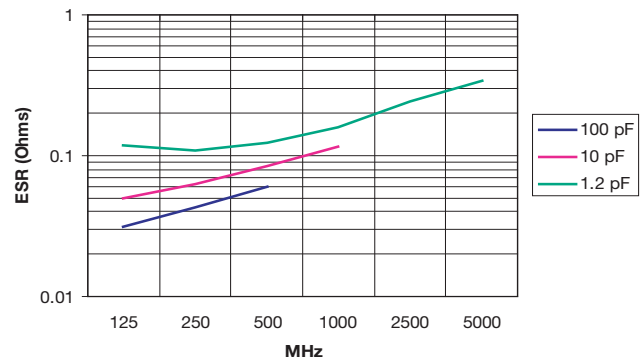

Microwave MLC's



SQ A Case & B Case Ultra Low ESR MLC

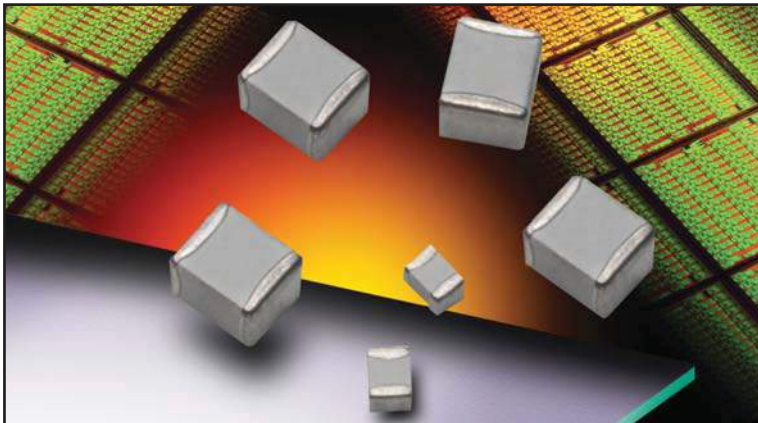

FEATURES:

- Low ESR
- High Q
- High Self Resonance
- Capacitance Range 0.1 pF to 5100 pF
- 175°C Capability SQCB

APPLICATIONS:

- RF Power Amplifiers
- Low Noise Amplifiers
- Filter Networks
- MRI Systems

HOW TO ORDER

<p>SQ</p> <p>AVX Style</p>	<p>CB</p> <p>Case Size CA = * CB = *</p> <p>* See mechanical dimensions below</p>	<p>7</p> <p>Voltage Code 5 = 50V 1 = 100V E = 150V 2 = 200V V = 250V 9 = 300V 7 = 500V</p>	<p>M</p> <p>Temperature Coefficient Code M = +90±20ppm/°C A = 0±30ppm/°C C = 15% ("J" Termination only)</p>	<p>100</p> <p>Capacitance EIA Capacitance Code in pF. First two digits = significant figures or "R" for decimal place. Third digit = number of zeros or after "R" significant figures.</p>	<p>J</p> <p>Capacitance Tolerance Code B = ±.1 pF C = ±.25 pF D = ±.5 pF F = ±1% G = ±2% J = ±5% K = ±10% M = ±20% N = ±30%</p>	<p>A</p> <p>Failure Rate Code A = Not Applicable</p>	<p>T</p> <p>Termination Style Code **1 = Pd/Ag **7 = Ag/Ni/Au J = Nickel Barrier Sn/Pb (60/40) **T = 100% Tin H = Cu/Sn (Non-Magnetic)</p> <p>**RoHS Compliant</p>	<p>1A</p> <p>Packaging Code 1A = 7" Reel Unmarked 6A = Waffle Pack Unmarked ME = 7" Reel Marked WE = Waffle Pack Unmarked</p> <p>* Vertical T&R available * 500 piece reels available</p>
-----------------------------------	---	--	---	--	---	--	--	---

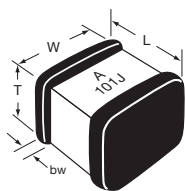

MECHANICAL DIMENSIONS: inches (millimeters)

Case	Length (L)	Width (W)	Thickness (T)	Band Width (bw)
SQCA*	.055 + .015 - .010 (1.40+ .381 -.254)	.055±.015 (1.40±.381)	.020/.057 (.508/1.45)	.010 + .010 - .005 (.254 +.254 -.127)
SQCB*	.110 + .020 - .010 (2.79 +.508 -.254)	.110±.010 (2.79±.254)	.030/.102 (.762/2.59)	.015±.010 (.381±.254)

TAPE & REEL: All tape and reel specifications are in compliance with EIA RS481 (equivalent to IEC 286 part 3).

- 8mm carrier
- 7" reel: SQCA/SQCB = 2000 pcs (500 piece reels SQCA SQCB)

WAFFLE PACK

- SQCA 100 pcs
- SQCB 80 pcs



ELECTRICAL SPECIFICATIONS

		M & A	C
Temperature Coefficient (TCC)		(M) $+90 \pm 20$ PPM/°C (-55°C to +125°C) (M) $+90 \pm 30$ PPM/°C (+125°C to +175°C)* (A) 0 ± 30 PPM/°C	$\pm 15\%$ (-55°C to 125°C)
Capacitance Range		(M) 0.1 pF to 1000 pF (A) 0.1 pF to 5100 pF	0.001 μ F to 0.1 μ F
Operating Temperature		0.1 pF to 330 pF: from -55°C to +175°C* 360 pF to 5100 pF: from -55°C to +125°C	-55°C to +125°C
Quality Factor (Q)	M Dielectric A & B Case	Greater than 10,000 at 1 MHz	2.5% @ 1kHz
	A Dielectric B Case	Greater than 10,000 at 1 MHz Greater than 2,000 at 1 MHz Greater than 2,000 at 1 KHz	0.1 - 200 pF 220 - 1000 pF 1100 - 5100 pF
	A Dielectric A Case	Greater than 10,000 at 1 MHz Greater than 2,000 at 1 MHz	0.1 - 100 pF 110 - 1000 pF
Insulation Resistance (IR)		0.2 pF to 470 pF 10 ⁹ Megohms min. @ 25°C at rated WVDC 10 ⁹ Megohms min. @ 125°C at rated WVDC 510 pF to 5100 pF 10 ⁹ Megohms min. @ 25°C at rated WVDC 10 ⁹ Megohms min. @ 125°C at rated WVDC	10 ⁴ Megohms min. @ 25°C at rated WVDC 10 ³ Megohms min. @ 125°C at rated WVDC
Working Voltage (WVDC)		See Capacitance Values table	See Capacitance Values table
Dielectric Withstanding Voltage (DWV)		250% of rated WVDC for 5 secs (for 500V rated 150% of rated voltage)	250% of rated WVDC for 5 secs
Aging Effects		None	<3% per decade hour
Piezoelectric Effects		None	None
Capacitance Drift		\pm (0.02% or 0.02 pF), whichever is greater	Not Applicable

* 175 SQCB & SQLB only

ENVIRONMENTAL CHARACTERISTICS

AVX SQ will meet and exceed the requirements of EIA-198, MIL-PRF-55681 and MIL-PRF-123

Thermal Shock	Mil-STD-202, Method 107, Condition A
Moisture Resistance	Mil-STD-202, Method 106
Low Voltage Humidity	Mil-STD-202, Method 103, condition A, with 1.5 VDC applied while subjected to an environment of 85°C with 85% relative humidity for 240 hours
Life Test	Mil-STD-202, Method 108, for 2000 hours at 125°C
Shock	Mil-STD-202, Method 213, Condition J
Vibration	Mil-STD-202, Method 204, Condition B
Immersion	Mil-STD-202, Method 104, Condition B
Salt Spray	Mil-STD-202, Method 101, Condition B
Solderability	Mil-STD-202, Method 208
Terminal Strength	Mil-STD-202, Method 211
Temperature Cycling	Mil-STD-202, Method 102, Condition C
Barometric Pressure	Mil-STD-202, Method 105, Condition B
Resistance to Solder Heat	Mil-STD-202, Method 210, Condition C

Case Size A

TABLE I: TC: M (+90±20PPM/°C)

Cap. pF	Cap. Tol.	WVDC	Cap. pF	Cap. Tol.	WVDC	Cap. pF	Cap. Tol.	WVDC	Cap. pF	Cap. Tol.	WVDC
0.1	B	150, 250	1.7	B, C, D	150, 250	6.2	B, C, D	150, 250	27	F, G, J, K	150, 250
0.2	B	150, 250	1.8	B, C, D	150, 250	6.8	B, C, J, K	150, 250	30	F, G, J, K	150, 250
0.3	B,C	150, 250	1.9	B, C, D	150, 250	7.5	B, C, J, K	150, 250	33	F, G, J, K	150, 250
0.4	B,C	150, 250	2.0	B, C, D	150, 250	8.2	B, C, J, K	150, 250	36	F, G, J, K	150, 250
0.5	B, C, D	150, 250	2.2	B, C, D	150, 250	9.1	B, C, J, K	150, 250	39	F, G, J, K	150, 250
0.6	B, C, D	150, 250	2.4	B, C, D	150, 250	10	F, G, J, K	150, 250	43	F, G, J, K	150, 250
0.7	B, C, D	150, 250	2.7	B, C, D	150, 250	11	F, G, J, K	150, 250	47	F, G, J, K	150, 250
0.8	B, C, D	150, 250	3.0	B, C, D	150, 250	12	F, G, J, K	150, 250	51	F, G, J, K	150, 250
0.9	B, C, D	150, 250	3.3	B, C, D	150, 250	13	F, G, J, K	150, 250	56	F, G, J, K	150, 250
1.0	B, C, D	150, 250	3.6	B, C, D	150, 250	15	F, G, J, K	150, 250	62	F, G, J, K	150, 250
1.1	B, C, D	150, 250	3.9	B, C, D	150, 250	16	F, G, J, K	150, 250	68	F, G, J, K	150, 250
1.2	B, C, D	150, 250	4.3	B, C, D	150, 250	18	F, G, J, K	150, 250	75	F, G, J, K	150, 250
1.3	B, C, D	150, 250	4.7	B, C, D	150, 250	20	F, G, J, K	150, 250	82	F, G, J, K	150, 250
1.4	B, C, D	150, 250	5.1	B, C, D	150, 250	22	F, G, J, K	150, 250	91	F, G, J, K	150, 250
1.5	B, C, D	150, 250	5.6	B, C, D	150, 250	24	F, G, J, K	150, 250	100	F, G, J, K	150, 250
1.6	B, C, D	150, 250									

TABLE II: TC: A (0±30PPM/°C)

Cap. pF	Cap. Tol.	WVDC	Cap. pF	Cap. Tol.	WVDC	Cap. pF	Cap. Tol.	WVDC	Cap. pF	Cap. Tol.	WVDC
0.1	B	150	2.7	B, C, D	150	20	F, G, J, K	150	150	F, G, J, K	50
0.2	B	150	3.0	B, C, D	150	22	F, G, J, K	150	160	F, G, J, K	50
0.3	B,C	150	3.3	B, C, D	150	24	F, G, J, K	150	180	F, G, J, K	50
0.4	B,C	150	3.6	B, C, D	150	27	F, G, J, K	150	200	F, G, J, K	50
0.5	B, C, D	150	3.9	B, C, D	150	30	F, G, J, K	150	220	F, G, J, K	50
0.6	B, C, D	150	4.3	B, C, D	150	33	F, G, J, K	150	240	F, G, J, K	50
0.7	B, C, D	150	4.7	B, C, D	150	36	F, G, J, K	150	270	F, G, J, K	50
0.8	B, C, D	150	5.1	B, C, D	150	39	F, G, J, K	150	300	F, G, J, K	50
0.9	B, C, D	150	5.6	B, C, D	150	43	F, G, J, K	150	330	F, G, J, K	50
1.0	B, C, D	150	6.2	B, C, D	150	47	F, G, J, K	150	360	F, G, J, K	50
1.1	B, C, D	150	6.8	B, C, J, K	150	51	F, G, J, K	150	390	F, G, J, K	50
1.2	B, C, D	150	7.5	B, C, J, K	150	56	F, G, J, K	150	430	F, G, J, K	50
1.3	B, C, D	150	8.2	B, C, J, K	150	62	F, G, J, K	150	470	F, G, J, K	50
1.4	B, C, D	150	9.1	B, C, J, K	150	68	F, G, J, K	150	510	F, G, J, K	50
1.5	B, C, D	150	10	F, G, J, K	150	75	F, G, J, K	150	560	F, G, J, K	50
1.6	B, C, D	150	11	F, G, J, K	150	82	F, G, J, K	150	620	F, G, J, K	50
1.7	B, C, D	150	12	F, G, J, K	150	91	F, G, J, K	150	680	F, G, J, K	50
1.8	B, C, D	150	13	F, G, J, K	150	100	F, G, J, K	150	750	F, G, J, K	50
1.9	B, C, D	150	15	F, G, J, K	150	110	F, G, J, K	50	820	F, G, J, K	50
2.0	B, C, D	150	16	F, G, J, K	150	120	F, G, J, K	50	910	F, G, J, K	50
2.2	B, C, D	150	18	F, G, J, K	150	130	F, G, J, K	50	1000	F, G, J, K	50
2.4	B, C, D	150									

TABLE III: TC: C (±15%)

Cap. pF	Cap. Tol.	WVDC	Cap. pF	Cap. Tol.	WVDC	Cap. pF	Cap. Tol.	WVDC
1000	K, M, N	50	2200	K, M, N	50	5100	K, M, N	50
1200	K, M, N	50	2700	K, M, N	50	5600	K, M, N	50
1500	K, M, N	50	3300	K, M, N	50	6800	K, M, N	50
1800	K, M, N	50	3900	K, M, N	50	8200	K, M, N	50
2000	K, M, N	50	4700	K, M, N	50	10000	K, M, N	50

Microwave MLC's



SQ Series Available Capacitance/Size/WVDC/T.C.

Case Size B

TABLE IV: TC: M (+90±20PPM/°C)

Cap. pF	Cap. Tol.	WVDC	Cap. pF	Cap. Tol.	WVDC	Cap. pF	Cap. Tol.	WVDC	Cap. pF	Cap. Tol.	WVDC
0.1	B	500	2.7	B, C, D	500	20	F, G, J, K	500	150	F, G, J, K	300
0.2	B	500	3.0	B, C, D	500	22	F, G, J, K	500	160	F, G, J, K	300
0.3	B,C	500	3.3	B, C, D	500	24	F, G, J, K	500	180	F, G, J, K	300
0.4	B,C	500	3.6	B, C, D	500	27	F, G, J, K	500	200	F, G, J, K	300
0.5	B, C, D	500	3.9	B, C, D	500	30	F, G, J, K	500	220	F, G, J, K	200
0.6	B, C, D	500	4.3	B, C, D	500	33	F, G, J, K	500	240	F, G, J, K	200
0.7	B, C, D	500	4.7	B, C, D	500	36	F, G, J, K	500	270	F, G, J, K	200
0.8	B, C, D	500	5.1	B, C, D	500	39	F, G, J, K	500	300	F, G, J, K	200
0.9	B, C, D	500	5.6	B, C, D	500	43	F, G, J, K	500	330	F, G, J, K	200
1.0	B, C, D	500	6.2	B, C, D	500	47	F, G, J, K	500	360	F, G, J, K	200
1.1	B, C, D	500	6.8	B, C, J, K	500	51	F, G, J, K	500	390	F, G, J, K	200
1.2	B, C, D	500	7.5	B, C, J, K	500	56	F, G, J, K	500	430	F, G, J, K	200
1.3	B, C, D	500	8.2	B, C, J, K	500	62	F, G, J, K	500	470	F, G, J, K	200
1.4	B, C, D	500	9.1	B, C, J, K	500	68	F, G, J, K	500	510	F, G, J, K	150
1.5	B, C, D	500	10	F, G, J, K	500	75	F, G, J, K	500	560	F, G, J, K	150
1.6	B, C, D	500	11	F, G, J, K	500	82	F, G, J, K	500	620	F, G, J, K	150
1.7	B, C, D	500	12	F, G, J, K	500	91	F, G, J, K	500	680	F, G, J, K	150
1.8	B, C, D	500	13	F, G, J, K	500	100	F, G, J, K	500	750	F, G, J, K	150
1.9	B, C, D	500	15	F, G, J, K	500	110	F, G, J, K	300	820	F, G, J, K	150
2.0	B, C, D	500	16	F, G, J, K	500	120	F, G, J, K	300	910	F, G, J, K	150
2.2	B, C, D	500	18	F, G, J, K	500	130	F, G, J, K	300	1000	F, G, J, K	150
2.4	B, C, D	500									

TABLE V: TC: A (0±30PPM/°C)

Cap. pF	Cap. Tol.	WVDC	Cap. pF	Cap. Tol.	WVDC	Cap. pF	Cap. Tol.	WVDC	Cap. pF	Cap. Tol.	WVDC
0.1	B	500	3.9	B, C, D	500	47	F, G, J, K	500	560	F, G, J, K	150
0.2	B	500	4.3	B, C, D	500	51	F, G, J, K	500	620	F, G, J, K	150
0.3	B,C	500	4.7	B, C, D	500	56	F, G, J, K	500	680	F, G, J, K	150
0.4	B,C	500	5.1	B, C, D	500	62	F, G, J, K	500	750	F, G, J, K	150
0.5	B, C, D	500	5.6	B, C, D	500	68	F, G, J, K	500	820	F, G, J, K	150
0.6	B, C, D	500	6.2	B, C, D	500	75	F, G, J, K	500	910	F, G, J, K	150
0.7	B, C, D	500	6.8	B, C, J, K	500	82	F, G, J, K	500	1000	F, G, J, K	150
0.8	B, C, D	500	7.5	B, C, J, K	500	91	F, G, J, K	500	1100	F, G, J, K	50
0.9	B, C, D	500	8.2	B, C, J, K	500	100	F, G, J, K	500	1200	F, G, J, K	50
1.0	B, C, D	500	9.1	B, C, J, K	500	110	F, G, J, K	300	1300	F, G, J, K	50
1.1	B, C, D	500	10	F, G, J, K	500	120	F, G, J, K	300	1500	F, G, J, K	50
1.2	B, C, D	500	11	F, G, J, K	500	130	F, G, J, K	300	1600	F, G, J, K	50
1.3	B, C, D	500	12	F, G, J, K	500	150	F, G, J, K	300	1800	F, G, J, K	50
1.4	B, C, D	500	13	F, G, J, K	500	160	F, G, J, K	300	2000	F, G, J, K	50
1.5	B, C, D	500	15	F, G, J, K	500	180	F, G, J, K	300	2200	F, G, J, K	50
1.6	B, C, D	500	16	F, G, J, K	500	200	F, G, J, K	300	2400	F, G, J, K	50
1.7	B, C, D	500	18	F, G, J, K	500	220	F, G, J, K	200	2700	F, G, J, K	50
1.8	B, C, D	500	20	F, G, J, K	500	240	F, G, J, K	200	3000	F, G, J, K	50
1.9	B, C, D	500	22	F, G, J, K	500	270	F, G, J, K	200	3300	F, G, J, K	50
2.0	B, C, D	500	24	F, G, J, K	500	300	F, G, J, K	200	3600	F, G, J, K	50
2.2	B, C, D	500	27	F, G, J, K	500	330	F, G, J, K	200	3900	F, G, J, K	50
2.4	B, C, D	500	30	F, G, J, K	500	360	F, G, J, K	200	4300	F, G, J, K	50
2.7	B, C, D	500	33	F, G, J, K	500	390	F, G, J, K	200	4700	F, G, J, K	50
3.0	B, C, D	500	36	F, G, J, K	500	430	F, G, J, K	200	5000	F, G, J, K	50
3.3	B, C, D	500	39	F, G, J, K	500	470	F, G, J, K	200	5100	F, G, J, K	50
3.6	B, C, D	500	43	F, G, J, K	500	510	F, G, J, K	150			

TABLE VI: TC: C (±15%)

Cap. pF	Cap. Tol.	WVDC	Cap. pF	Cap. Tol.	WVDC	Cap. pF	Cap. Tol.	WVDC
5000	K, M, N	50	15000	K, M, N	50	47000	K, M, N	50
6800	K, M, N	50	18000	K, M, N	50	68000	K, M, N	50
8200	K, M, N	50				82000	K, M, N	50
10000	K, M, N	50	27000	K, M, N	50	100000	K, M, N	50
12000	K, M, N	50	33000	K, M, N	50			
			39000	K, M, N	50			

6



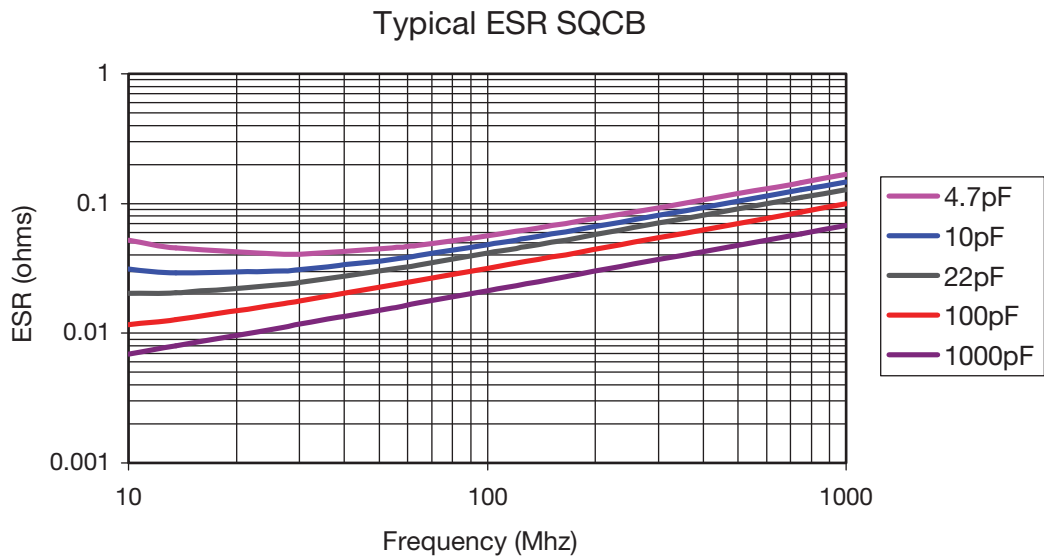
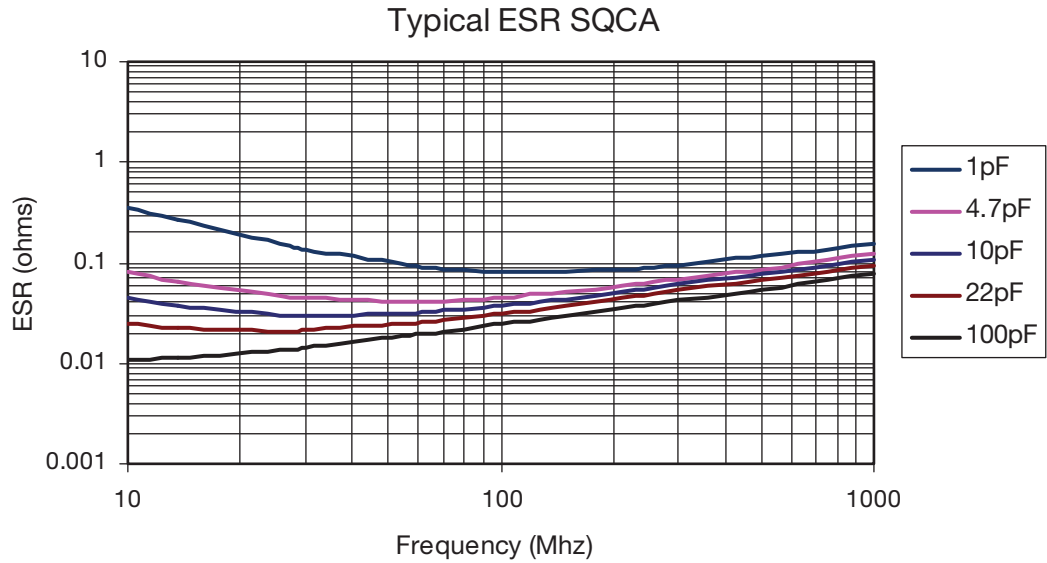

6

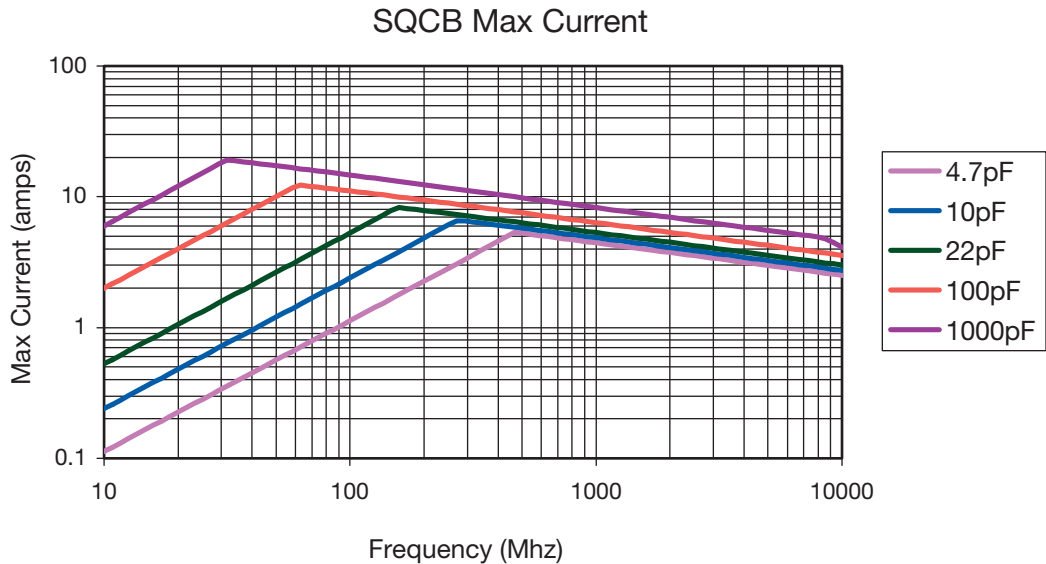
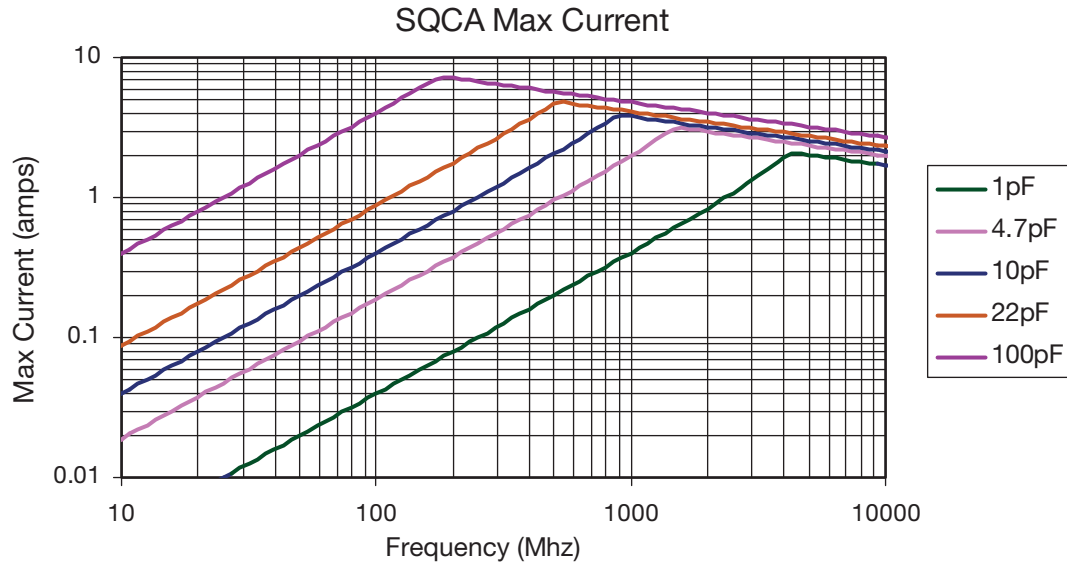

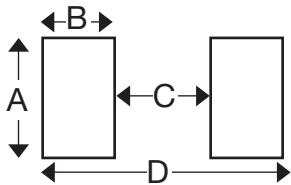
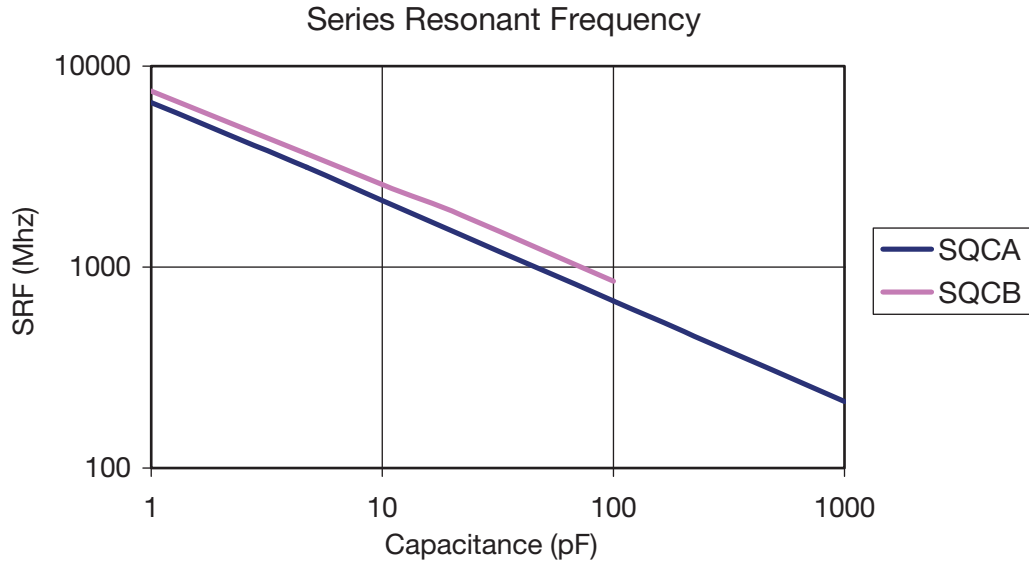

MOUNTING PAD DIMENSIONS: inches (millimeters)

Case	A min	B min	C min	D min
SQCA	0.082 (2.083)	0.051 (1.295)	0.032 (0.813)	0.130 (3.302)
SQCB	0.131 (3.327)	0.051 (1.295)	0.074 (1.880)	0.177 (4.496)
SQCS	0.038 (0.965)	0.043 (1.092)	0.025 (0.635)	0.112 (2.845)
SQCF	0.059 (1.499)	0.051 (1.295)	0.024 (0.610)	0.125 (3.175)

SQCA & SQCB ENGINEERING KITS

PN	Series	Dielectric	Term	Range	Different Values	# per value
Kit SQ005 T	SQCA	P90	100% Tin RoHS	.1 to 10pF	27	20
Kit SQ006 T				10 to 100pF	16	
Kit SQ009 T	SQCA	C0G	100% Tin RoHS	100 to 1000pF	16	15
Kit SQ010 T	SQCB	P90	100% Tin RoHS	.1 to 22pF	32	15
Kit SQ011 T				10 to 1000pF	31	
Kit SQ014 T	SQCB	C0G	100% Tin RoHS	470 to 5100pF	31	15
Kit SQ001	SQCB	P90	Sn/Pb	1 to 1000pF	46	10
Kit SQ002	SQCA	P90	Sn/Pb	.1 to 2pF	17	10
Kit SQ003				2.2 to 10pF	22	

Tolerance per PF:	
B from .1 to 3.3	J from 10 to 1800
C from 3.9 to 8.2	K above 1800

Microwave MLC's



SQCS (0603) SQCF (0805) Ultra Low ESR MLC

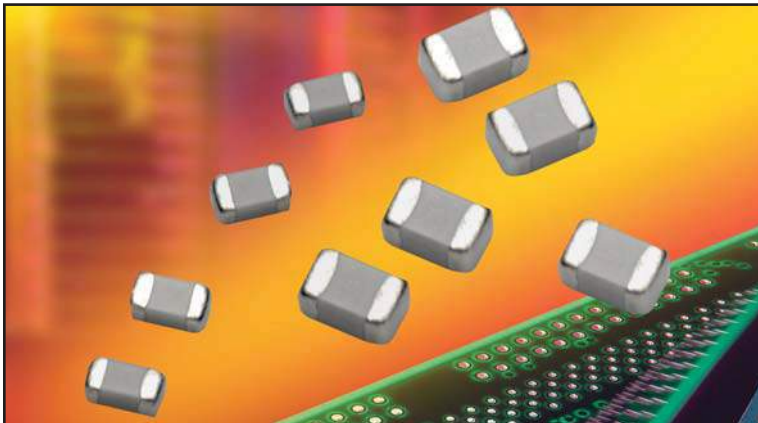

FEATURES:

- Low ESR
- High Q
- High Self Resonance
- Capacitance Range 0.1 pF to 240 pF
- EIA Size

APPLICATIONS:

- RF Power Amplifiers
- Low Noise Amplifiers
- Filter Networks
- Point to Point Radios

HOW TO ORDER

<p>SQ</p> <p>AVX Style</p>	<p>CS</p> <p>Case Size CS = 0603 CF = 0805</p>	<p>V</p> <p>Voltage Code V = 250V</p>	<p>A</p> <p>Temperature Coefficient Code A = 0±30ppm/°C</p>	<p>100</p> <p>Capacitance EIA Capacitance Code in pF. First two digits = significant figures or "R" for decimal place. Third digit = number of zeros or after "R" significant figures.</p>	<p>J</p> <p>Capacitance Tolerance Code A = ±.05 pF B = ±.1 pF C = ±.25 pF D = ±.5 pF F = ±1% G = ±2% J = ±5%</p>	<p>A</p> <p>Failure Rate Code A = Not Applicable</p>	<p>T</p> <p>Termination Style Code **1 = Pd/Ag **7 = Ag/Ni/Au J = Nickel Barrier Sn/Pb (60/40) **T = 100% Tin (Standard)</p>	<p>1A</p> <p>Packaging Code 1A = 7" Reel Unmarked ME = 7" Reel Marked</p> <p>* Vertical T&R available * 500 piece reels available</p>
-----------------------------------	---	--	--	---	---	---	---	--

**RoHS Compliant

6

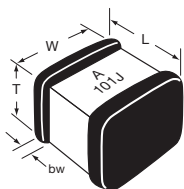

MECHANICAL DIMENSIONS: inches (millimeters)

Case	Length (L)	Width (W)	Thickness (T)	Band Width (bw)
SQCS	.063±.006 (1.60±.152)	.032±.006 (.813±.152)	.030 Max. (.762)	.014±.006 (.357±.152)
SQCF	.079±.008 (2.01±.200)	.049±.008 (1.24±.200)	.045 Max. (1.14)	.014±.006 (.357±.152)

TAPE & REEL: All tape and reel specifications are in compliance with EIA RS481 (equivalent to IEC 286 part 3).

- 8mm carrier
- 7" reel = 4000 pcs (500 piece options)

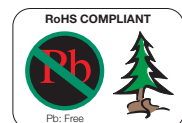

Microwave MLC's

Low ESR MLC Capacitors



ELECTRICAL SPECIFICATIONS

Temperature Coefficient (TCC)	(A) 0 ± 30 PPM/°C
Operating Temperature	-55°C to +125°C
Quality Factor (Q)	Greater than 10,000 at 1 MHz
Insulation Resistance (IR)	0.1 pF to 240 pF 10 ⁶ Megohms min. @ 25°C at rated WVDC 10 ⁶ Megohms min. @ 125°C at rated WVDC
Working Voltage (WVDC)	See Capacitance Values table
Dielectric Withstanding Voltage (DWV)	250% of rated WVDC for 5 secs
Aging Effects	None
Piezoelectric Effects	None
Capacitance Drift	± (0.02% or 0.02 pF), whichever is greater

ENVIRONMENTAL CHARACTERISTICS

AVX SQ will meet and exceed the requirements of EIA-198, MIL-PRF-55681 and MIL-PRF-123

Thermal Shock	Mil-STD-202, Method 107, Condition A
Moisture Resistance	Mil-STD-202, Method 106
Low Voltage Humidity	Mil-STD-202, Method 103, condition A, with 1.5 VDC applied while subjected to an environment of 85°C with 85% relative humidity for 240 hours
Life Test	Mil-STD-202, Method 108, for 2000 hours at 125°C
Shock	Mil-STD-202, Method 213, Condition J
Vibration	Mil-STD-202, Method 204, Condition B
Immersion	Mil-STD-202, Method 104, Condition B
Salt Spray	Mil-STD-202, Method 101, Condition B
Solderability	Mil-STD-202, Method 208
Terminal Strength	Mil-STD-202, Method 211
Temperature Cycling	Mil-STD-202, Method 102, Condition C
Barometric Pressure	Mil-STD-202, Method 105, Condition B
Resistance to Solder Heat	Mil-STD-202, Method 210, Condition C

Microwave MLC's



SQ Series Available Capacitance/Size/WVDC/T.C.

TABLE I: TC: A (0±30PPM/°C) CASE SIZE S

Cap. pF	Cap. Tol.	WVDC	Cap. pF	Cap. Tol.	WVDC	Cap. pF	Cap. Tol.	WVDC
0.1	A, B	250	2.4	A, B, C	250	18	F, G, J	250
0.2	A, B	250	2.7	A, B, C	250	20	F, G, J	250
0.3	A, B	250	3.0	A, B, C	250	22	F, G, J	250
0.4	A, B	250	3.3	A, B, C	250	24	F, G, J	250
0.5	A, B, C	250	3.6	A, B, C	250	27	F, G, J	250
0.6	A, B, C	250	3.9	A, B, C	250	30	F, G, J	250
0.7	A, B, C	250	4.3	A, B, C	250	33	F, G, J	250
0.8	A, B, C	250	4.7	A, B, C	250	36	F, G, J	250
0.9	A, B, C	250	5.1	A, B, C	250	39	F, G, J	250
1.0	A, B, C	250	5.6	A, B, C	250	43	F, G, J	250
1.1	A, B, C	250	6.2	A, B, C	250	47	F, G, J	250
1.2	A, B, C	250	6.8	B, C, D	250	51	F, G, J	250
1.3	A, B, C	250	7.5	B, C, D	250	56	F, G, J	250
1.4	A, B, C	250	8.2	B, C, D	250	62	F, G, J	250
1.5	A, B, C	250	9.1	B, C, D	250	68	F, G, J	250
1.6	A, B, C	250	10	F, G, J	250	75	F, G, J	250
1.7	A, B, C	250	11	F, G, J	250	82	F, G, J	250
1.8	A, B, C	250	12	F, G, J	250	91	F, G, J	250
1.9	A, B, C	250	13	F, G, J	250	100	F, G, J	250
2.0	A, B, C	250	15	F, G, J	250			
2.2	A, B, C	250	16	F, G, J	250			

TABLE II: TC: A (0±30PPM/°C) CASE SIZE F

Cap. pF	Cap. Tol.	WVDC	Cap. pF	Cap. Tol.	WVDC	Cap. pF	Cap. Tol.	WVDC	Cap. pF	Cap. Tol.	WVDC
0.1	A, B	250	2.4	A, B, C	250	18	F, G, J	250	150	F, G, J	250
0.2	A, B	250	2.7	A, B, C	250	20	F, G, J	250	180	F, G, J	250
0.3	A, B	250	3.0	A, B, C	250	22	F, G, J	250	200	F, G, J	250
0.4	A, B	250	3.3	A, B, C	250	24	F, G, J	250	220	F, G, J	250
0.5	A, B, C	250	3.6	A, B, C	250	27	F, G, J	250	240	F, G, J	250
0.6	A, B, C	250	3.9	A, B, C	250	30	F, G, J	250			
0.7	A, B, C	250	4.3	A, B, C	250	33	F, G, J	250			
0.8	A, B, C	250	4.7	A, B, C	250	36	F, G, J	250			
0.9	A, B, C	250	5.1	A, B, C	250	39	F, G, J	250			
1.0	A, B, C	250	5.6	A, B, C	250	43	F, G, J	250			
1.1	A, B, C	250	6.2	A, B, C	250	47	F, G, J	250			
1.2	A, B, C	250	6.8	B, C, D	250	51	F, G, J	250			
1.3	A, B, C	250	7.5	B, C, D	250	56	F, G, J	250			
1.4	A, B, C	250	8.2	B, C, D	250	62	F, G, J	250			
1.5	A, B, C	250	9.1	B, C, D	250	68	F, G, J	250			
1.6	A, B, C	250	10	F, G, J	250	75	F, G, J	250			
1.7	A, B, C	250	11	F, G, J	250	82	F, G, J	250			
1.8	A, B, C	250	12	F, G, J	250	91	F, G, J	250			
1.9	A, B, C	250	13	F, G, J	250	100	F, G, J	250			
2.0	A, B, C	250	15	F, G, J	250	110	F, G, J	250			
2.2	A, B, C	250	16	F, G, J	250	120	F, G, J	250			

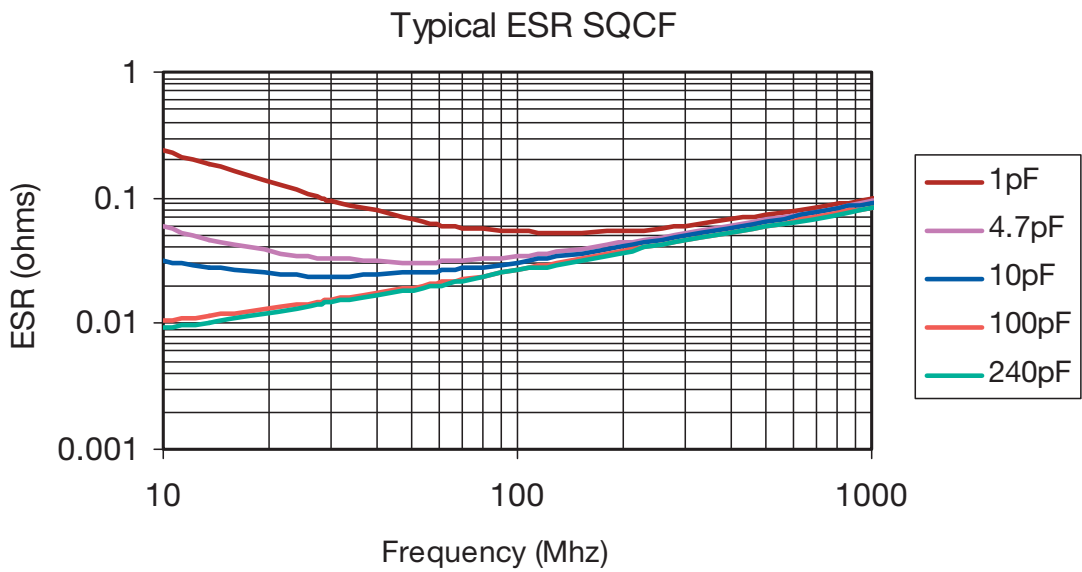
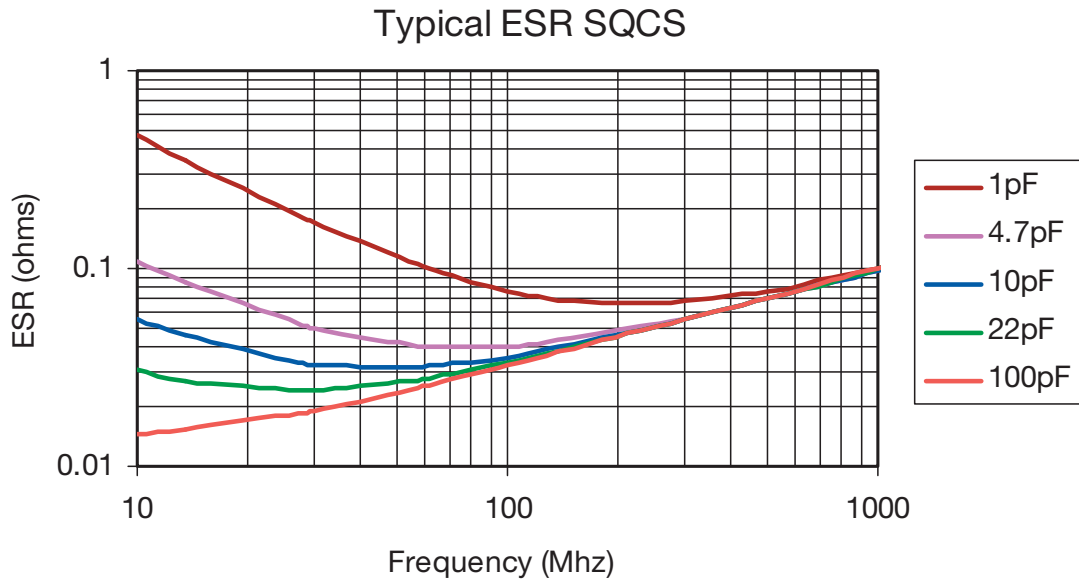

6

Max Current SQCS

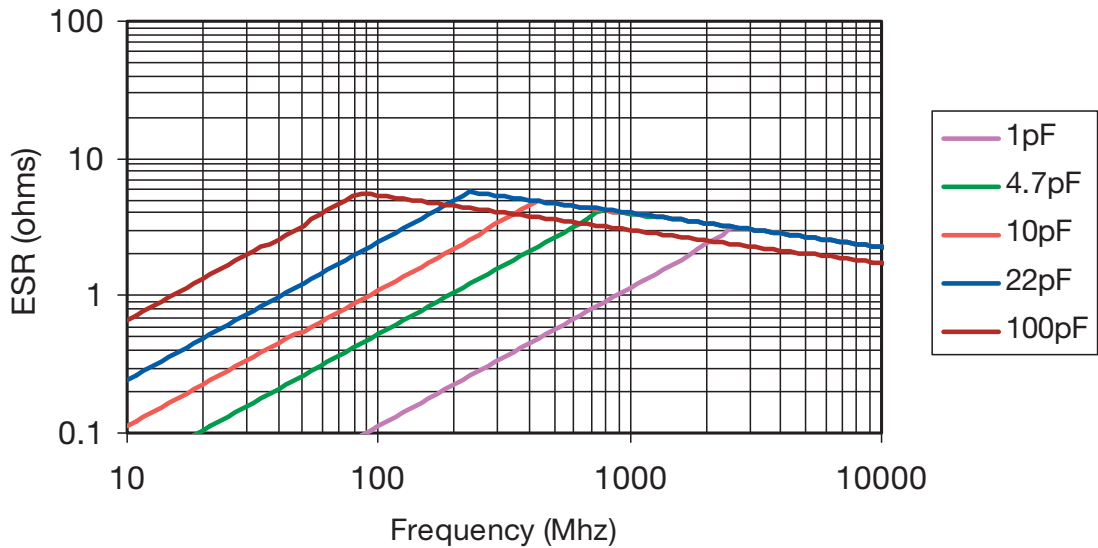

Max Current SQCF

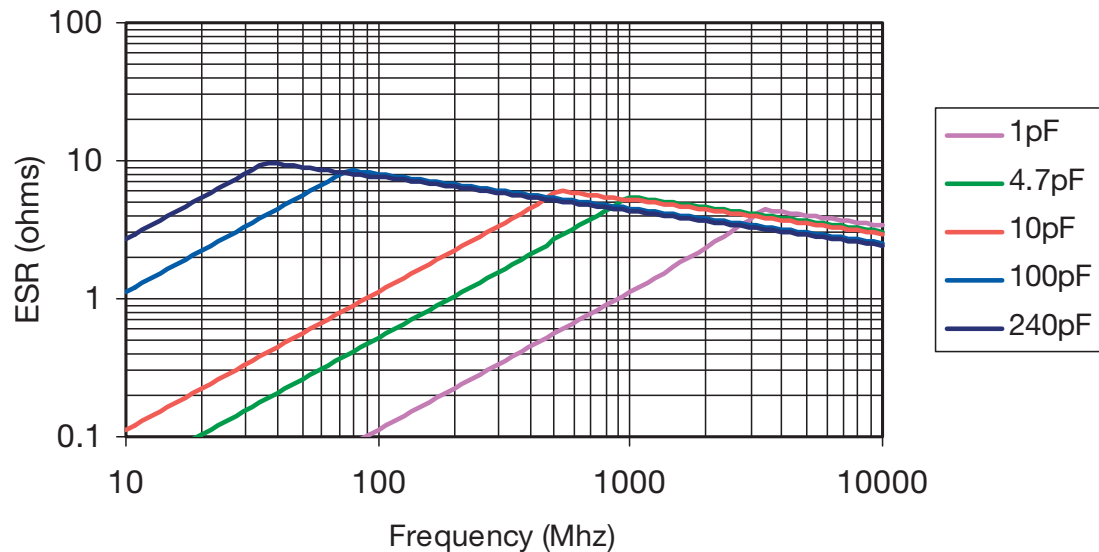

6

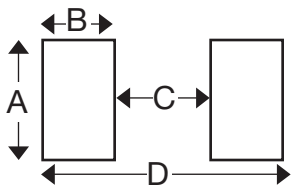
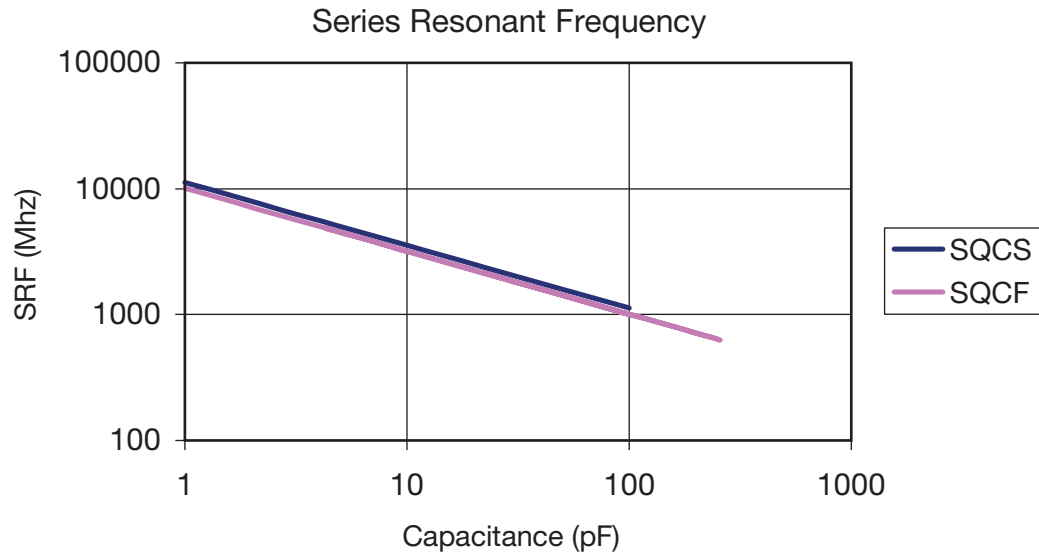

MOUNTING PAD DIMENSIONS: inches (millimeters)

Case	A min	B min	C min	D min
SQCA	0.082 (2.083)	0.051 (1.295)	0.032 (0.813)	0.130 (3.302)
SQCB	0.131 (3.327)	0.051 (1.295)	0.074 (1.880)	0.177 (4.496)
SQCS	0.038 (0.965)	0.043 (1.092)	0.025 (0.635)	0.112 (2.845)
SQCF	0.059 (1.499)	0.051 (1.295)	0.024 (0.610)	0.125 (3.175)

SQCS & SQCF ENGINEERING KITS

PN	Series	Diel	Term	Range	Different Values	# per value
Kit SQ018 T	SQCF	C0G	100% Tin	.1 to 22pF	32	20
Kit SQ019 T			RoHS	10 to 240pF	23	
Kit SQ015 T	SQCS	C0G	100% Tin	.1 to 22pF	32	20
Kit SQ016 T			RoHS	10 to 100pF	16	

Tolerance per PF:	
B from .1 to 3.3	J from 10 to 240
C from 3.9 to 8.2	

Microwave MLC's



AQ Series



These porcelain and ceramic dielectric multilayer capacitor (MLC) chips are best suited for RF/ Microwave applications typically ranging from 10 MHz to 4.2 GHz. Characteristic is a fine grained, high density, high purity dielectric material impervious to moisture with heavy internal palladium electrodes.

These characteristics lend well to applications requiring:

- 1) high current carrying capabilities;
- 2) high quality factors;
- 3) very low equivalent series resistance;
- 4) very high series resonance;
- 5) excellent stability under stresses of changing voltage, frequency, time and temperature.

MECHANICAL DIMENSIONS: inches (millimeters)

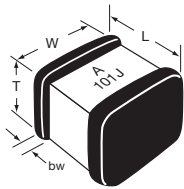

Case	Length (L)	Width (W)	Thickness (T)	Band Width (bw)
AQ11	.055±.015 (1.40±.381)	.055±.015 (1.40±.381)	.020/.057 (.508/1.45)	.010 + .010 - .005 (.254 +.254 -.127)
AQ12	.055 + .015 - .010 (1.40+ .381 - .254)	.055±.015 (1.40±.381)	.020/.057 (.508/1.45)	.010 + .010 - .005 (.254 +.254 -.127)
AQ13	.110±.020 (2.79±.508)	.110±.020 (2.79±.508)	.030/.102 (.762/2.59)	.015±.010 (.381±.254)
AQ14	.110 + .020 - .010 (2.79 +.889 -.254)	.110±.010 (2.79±.508)	.030/.102 (.762/2.59)	.015±.010 (.381±.254)

HOW TO ORDER

<p>AQ</p> <p>AVX Style AQ11, AQ12, AQ13, AQ14</p>	<p>11</p> <p>Case Size (See Chart)</p>	<p>E</p> <p>Voltage Code</p> <p>5 = 50V 1 = 100V E = 150V 2 = 200V 9 = 300V 7 = 500V</p>	<p>M</p> <p>Temperature Coefficient Code</p> <p>M = +90±20ppm/°C (AQ11/12/13/14) A = 0±30ppm/°C (AQ11/12/13/14) C = 15% ("J" Termination only) (AQ12/14)</p>	<p>100</p> <p>Capacitance</p> <p>EIA Capacitance Code in pF. First two digits = significant figures or "R" for decimal place. Third digit = number of zeros or after "R" significant figures.</p>	<p>J</p> <p>Capacitance Tolerance Code</p> <p>B = ±.1 pF C = ±.25 pF D = ±.5 pF F = ±1% G = ±2% J = ±5% K = ±10% M = ±20% N = ±30%</p>	<p>A</p> <p>Failure Rate Code</p> <p>A = Not Applicable</p>	<p>1</p> <p>Termination Style Code</p> <p>1 = Pd/Ag (AQ11/13 only) 7 = Ag/Ni/Au (AQ11/13 only) J = Nickel Barrier Sn/Pb (60/40) - (AQ12/14 only) T = 100% Tin (AQ12/14 only)</p>	<p>ME</p> <p>Packaging* Code</p> <p>3A = 13" Reel ME = 7" Reel RE = 13" Reel WE = Waffle Pack</p>
--	---	---	---	--	---	--	---	--

PACKAGING

Standard Packaging = Waffle Pack (maximum quantity is 80)

TAPE & REEL: All tape and reel specifications are in compliance with EIA RS481 (equivalent to IEC 286 part 3).

Sizes SQCA through SQCB, CDR11/12 through 13/14.

- 8mm carrier
- 7" reel: ≤0.040" thickness = 2000 pcs
 ≤0.075" thickness = 2000 pcs
- 13" reel: ≤0.075" thickness = 10,000 pcs



ELECTRICAL SPECIFICATIONS

AQ11, AQ12, AQ13, AQ14			
		M & A	C
Temperature Coefficient (TCC)		(M) +90 ± 20 PPM/°C (-55°C to +125°C) (M) +90 ± 30 PPM/°C (+125°C to +175°C) (A) 0 ± 30 PPM/°C	±15% (-55°C to 125°C)
Capacitance Range		(M) 0.1 pF to 1000 pF (A) 0.1 pF to 5100 pF	0.001µF to 0.1µF
Operating Temperature		0.1 pF to 330 pF: from -55°C to +175°C 360 pF to 5100 pF: from -55°C to +125°C	-55°C to +125°C
Quality Factor (Q)	M Dielectric A & B Case	Greater than 10,000 at 1 MHz	2.5% @ 1kHz
	A Dielectric B Case	Greater than 10,000 at 1 MHz Greater than 2,000 at 1 MHz Greater than 2,000 at 1 KHz	0.1 - 200 pF 220 - 1000 pF 1100 - 5100 pF
	A Dielectric A Case	Greater than 10,000 at 1 MHz Greater than 2,000 at 1 MHz	0.1 - 100 pF 110 - 1000 pF
Insulation Resistance (IR)		0.1 pF to 470 pF 10 ⁹ Megohms min. @ 25°C at rated WVDC 10 ⁹ Megohms min. @ 125°C at rated WVDC 510 pF to 5100 pF 10 ⁹ Megohms min. @ 25°C at rated WVDC 10 ⁹ Megohms min. @ 125°C at rated WVDC	10 ⁴ Megohms min. @ 25°C at rated WVDC 10 ³ Megohms min. @ 125°C at rated WVDC
Working Voltage (WVDC)		See Capacitance Values table	See Capacitance Values table
Dielectric Withstanding Voltage (DWW)		250% of rated WVDC for 5 secs (for 500V rated 150% of rated voltage)	250% of rated WVDC for 5 secs
Aging Effects		None	<3% per decade hour
Piezoelectric Effects		None	None
Capacitance Drift		± (0.02% or 0.02 pF), whichever is greater	Not Applicable

ENVIRONMENTAL CHARACTERISTICS

AVX SQLB will meet and exceed the requirements of EIA-198, MIL-PRF-55681 and MIL-PRF-123

Thermal Shock	Mil-STD-202, Method 107, Condition A
Moisture Resistance	Mil-STD-202, Method 106
Low Voltage Humidity	Mil-STD-202, Method 103, condition A, with 1.5 VDC applied while subjected to an environment of 85°C with 85% relative humidity for 240 hours
Life Test	Mil-STD-202, Method 108, for 2000 hours at 125°C
Shock	Mil-STD-202, Method 213, Condition J
Vibration	Mil-STD-202, Method 204, Condition B
Immersion	Mil-STD-202, Method 104, Condition B
Salt Spray	Mil-STD-202, Method 101, Condition B
Solderability	Mil-STD-202, Method 208
Terminal Strength	Mil-STD-202, Method 211
Temperature Cycling	Mil-STD-202, Method 102, Condition C
Barometric Pressure	Mil-STD-202, Method 105, Condition B
Resistance to Solder Heat	Mil-STD-202, Method 210, Condition C

Microwave MLC's



AQ Series Available Capacitance/Size/WVDC/T.C.

**TABLE I: TC: M (+90±20PPM/°C)
CASE SIZE 11, 12, 13 & 14**

DIMENSIONS: inches (millimeters)

Case	Length	Width	Thickness	Band Width	Avail. Term.
11	.055±.015 (1.40±.381)	.055±.015 (1.40±.381)	.020/.057 (.508/1.45)	.010 +.010 -.005 (.254 +.254 -.127)	1 & 7
12	.055±.025 (1.40±.635)	.055±.015 (1.40±.381)	.020/.057 (.508/1.45)	.010 +.010 -.005 (.254 +.254 -.127)	J
13	.110±.020 (2.79±.508)	.110±.020 (2.79±.508)	.030/.102 (.762/2.59)	.015±.010 (.381±.254)	1 & 7
14	.110 +0.035 -0.020 (2.79 +.889 -.508)	.110±.020 (2.79±.508)	.030/.102 (.762/2.59)	.015±.010 (.381±.254)	J

Case: AQ11, AQ12		
Cap. pF	Cap. Tol.	WVDC
0.1	B	150
0.2	B	150
0.3	B,C	150
0.4	B,C	150
0.5	B, C, D	150
0.6	B, C, D	150
0.7	B, C, D	150
0.8	B, C, D	150
0.9	B, C, D	150
1.0	B, C, D	150
1.1	B, C, D	150
1.2	B, C, D	150
1.3	B, C, D	150
1.4	B, C, D	150
1.5	B, C, D	150
1.6	B, C, D	150
1.7	B, C, D	150
1.8	B, C, D	150
1.9	B, C, D	150
2.0	B, C, D	150
2.2	B, C, D	150
2.4	B, C, D	150
2.7	B, C, D	150
3.0	B, C, D	150
3.3	B, C, D	150
3.6	B, C, D	150
3.9	B, C, D	150
4.3	B, C, D	150
4.7	B, C, D	150
5.1	B, C, D	150
5.6	B, C, D	150
6.2	B, C, D	150
6.8	B, C, J, K, M	150
7.5	B, C, J, K, M	150
8.2	B, C, J, K, M	150
9.1	B, C, J, K, M	150
10	F, G, J, K, M	150
11	F, G, J, K, M	150
12	F, G, J, K, M	150
13	F, G, J, K, M	150
15	F, G, J, K, M	150
16	F, G, J, K, M	150
18	F, G, J, K, M	150
20	F, G, J, K, M	150
22	F, G, J, K, M	150
24	F, G, J, K, M	150
27	F, G, J, K, M	150
30	F, G, J, K, M	150
33	F, G, J, K, M	150
36	F, G, J, K, M	150
39	F, G, J, K, M	150
43	F, G, J, K, M	150
47	F, G, J, K, M	150
51	F, G, J, K, M	150
56	F, G, J, K, M	150
62	F, G, J, K, M	150
68	F, G, J, K, M	150
75	F, G, J, K, M	150
82	F, G, J, K, M	150
91	F, G, J, K, M	150
100	F, G, J, K, M	150

Case: AQ13, AQ14		
Cap. pF	Cap. Tol.	WVDC
0.1	B	500
0.2	B	500
0.3	B,C	500
0.4	B,C	500
0.5	B, C, D	500
0.6	B, C, D	500
0.7	B, C, D	500
0.8	B, C, D	500
0.9	B, C, D	500
1.0	B, C, D	500
1.1	B, C, D	500
1.2	B, C, D	500
1.3	B, C, D	500
1.4	B, C, D	500
1.5	B, C, D	500
1.6	B, C, D	500
1.7	B, C, D	500
1.8	B, C, D	500
1.9	B, C, D	500
2.0	B, C, D	500
2.2	B, C, D	500
2.4	B, C, D	500
2.7	B, C, D	500
3.0	B, C, D	500
3.3	B, C, D	500
3.6	B, C, D	500
3.9	B, C, D	500
4.3	B, C, D	500
4.7	B, C, D	500
5.1	B, C, D	500
5.6	B, C, D	500
6.2	B, C, D	500
6.8	B, C, J, K, M	500
7.5	B, C, J, K, M	500
8.2	B, C, J, K, M	500
9.1	B, C, J, K, M	500
10	F, G, J, K, M	500
11	F, G, J, K, M	500
12	F, G, J, K, M	500
13	F, G, J, K, M	500
15	F, G, J, K, M	500
16	F, G, J, K, M	500
18	F, G, J, K, M	500
20	F, G, J, K, M	500
22	F, G, J, K, M	500
24	F, G, J, K, M	500
27	F, G, J, K, M	500
30	F, G, J, K, M	500
33	F, G, J, K, M	500
36	F, G, J, K, M	500
39	F, G, J, K, M	500
43	F, G, J, K, M	500
47	F, G, J, K, M	500
51	F, G, J, K, M	500
56	F, G, J, K, M	500
62	F, G, J, K, M	500
68	F, G, J, K, M	500
75	F, G, J, K, M	500
82	F, G, J, K, M	500
91	F, G, J, K, M	500

Cap. pF	Cap. Tol.	WVDC
100	F, G, J, K, M	500
110	F, G, J, K, M	300
120	F, G, J, K, M	300
130	F, G, J, K, M	300
150	F, G, J, K, M	300
160	F, G, J, K, M	300
180	F, G, J, K, M	300
200	F, G, J, K, M	300
220	F, G, J, K, M	200
240	F, G, J, K, M	200
270	F, G, J, K, M	200
300	F, G, J, K, M	200
330	F, G, J, K, M	200
360	F, G, J, K, M	200
390	F, G, J, K, M	200
430	F, G, J, K, M	200
470	F, G, J, K, M	200
510	F, G, J, K, M	150
560	F, G, J, K, M	150
620	F, G, J, K, M	150
680	F, G, J, K, M	150
750	F, G, J, K, M	150
820	F, G, J, K, M	150
910	F, G, J, K, M	150
1000	F, G, J, K, M	150



Microwave MLC's



AQ Series Available Capacitance/Size/WVDC/T.C.

TABLE II: TC: A (0±30PPM/°C)
CASE SIZE 11, 12, 13 & 14

DIMENSIONS: inches (millimeters)

Case	Length	Width	Thickness	Band Width	Avail. Term.
11	.055±.015 (1.40±.381)	.055±.015 (1.40±.381)	.020/.057 (.508/1.45)	.010 +.010 -.005 (.254 +.254 -.127)	1 & 7
12	.055±.025 (1.40±.635)	.055±.015 (1.40±.381)	.020/.057 (.508/1.45)	.010 +.010 -.005 (.254 +.254 -.127)	J
13	.110±.020 (2.79±.508)	.110±.020 (2.79±.508)	.030/.102 (.762/2.59)	.015±.010 (.381±.254)	1 & 7
14	.110 +0.035 -0.020 (2.79 +.889 -.508)	.110±.020 (2.79±.508)	.030/.102 (.762/2.59)	.015±.010 (.381±.254)	J

Case: AQ11, AQ12					
Cap. pF	Cap. Tol.	WVDC	Cap. pF	Cap. Tol.	WVDC
0.1	B	150	24	F, G, J, K, M	150
0.2	B	150	27	F, G, J, K, M	150
0.3	B,C	150	30	F, G, J, K, M	150
0.4	B,C	150	33	F, G, J, K, M	150
0.5	B, C, D	150	36	F, G, J, K, M	150
0.6	B, C, D	150	39	F, G, J, K, M	150
0.7	B, C, D	150	43	F, G, J, K, M	150
0.8	B, C, D	150	47	F, G, J, K, M	150
0.9	B, C, D	150	51	F, G, J, K, M	150
1.0	B, C, D	150	56	F, G, J, K, M	150
1.1	B, C, D	150	62	F, G, J, K, M	150
1.2	B, C, D	150	68	F, G, J, K, M	150
1.3	B, C, D	150	75	F, G, J, K, M	150
1.4	B, C, D	150	82	F, G, J, K, M	150
1.5	B, C, D	150	91	F, G, J, K, M	150
1.6	B, C, D	150	100	F, G, J, K, M	150
1.7	B, C, D	150	110	F, G, J, K, M	50
1.8	B, C, D	150	120	F, G, J, K, M	50
1.9	B, C, D	150	130	F, G, J, K, M	50
2.0	B, C, D	150	150	F, G, J, K, M	50
2.2	B, C, D	150	160	F, G, J, K, M	50
2.4	B, C, D	150	180	F, G, J, K, M	50
2.7	B, C, D	150	200	F, G, J, K, M	50
3.0	B, C, D	150	220	F, G, J, K, M	50
3.3	B, C, D	150	240	F, G, J, K, M	50
3.6	B, C, D	150	270	F, G, J, K, M	50
3.9	B, C, D	150	300	F, G, J, K, M	50
4.3	B, C, D	150	330	F, G, J, K, M	50
4.7	B, C, D	150	360	F, G, J, K, M	50
5.1	B, C, D	150	390	F, G, J, K, M	50
5.6	B, C, D	150	430	F, G, J, K, M	50
6.2	B, C, D	150	470	F, G, J, K, M	50
6.8	B, C, J, K, M	150	510	F, G, J, K, M	50
7.5	B, C, J, K, M	150	560	F, G, J, K, M	50
8.2	B, C, J, K, M	150	620	F, G, J, K, M	50
9.1	B, C, J, K, M	150	680	F, G, J, K, M	50
10	F, G, J, K, M	150	750	F, G, J, K, M	50
11	F, G, J, K, M	150	820	F, G, J, K, M	50
12	F, G, J, K, M	150	910	F, G, J, K, M	50
13	F, G, J, K, M	150	1000	F, G, J, K, M	50
15	F, G, J, K, M	150			
16	F, G, J, K, M	150			
18	F, G, J, K, M	150			
20	F, G, J, K, M	150			
22	F, G, J, K, M	150			

Case: AQ13, AQ14					
Cap. pF	Cap. Tol.	WVDC	Cap. pF	Cap. Tol.	WVDC
0.1	B	500	51	F, G, J, K, M	500
0.2	B	500	56	F, G, J, K, M	500
0.3	B,C	500	62	F, G, J, K, M	500
0.4	B,C	500	68	F, G, J, K, M	500
0.5	B, C, D	500	75	F, G, J, K, M	500
0.6	B, C, D	500	82	F, G, J, K, M	500
0.7	B, C, D	500	91	F, G, J, K, M	500
0.8	B, C, D	500	100	F, G, J, K, M	500
0.9	B, C, D	500	110	F, G, J, K, M	300
1.0	B, C, D	500	120	F, G, J, K, M	300
1.1	B, C, D	500	130	F, G, J, K, M	300
1.2	B, C, D	500	150	F, G, J, K, M	300
1.3	B, C, D	500	160	F, G, J, K, M	300
1.4	B, C, D	500	180	F, G, J, K, M	300
1.5	B, C, D	500	200	F, G, J, K, M	300
1.6	B, C, D	500	220	F, G, J, K, M	200
1.7	B, C, D	500	240	F, G, J, K, M	200
1.8	B, C, D	500	270	F, G, J, K, M	200
1.9	B, C, D	500	300	F, G, J, K, M	200
2.0	B, C, D	500	330	F, G, J, K, M	200
2.2	B, C, D	500	360	F, G, J, K, M	200
2.4	B, C, D	500	390	F, G, J, K, M	200
2.7	B, C, D	500	430	F, G, J, K, M	200
3.0	B, C, D	500	470	F, G, J, K, M	200
3.3	B, C, D	500	510	F, G, J, K, M	150
3.6	B, C, D	500	560	F, G, J, K, M	150
3.9	B, C, D	500	620	F, G, J, K, M	150
4.3	B, C, D	500	680	F, G, J, K, M	150
4.7	B, C, D	500	750	F, G, J, K, M	150
5.1	B, C, D	500	820	F, G, J, K, M	150
5.6	B, C, D	500	910	F, G, J, K, M	150
6.2	B, C, D	500	1000	F, G, J, K, M	150
6.8	B, C, J, K, M	500	1100	F, G, J, K, M	50
7.5	B, C, J, K, M	500	1200	F, G, J, K, M	50
8.2	B, C, J, K, M	500	1300	F, G, J, K, M	50
9.1	B, C, J, K, M	500	1500	F, G, J, K, M	50
10	F, G, J, K, M	500	1600	F, G, J, K, M	50
11	F, G, J, K, M	500	1800	F, G, J, K, M	50
12	F, G, J, K, M	500	2000	F, G, J, K, M	50
13	F, G, J, K, M	500	2200	F, G, J, K, M	50
15	F, G, J, K, M	500	2400	F, G, J, K, M	50
16	F, G, J, K, M	500	2700	F, G, J, K, M	50
18	F, G, J, K, M	500	3000	F, G, J, K, M	50
20	F, G, J, K, M	500	3300	F, G, J, K, M	50
22	F, G, J, K, M	500	3600	F, G, J, K, M	50
24	F, G, J, K, M	500	3900	F, G, J, K, M	50
27	F, G, J, K, M	500	4300	F, G, J, K, M	50
30	F, G, J, K, M	500	4700	F, G, J, K, M	50
33	F, G, J, K, M	500	5000	F, G, J, K, M	50
36	F, G, J, K, M	500	5100	F, G, J, K, M	50
39	F, G, J, K, M	500			
43	F, G, J, K, M	500			
47	F, G, J, K, M	500			

TABLE III: TC: C (±15%) CASE SIZE 12 & 14

Case: AQ12									Case: AQ14								
Cap. pF	Cap. Tol.	WVDC	Cap. pF	Cap. Tol.	WVDC	Cap. pF	Cap. Tol.	WVDC	Cap. pF	Cap. Tol.	WVDC	Cap. pF	Cap. Tol.	WVDC	Cap. pF	Cap. Tol.	WVDC
1000	K, M, N	50	2200	K, M, N	50	5100	K, M, N	50	5000	K, M, N	50	15000	K, M, N	50	47000	K, M, N	50
1200	K, M, N	50	2700	K, M, N	50	5600	K, M, N	50	6800	K, M, N	50	18000	K, M, N	50	68000	K, M, N	50
1500	K, M, N	50	3300	K, M, N	50	6800	K, M, N	50	8200	K, M, N	50	27000	K, M, N	50	82000	K, M, N	50
1800	K, M, N	50	3900	K, M, N	50	8200	K, M, N	50	10000	K, M, N	50	33000	K, M, N	50	100000	K, M, N	50
2000	K, M, N	50	4700	K, M, N	50	10000	K, M, N	50	12000	K, M, N	50	39000	K, M, N	50			



Microwave MLC's



CDR Series — MIL-PRF-55681 (RF/Microwave Chips)

MILITARY DESIGNATION PER MIL-PRF-55681

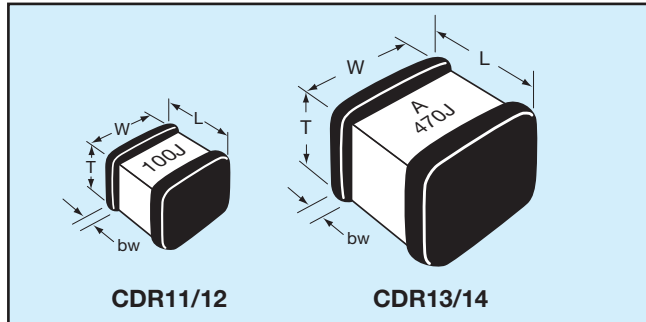

CROSS REFERENCE: AVX/MIL-PRF-55681

Per MIL-C-55681	AVX Style	Length (L)	Width (W)	Thickness (T)		Termination Band (bw)	
				Max	Min	Max	Min
CDR11	AQ11	.055±.015 (1.40±.381)	.055±.015 (1.40±.381)	.057 (1.45)	.020 (.508)	.020 (.508)	.005 (.127)
CDR12	AQ12	.055±.025 (1.40±.635)	.055±.015 (1.40±.381)	.057 (1.45)	.020 (.508)	.020 (.508)	.005 (.127)
CDR13	AQ13	.110±.020 (2.79±.508)	.110±.020 (2.79±.508)	.102 (2.59)	.030 (.762)	.025 (.635)	.005 (.127)
CDR14	AQ14	.110 +.035 -0.20 (2.79 +.889 -.508)	.110±.020 (2.79±.508)	.102 (2.59)	.030 (.762)	.025 (.635)	.005 (.127)

HOW TO ORDER

CDR12

MIL Style
CDR11, CDR12,
CDR13, CDR14

BG

Voltage Temperature Limits

BG = +90±20 ppm/°C with and without rated voltage from -55°C to + 125°C
BP = 0±30ppm/°C with and without rated voltage from -55°C to +125°C

101

Capacitance

EIA Capacitance Code in pF.
First two digits = significant figures or "R" for decimal place.
Third digit = number of zeros or after "R" significant figures.

A

Rated Voltage Code

A = 50V
B = 100V
C = 200V
D = 300V
E = 500V

K

Capacitance Tolerance Code

B = ±.1 pF
C = ±.25 pF
D = ±.5 pF
F = ±1%
G = ±2%
J = ±5%
K = ±10%
M = ±20%

U

Termination Finish (Military Designations) Code

M = Palladium/Silver (CDR11 & 13 only)
N = Silver, Nickel, Gold (CDR11 & 13 only)
S = Solder Coated, Final (CDR12 & 14 only)
U = Base Metallization, Barrier Metal, Solder Coated. (Solder M.P. 200°C or less) (CDR12 & 14 only)
W = Base Metallization, Barrier Metal, Tinned (Tin or Tin/Lead Alloy) (CDR12 & 14 only)
Y = 100% Tin
Z = Base Metallization, Barrier Metal (Tin Lead Alloy With 4% Lead Min.)

S

Failure Rate Level

M = 1.0%
P = .1%
R = .01%
S = .001%

6

PACKAGING

Standard Packaging Quantity

CDR11-12 = 100 pcs per waffle pack

CDR13-14 = 80 pcs per waffle pack

TAPE & REEL: All tape and reel specifications are in compliance with EIA RS481 (equivalent to IEC 286 part 3).

Sizes SQCA through SQCB, CDR11/12 through 13/14.

—8mm carrier

—7" reel: ≤0.040" thickness = 2000 pcs

≤0.075" thickness = 2000 pcs

—13" reel: ≤0.075" thickness = 10,000 pcs

TABLE I: STYLES CDR11 AND CDR12 CAPACITOR CHARACTERISTICS

Type Designation 1/	Capacitance in pF	Capacitance tolerance	Rated temperature and V/Temperature	WVDC	Type Designation 1/	Capacitance in pF	Capacitance tolerance	Rated temperature and V/Temperature	WVDC
CDR1 -B-0R1AB--	0.1	B	BG, BP	50	CDR1 -B-300A--	30	F, G, J, K, M	BG, BP	50
CDR1 -B-0R2AB--	0.2	B	BG, BP	50	CDR1 -B-330A--	33	F, G, J, K, M	BG, BP	50
CDR1 -B-0R3A--	0.3	B, C	BG, BP	50	CDR1 -B-360A--	36	F, G, J, K, M	BG, BP	50
CDR1 -B-0R4A--	0.4	B, C	BG, BP	50	CDR1 -B-390A--	39	F, G, J, K, M	BG, BP	50
CDR1 -B-0R5A--	0.5	B, C, D	BG, BP	50	CDR1 -B-430A--	43	F, G, J, K, M	BG, BP	50
CDR1 -B-0R6A--	0.6	B, C, D	BG, BP	50	CDR1 -B-470A--	47	F, G, J, K, M	BG, BP	50
CDR1 -B-0R7A--	0.7	B, C, D	BG, BP	50	CDR1 -B-510A--	51	F, G, J, K, M	BG, BP	50
CDR1 -B-0R8A--	0.8	B, C, D	BG, BP	50	CDR1 -B-560A--	56	F, G, J, K, M	BG, BP	50
CDR1 -B-0R9A--	0.9	B, C, D	BG, BP	50	CDR1 -B-620A--	62	F, G, J, K, M	BG, BP	50
CDR1 -B-1R0A--	1.0	B, C, D	BG, BP	50	CDR1 -B-680A--	68	F, G, J, K, M	BG, BP	50
CDR1 -B-1R1A--	1.1	B, C, D	BG, BP	50	CDR1 -B-750A--	75	F, G, J, K, M	BG, BP	50
CDR1 -B-1R2A--	1.2	B, C, D	BG, BP	50	CDR1 -B-820A--	82	F, G, J, K, M	BG, BP	50
CDR1 -B-1R3A--	1.3	B, C, D	BG, BP	50	CDR1 -B-910A--	91	F, G, J, K, M	BG, BP	50
CDR1 -B-1R4A--	1.4	B, C, D	BG, BP	50	CDR1 -B-101A--	100	F, G, J, K, M	BG, BP	50
CDR1 -B-1R5A--	1.5	B, C, D	BG, BP	50	CDR1 -B-111A--	110	F, G, J, K, M	BP	50
CDR1 -B-1R6A--	1.6	B, C, D	BG, BP	50	CDR1 -B-121A--	120	F, G, J, K, M	BP	50
CDR1 -B-1R7A--	1.7	B, C, D	BG, BP	50	CDR1 -B-131A--	130	F, G, J, K, M	BP	50
CDR1 -B-1R8A--	1.8	B, C, D	BG, BP	50	CDR1 -B-151A--	150	F, G, J, K, M	BP	50
CDR1 -B-1R9A--	1.9	B, C, D	BG, BP	50	CDR1 -B-161A--	160	F, G, J, K, M	BP	50
CDR1 -B-2R0A--	2.0	B, C, D	BG, BP	50	CDR1 -B-181A--	180	F, G, J, K, M	BP	50
CDR1 -B-2R1A--	2.1	B, C, D	BG, BP	50	CDR1 -B-201A--	200	F, G, J, K, M	BP	50
CDR1 -B-2R2A--	2.2	B, C, D	BG, BP	50	CDR1 -B-221A--	220	F, G, J, K, M	BP	50
CDR1 -B-2R4A--	2.4	B, C, D	BG, BP	50	CDR1 -B-241A--	240	F, G, J, K, M	BP	50
CDR1 -B-2R7A--	2.7	B, C, D	BG, BP	50	CDR1 -B-271A--	270	F, G, J, K, M	BP	50
CDR1 -B-3R0A--	3.0	B, C, D	BG, BP	50	CDR1 -B-301A--	300	F, G, J, K, M	BP	50
CDR1 -B-3R3A--	3.3	B, C, D	BG, BP	50	CDR1 -B-331A--	330	F, G, J, K, M	BP	50
CDR1 -B-3R6A--	3.6	B, C, D	BG, BP	50	CDR1 -B-361A--	360	F, G, J, K, M	BP	50
CDR1 -B-3R9A--	3.9	B, C, D	BG, BP	50	CDR1 -B-391A--	390	F, G, J, K, M	BP	50
CDR1 -B-4R3A--	4.3	B, C, D	BG, BP	50	CDR1 -B-431A--	430	F, G, J, K, M	BP	50
CDR1 -B-4R7A--	4.7	B, C, D	BG, BP	50	CDR1 -B-471A--	470	F, G, J, K, M	BP	50
CDR1 -B-5R1A--	5.1	B, C, D	BG, BP	50	CDR1 -B-511A--	510	F, G, J, K, M	BP	50
CDR1 -B-5R6A--	5.6	B, C, D	BG, BP	50	CDR1 -B-561A--	560	F, G, J, K, M	BP	50
CDR1 -B-6R2A--	6.2	B, C, D	BG, BP	50	CDR1 -B-621A--	620	F, G, J, K, M	BP	50
CDR1 -B-6R8A--	6.8	B, C, J, K, M	BG, BP	50	CDR1 -B-681A--	680	F, G, J, K, M	BP	50
CDR1 -B-7R5A--	7.5	B, C, J, K, M	BG, BP	50	CDR1 -B-751A--	750	F, G, J, K, M	BP	50
CDR1 -B-8R2A--	8.2	B, C, J, K, M	BG, BP	50	CDR1 -B-821A--	820	F, G, J, K, M	BP	50
CDR1 -B-9R1A--	9.1	B, C, J, K, M	BG, BP	50	CDR1 -B-911A--	910	F, G, J, K, M	BP	50
CDR1 -B-100A--	10	F, G, J, K, M	BG, BP	50	CDR1 -B-102A--	1000	F, G, J, K, M	BP	50
CDR1 -B-110A--	11	F, G, J, K, M	BG, BP	50					
CDR1 -B-120A--	12	F, G, J, K, M	BG, BP	50					
CDR1 -B-130A--	13	F, G, J, K, M	BG, BP	50					
CDR1 -B-150A--	15	F, G, J, K, M	BG, BP	50					
CDR1 -B-160A--	16	F, G, J, K, M	BG, BP	50					
CDR1 -B-180A--	18	F, G, J, K, M	BG, BP	50					
CDR1 -B-200A--	20	F, G, J, K, M	BG, BP	50					
CDR1 -B-220A--	22	F, G, J, K, M	BG, BP	50					
CDR1 -B-240A--	24	F, G, J, K, M	BG, BP	50					
CDR1 -B-270A--	27	F, G, J, K, M	BG, BP	50					

1/Complete type designation will include additional symbols to indicate style, voltage-temperature limits, capacitance tolerance (where applicable), termination finish ("M" or "N" for style CDR11, and "S", "U" or "W" for style CDR12) and failure rate level.

Microwave MLC's

CDR Series — MIL-PRF-55681 (RF/Microwave Chips)



TABLE II: STYLES CDR13 AND CDR14 CAPACITOR CHARACTERISTICS

Type Designation 1/	Capacitance in pF	Capacitance tolerance	Rated temperature and V/Temperature	WVDC	Type Designation 1/	Capacitance in pF	Capacitance tolerance	Rated temperature and V/Temperature	WVDC
CDR1 -B-0R1*B--	0.1	B	BG, BP	200/500	CDR1 -B-560*---	56	F, G, J, K, M	BG, BP	200/500
CDR1 -B-0R2*B--	0.2	B	BG, BP	200/500	CDR1 -B-620*---	62	F, G, J, K, M	BG, BP	200/500
CDR1 -B-0R3*---	0.3	B, C	BG, BP	200/500	CDR1 -B-680*---	68	F, G, J, K, M	BG, BP	200/500
CDR1 -B-0R4*---	0.4	B, C	BG, BP	200/500	CDR1 -B-750*---	75	F, G, J, K, M	BG, BP	200/500
CDR1 -B-0R5*---	0.5	B, C, D	BG, BP	200/500	CDR1 -B-820*---	82	F, G, J, K, M	BG, BP	200/500
CDR1 -B-0R6*---	0.6	B, C, D	BG, BP	200/500	CDR1 -B-910*---	91	F, G, J, K, M	BG, BP	200/500
CDR1 -B-0R7*---	0.7	B, C, D	BG, BP	200/500	CDR1 -B-101*---	100	F, G, J, K, M	BG, BP	200/500
CDR1 -B-0R8*---	0.8	B, C, D	BG, BP	200/500	CDR1 -B-111*---	110	F, G, J, K, M	BG, BP	200/300
CDR1 -B-0R9*---	0.9	B, C, D	BG, BP	200/500	CDR1 -B-121*---	120	F, G, J, K, M	BG, BP	200/300
CDR1 -B-1R0*---	1.0	B, C, D	BG, BP	200/500	CDR1 -B-131*---	130	F, G, J, K, M	BG, BP	200/300
CDR1 -B-1R1*---	1.1	B, C, D	BG, BP	200/500	CDR1 -B-151*---	150	F, G, J, K, M	BG, BP	200/300
CDR1 -B-1R2*---	1.2	B, C, D	BG, BP	200/500	CDR1 -B-161*---	160	F, G, J, K, M	BG, BP	200/300
CDR1 -B-1R3*---	1.3	B, C, D	BG, BP	200/500	CDR1 -B-181*---	180	F, G, J, K, M	BG, BP	200/300
CDR1 -B-1R4*---	1.4	B, C, D	BG, BP	200/500	CDR1 -B-201*---	200	F, G, J, K, M	BG, BP	200/300
CDR1 -B-1R5*---	1.5	B, C, D	BG, BP	200/500	CDR1 -B-221C---	220	F, G, J, K, M	BG, BP	200
CDR1 -B-1R6*---	1.6	B, C, D	BG, BP	200/500	CDR1 -B-241C---	240	F, G, J, K, M	BG, BP	200
CDR1 -B-1R7*---	1.7	B, C, D	BG, BP	200/500	CDR1 -B-271C---	270	F, G, J, K, M	BG, BP	200
CDR1 -B-1R8*---	1.8	B, C, D	BG, BP	200/500	CDR1 -B-301C---	300	F, G, J, K, M	BG, BP	200
CDR1 -B-1R9*---	1.9	B, C, D	BG, BP	200/500	CDR1 -B-331C---	330	F, G, J, K, M	BG, BP	200
CDR1 -B-2R0*---	2.0	B, C, D	BG, BP	200/500	CDR1 -B-361C---	360	F, G, J, K, M	BG, BP	200
CDR1 -B-2R1*---	2.1	B, C, D	BG, BP	200/500	CDR1 -B-391C---	390	F, G, J, K, M	BG, BP	200
CDR1 -B-2R2*---	2.2	B, C, D	BG, BP	200/500	CDR1 -B-431C---	430	F, G, J, K, M	BG, BP	200
CDR1 -B-2R4*---	2.4	B, C, D	BG, BP	200/500	CDR1 -B-471C---	470	F, G, J, K, M	BG, BP	200
CDR1 -B-2R7*---	2.7	B, C, D	BG, BP	200/500	CDR1 -B-511B---	510	F, G, J, K, M	BG, BP	100
CDR1 -B-3R0*---	3.0	B, C, D	BG, BP	200/500	CDR1 -B-561B---	560	F, G, J, K, M	BG, BP	100
CDR1 -B-3R3*---	3.3	B, C, D	BG, BP	200/500	CDR1 -B-621B---	620	F, G, J, K, M	BG, BP	100
CDR1 -B-3R6*---	3.6	B, C, D	BG, BP	200/500	CDR1 -B-681A---	680	F, G, J, K, M	BG, BP	50
CDR1 -B-3R9*---	3.9	B, C, D	BG, BP	200/500	CDR1 -B-751A---	750	F, G, J, K, M	BG, BP	50
CDR1 -B-4R3*---	4.3	B, C, D	BG, BP	200/500	CDR1 -B-821A---	820	F, G, J, K, M	BG, BP	50
CDR1 -B-4R7*---	4.7	B, C, D	BG, BP	200/500	CDR1 -B-911A---	910	F, G, J, K, M	BG, BP	50
CDR1 -B-5R1*---	5.1	B, C, D	BG, BP	200/500	CDR1 -B-102A---	1000	F, G, J, K, M	BG, BP	50
CDR1 -B-5R6*---	5.6	B, C, D	BG, BP	200/500	CDR1 -B-112A---	1100	F, G, J, K, M	BP	50
CDR1 -B-6R2*---	6.2	B, C, D	BG, BP	200/500	CDR1 -B-122A---	1200	F, G, J, K, M	BP	50
CDR1 -B-6R8*---	6.8	B, C, J, K, M	BG, BP	200/500	CDR1 -B-132A---	1300	F, G, J, K, M	BP	50
CDR1 -B-7R5*---	7.5	B, C, J, K, M	BG, BP	200/500	CDR1 -B-152A---	1500	F, G, J, K, M	BP	50
CDR1 -B-8R2*---	8.2	B, C, J, K, M	BG, BP	200/500	CDR1 -B-162A---	1600	F, G, J, K, M	BP	50
CDR1 -B-9R1*---	9.1	B, C, J, K, M	BG, BP	200/500	CDR1 -B-182A---	1800	F, G, J, K, M	BP	50
CDR1 -B-100*---	10	F, G, J, K, M	BG, BP	200/500	CDR1 -B-202A---	2000	F, G, J, K, M	BP	50
CDR1 -B-110*---	11	F, G, J, K, M	BG, BP	200/500	CDR1 -B-222A---	2200	F, G, J, K, M	BP	50
CDR1 -B-120*---	12	F, G, J, K, M	BG, BP	200/500	CDR1 -B-242A---	2400	F, G, J, K, M	BP	50
CDR1 -B-130*---	13	F, G, J, K, M	BG, BP	200/500	CDR1 -B-272A---	2700	F, G, J, K, M	BP	50
CDR1 -B-150*---	15	F, G, J, K, M	BG, BP	200/500	CDR1 -B-302A---	3000	F, G, J, K, M	BP	50
CDR1 -B-160*---	16	F, G, J, K, M	BG, BP	200/500	CDR1 -B-332A---	3300	F, G, J, K, M	BP	50
CDR1 -B-180*---	18	F, G, J, K, M	BG, BP	200/500	CDR1 -B-362A---	3600	F, G, J, K, M	BP	50
CDR1 -B-200*---	20	F, G, J, K, M	BG, BP	200/500	CDR1 -B-392A---	3900	F, G, J, K, M	BP	50
CDR1 -B-220*---	22	F, G, J, K, M	BG, BP	200/500	CDR1 -B-432A---	4300	F, G, J, K, M	BP	50
CDR1 -B-240*---	24	F, G, J, K, M	BG, BP	200/500	CDR1 -B-472A---	4700	F, G, J, K, M	BP	50
CDR1 -B-270*---	27	F, G, J, K, M	BG, BP	200/500	CDR1 -B-502A---	5000	F, G, J, K, M	BP	50
CDR1 -B-300*---	30	F, G, J, K, M	BG, BP	200/500	CDR1 -B-512A---	5100	F, G, J, K, M	BP	50
CDR1 -B-330*---	33	F, G, J, K, M	BG, BP	200/500					
CDR1 -B-360*---	36	F, G, J, K, M	BG, BP	200/500					
CDR1 -B-390*---	39	F, G, J, K, M	BG, BP	200/500					
CDR1 -B-430*---	43	F, G, J, K, M	BG, BP	200/500					
CDR1 -B-470*---	47	F, G, J, K, M	BG, BP	200/500					
CDR1 -B-510*---	51	F, G, J, K, M	BG, BP	200/500					

1/Complete type designation will include additional symbols to indicate style, voltage-temperature limits, capacitance tolerance (where applicable), termination finish ("M" or "N" for style CDR13, and "S", "U" or "W" for style CDR14) and failure rate level.

*C=200V; E=500V.

‡C=200V; D=300V.



TYPICAL Q vs. FREQUENCY
 AQ11/12
 MIL-PRF-55681E - BG
 STANDARD - M

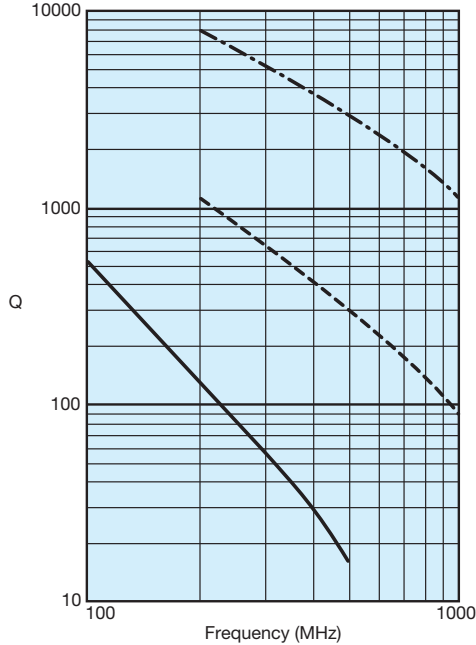

AVX CORPORATION
 - - - 1 Picofarad - - - 10 Picofarad — 100 Picofarad

TYPICAL ESR vs. FREQUENCY
 AQ11/12
 MIL-PRF-55681E - BG
 STANDARD - M

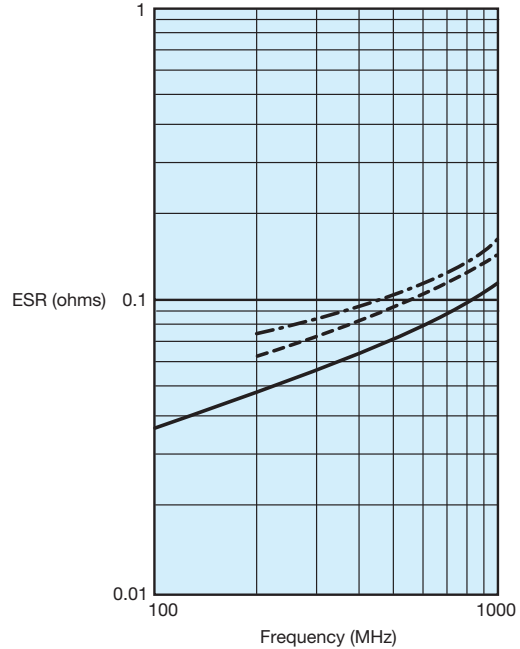

AVX CORPORATION
 - - - 3.3 Picofarad - - - 10 Picofarad — 100 Picofarad

TYPICAL Q vs. CAPACITANCE
 AQ11/12
 MIL-PRF-55681E - BG
 STANDARD - M

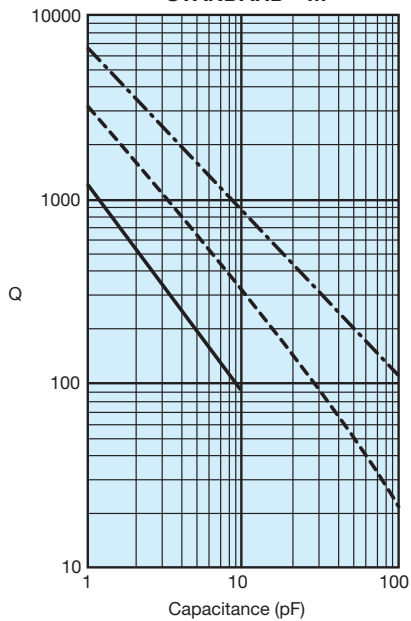

AVX CORPORATION
 - - - 250 MHz - - - 500 MHz — 1000 MHz

TYPICAL ESR vs. CAPACITANCE
 AQ11/12
 MIL-PRF-55681E - BG
 STANDARD - M

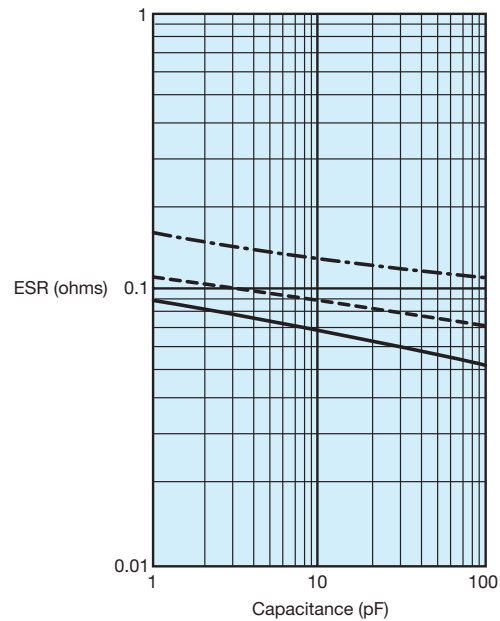

AVX CORPORATION
 — 250 MHz - - - 500 MHz - - - 1000 MHz

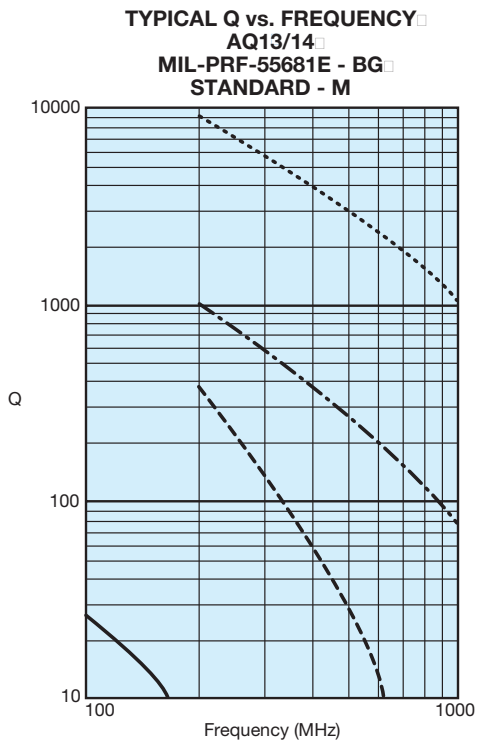

AVX CORPORATION
 1 Picofarad -.-.- 10 Picofarad - - - 47 Picofarad — 330 Picofarad

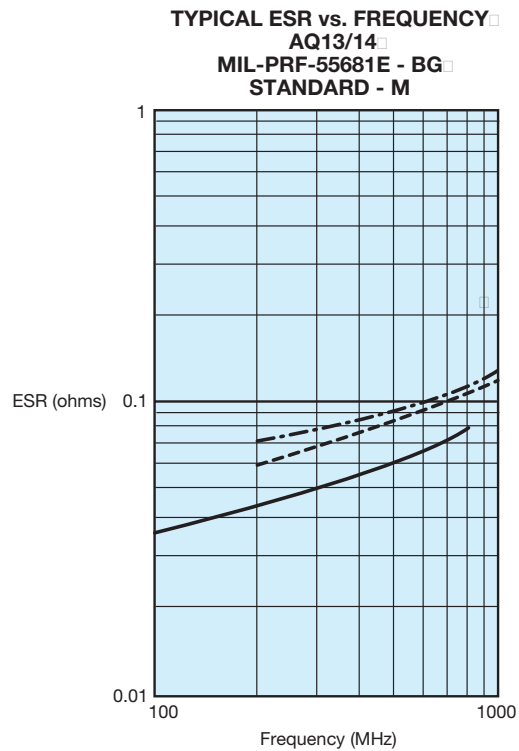

AVX CORPORATION
 1 Picofarad - - - 15 Picofarad — 100 Picofarad

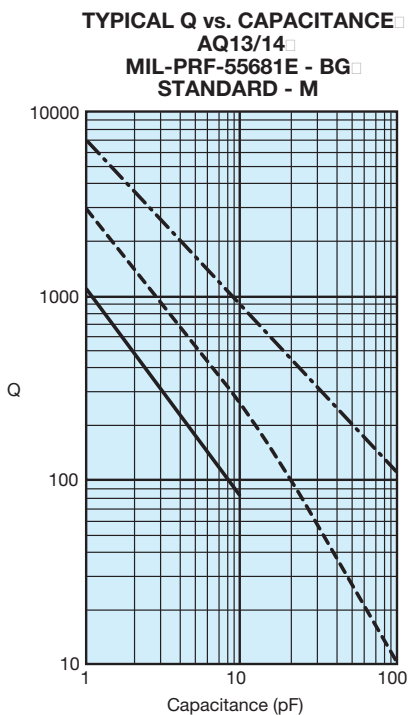

AVX CORPORATION
 250 MHz - - - 500 MHz — 1000 MHz

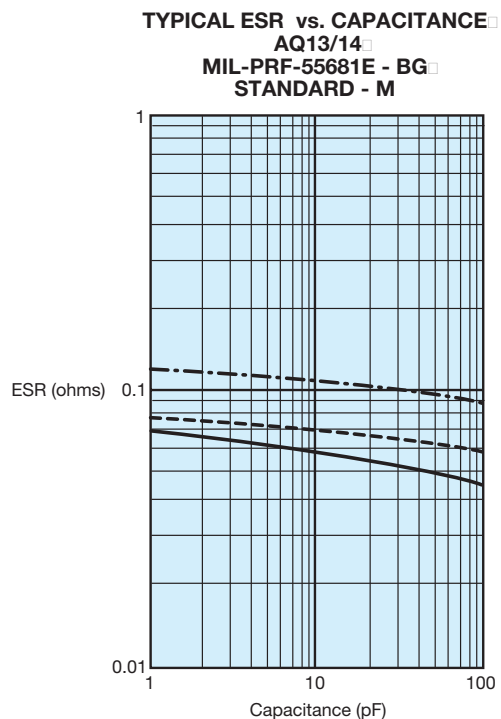

AVX CORPORATION
 250 MHz - - - 500 MHz — 1000 MHz

TYPICAL Q vs. FREQUENCY
 AQ11/12
 MIL-PRF-55681E - BP
 STANDARD - A

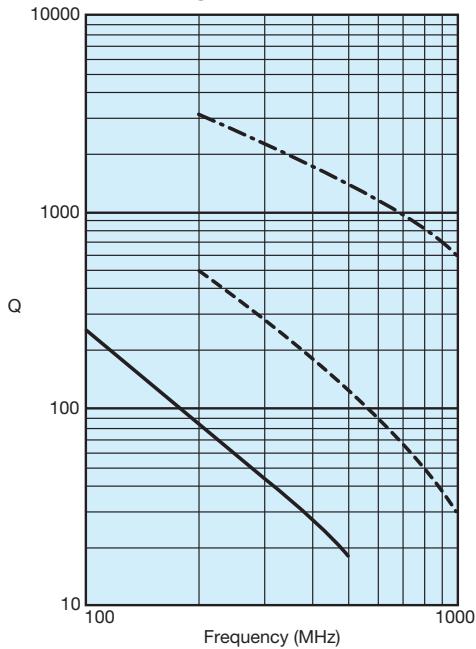

TYPICAL ESR vs. FREQUENCY
 AQ11/12
 MIL-PRF-55681E - BP
 STANDARD - A

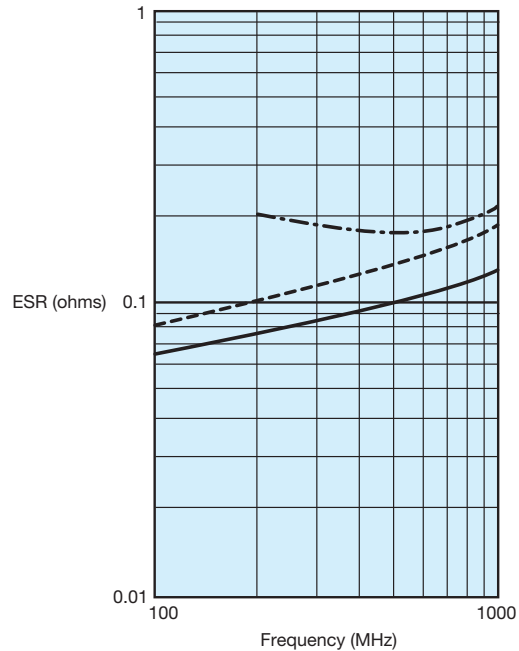

TYPICAL Q vs. CAPACITANCE
 AQ11/12
 MIL-PRF-55681E - BP
 STANDARD - A

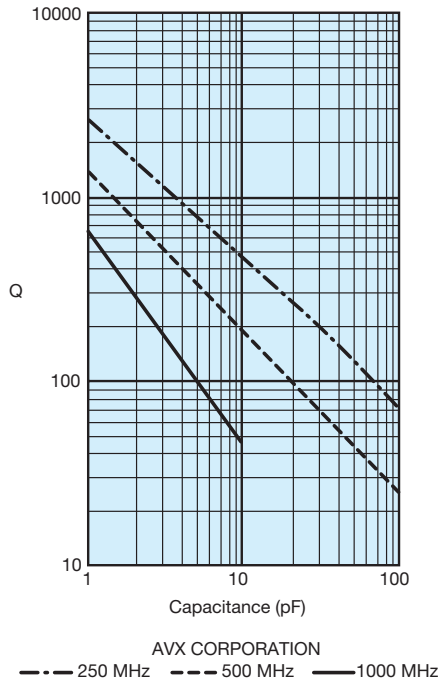

TYPICAL ESR vs. CAPACITANCE
 AQ11/12
 MIL-PRF-55681E - BP
 STANDARD - A

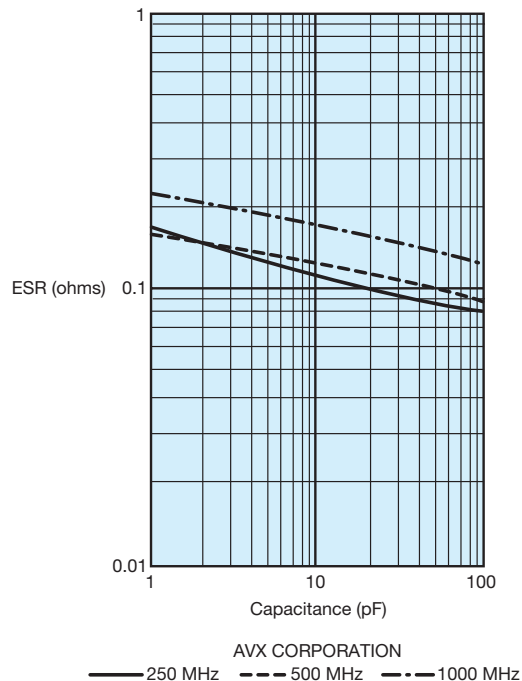

TYPICAL Q vs. FREQUENCY
AQ13/14
MIL-PRF-55681E - BP
STANDARD - A

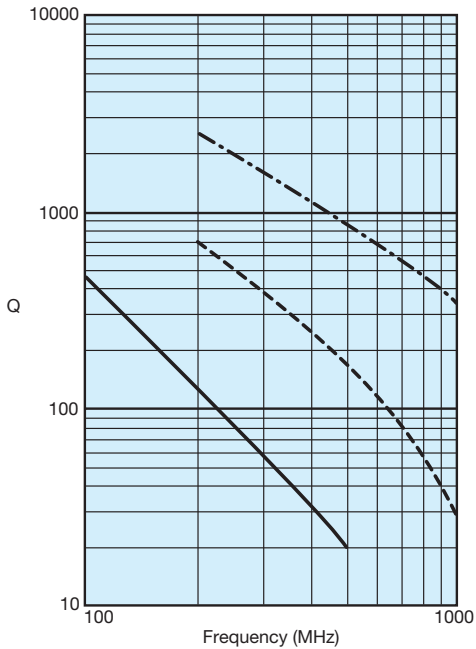

AVX CORPORATION
 --- 2 Picofarad - - - 15 Picofarad — 100 Picofarad

TYPICAL ESR vs. FREQUENCY
AQ13/14
MIL-PRF-55681E - BP
STANDARD - A

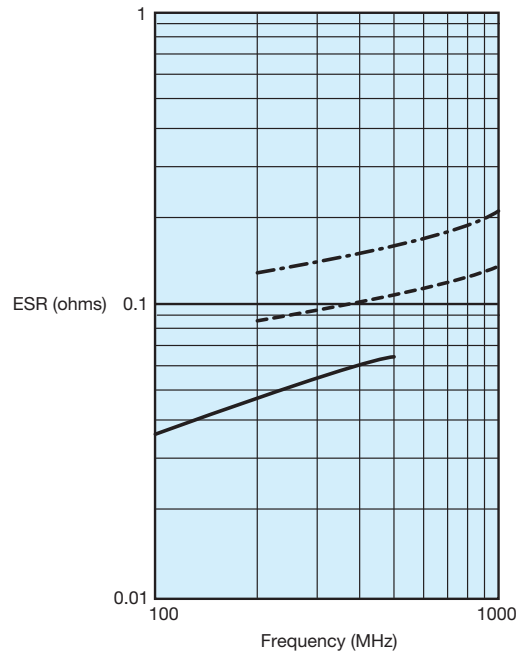

AVX CORPORATION
 - - - 15 Picofarad - - - 47 Picofarad — 100 Picofarad

TYPICAL Q vs. CAPACITANCE
AQ13/14
MIL-PRF-55681E - BP
STANDARD - A

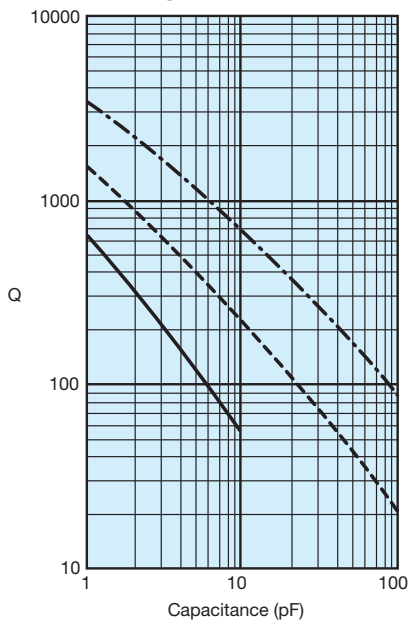

AVX CORPORATION
 - - - 250 MHz - - - 500 MHz — 1000 MHz

TYPICAL ESR vs. CAPACITANCE
AQ13/14
MIL-PRF-55681E - BP
STANDARD - A

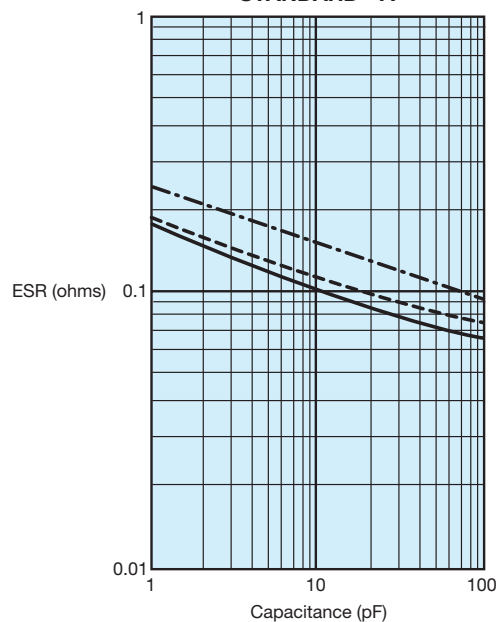

AVX CORPORATION
 — 250 MHz - - - 500 MHz - - - 1000 MHz

TYPICAL RESONANT FREQUENCY vs. CAPACITANCE
AVX AQ11-14 (CDR11-14)

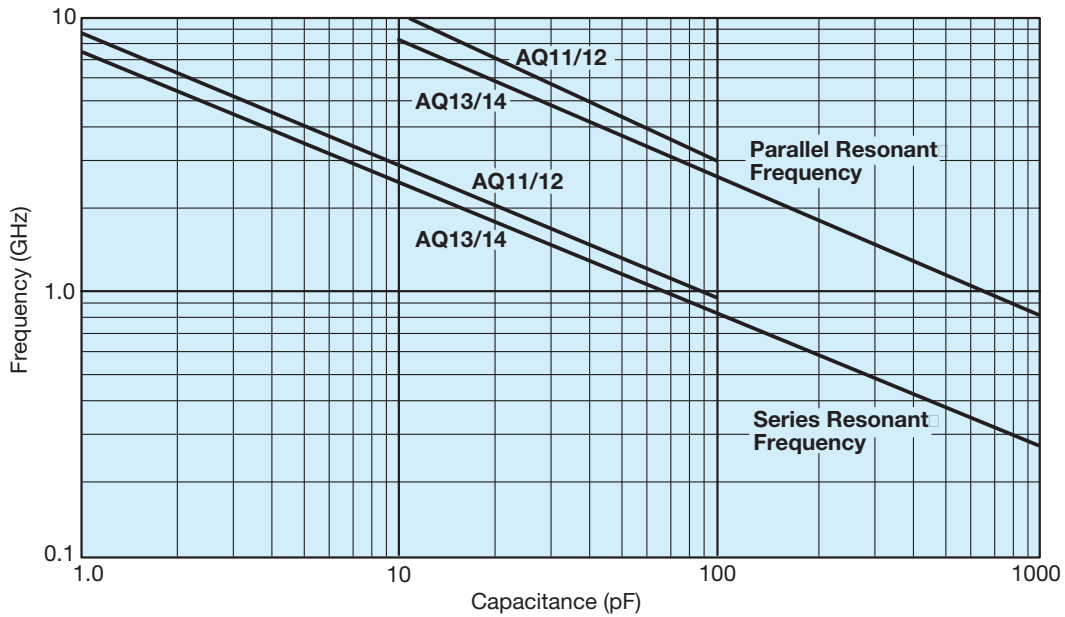

TYPICAL RESONANT FREQUENCY vs. CAPACITANCE
AVX 0603

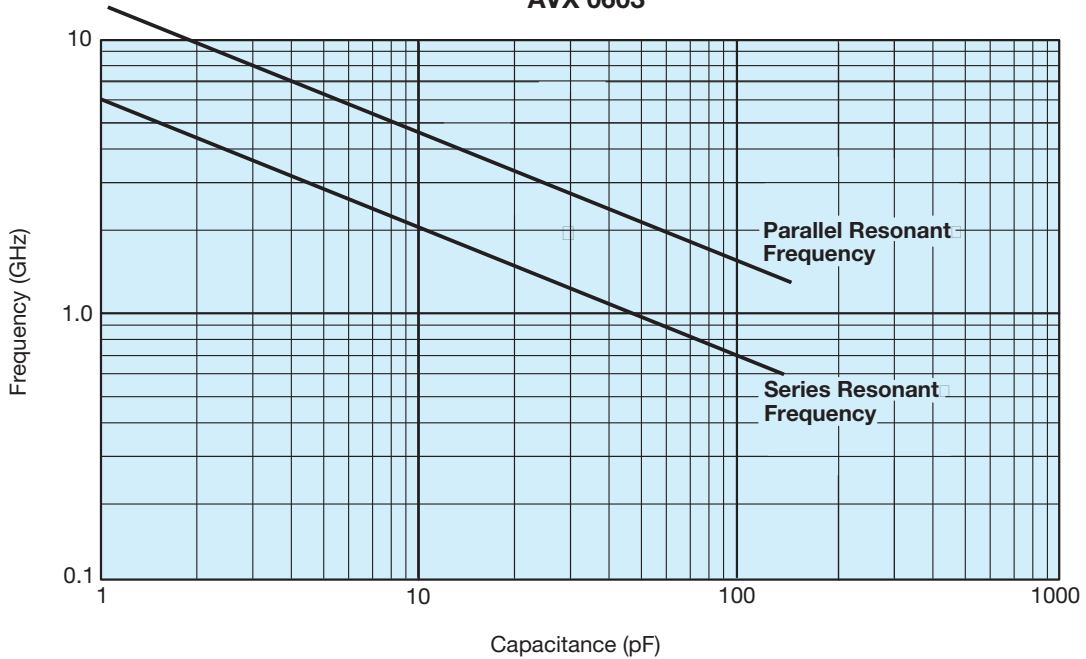

Microwave MLC's

Automatic Insertion Packaging



TAPE & REEL: All tape and reel specifications are in compliance with EIA RS481 (equivalent to IEC 286 part 3).

Sizes SQCA through SQCB, CDR11/12 through 13/14.

- 8mm carrier
- 7" reel: ≤ 0.040 " thickness = 2000 pcs
 ≤ 0.075 " thickness = 2000 pcs
- 13" reel: ≤ 0.075 " thickness = 10,000 pcs

"U" Series - 402/0603/0805/1210 Size Chips

- 8mm carrier
- 7" reel: 0402 = 10,000 pcs
 0603 & 0805 ≤ 0.40 " thickness = 4000 pcs
 0805 . 0.040" thickness & 1210 = 2000 pcs
- 13" reel: ≤ 0.075 " thickness = 10,000 pcs

REEL DIMENSIONS: millimeters (inches)

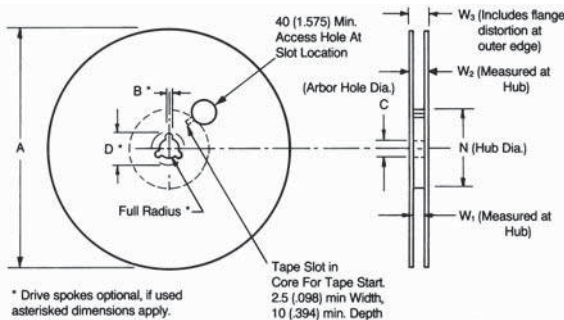

Tape Size ⁽¹⁾	A Max.	B* Min.	C	D* Min.	N Min.	W ₁	W ₂ Max.	W ₃
8mm	330 (12.992)	1.5 (.059)	13.0±0.20 (.512±.008)	20.2 (.795)	50 (1.969)	8.4 ^{+1.0} _{-0.0} (.331 ^{+0.03} _{-0.0})	14.4 (.567)	7.9 Min. (.311) 10.9 Max. (.429)
12mm						12.4 ^{+2.0} _{-0.0} (.488 ^{+0.07} _{-0.0})	18.4 (.724)	11.9 Min. (.469) 15.4 Max. (.607)

Metric dimensions will govern.
 English measurements rounded and for reference only.
 (1) For tape sizes 16mm and 24mm (used with chip size 3640) consult EIA RS-481 latest revision.

EMBOSSED CARRIER CONFIGURATION

8 & 12 MM TAPE ONLY

CONSTANT DIMENSIONS

Tape Size	D ₀	E	P ₀	P ₂	T Max.	T ₁	G ₁	G ₂
8mm and 12mm	8.4 ^{+0.10} _{-0.0} (.059 ^{+0.004} _{-0.0})	1.75 ± 0.10 (.069 ± .004)	4.0 ± 0.10 (.157 ± .004)	2.0 ± 0.05 (.079 ± .002)	0.600 (.024)	0.10 Max. (.004)	0.75 Min. (.030)	0.75 Min. (.030)

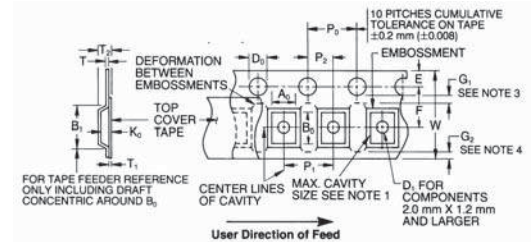

VARIABLE DIMENSIONS

Tape Size	B ₁ Max. See Note 6	D ₁ Min. See Note 5	F	P ₁	R Min. See Note 2	T ₂	W	A ₀ B ₀ K ₀
8mm	4.55 (.179)	1.0 (.039)	3.5 ± 0.05 (.138 ± .002)	4.0 ± 0.10 (.157 ± .004)	25 (.984)	2.5 Max (.098)	8.0 ^{+0.3} _{-0.1} (.315 ^{+0.012} _{-.004})	See Note 1
12mm	8.2 (.323)	1.5 (.059)	5.5 ± 0.05 (.217 ± .002)	4.0 ± 0.10 (.157 ± .004)	30 (1.181)	6.5 Max (.256)	12.0 ± .30 (.472 ± .012)	See Note 1

NOTES:

- A₀, B₀, and K₀ are determined by the max. dimensions to the ends of the terminals extending from the component body and/or the body dimensions of the component. The clearance between the end of the terminals or body of the component to the sides and depth of the cavity (A₀, B₀, and K₀) must be within 0.05 mm (.002) min. and 0.50 mm (.020) max. The clearance allowed must also prevent rotation of the component within the cavity of not more than 20 degrees (see sketches C & D).
- Tape with components shall pass around radius "R" without damage. The minimum trailer length (Note 2 Fig. 3) may require additional length to provide R min. for 12mm embossed tape for reels with hub diameters approaching N min. (Table 4).
- G₁ dimension is the flat area from the edge of the sprocket hole to either the outward deformation of the carrier tape between the embossed cavities or to the edge of the cavity whichever is less.
- G₂ dimension is the flat area from the edge of the carrier tape opposite the sprocket holes to either the outward deformation of the carrier tape between the embossed cavity or to the edge of the cavity whichever is less.
- The embossment hole location shall be measured from the sprocket hole controlling the location of the embossment. Dimensions of embossment location and hole location shall be applied independent of each other.
- B₁ dimension is a reference dimension for tape feeder clearance only.

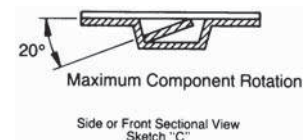
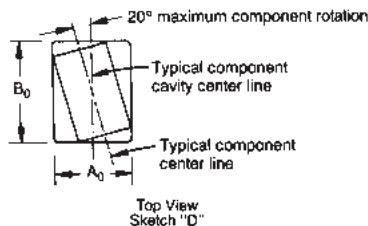

HQ[®] Series High RF Power Capacitors For 600V to 7200V Application



PRODUCT OFFERING

Hi-Q[®], high RF power, surface mount and leaded MLC capacitors from AVX Corporation are characterized with ultra-low ESR and dissipation factor at high frequencies. They are designed to handle high power and high voltage levels for applications in RF power amplifiers, inductive heating, high magnetic field environments (MRI coils), medical and industrial electronics.

HOW TO ORDER

HQCC	A	A	271	J	A	T	1	A
AVX Style	Voltage	Temperature Coefficient	Capacitance Code (2 significant digits + no. of zeros) Examples: 4.7 pF = 4R7 10 pF = 100 100 pF = 101 1,000 pF = 102	Capacitance Tolerance	Test Level	Termination	Packaging	Special Code
HQCC	600V = C 1000V = A 1500V = S 2000V = G 2500V = W 3000V = H 4000V = J 5000V = K 7200V = M	COG = A		C = ±0.25pF (<13pF) D = ±0.50pF (<25pF) F = ±1% (≥25pF) G = ±2% (≥13pF) J = ±5% K = ±10% M = ±20%	A = Standard	1 = Pd/Ag (non-mag) T = Plated Ni and Sn (RoHS Compliant) J = 5% Min Pb M = Microstrip (non-mag) A = Axial (non-mag)	1 = 7" Reel 3 = 13" Reel 9 = Bulk	A = Standard

DIELECTRIC PERFORMANCE CHARACTERISTICS

Capacitance Range	3.3pF to 6,800pF (25°C, 1.0 ±0.2 Vrms at 1kHz, for ≤ 1000 pF use 1MHz)
Capacitance Tolerances	±0.25pF, ±0.50pF, ±1%, ±2%, ±5%, ±10%, ±20%
Dissipation Factor 25°C	0.1% Max (+25°C, 1.0 ±0.2 Vrms at 1kHz, for ≤ 1000 pF use 1MHz)
Operating Temperature Range	-55°C to +125°C
Temperature Characteristic	COG: 0 ± 30 ppm/°C (-55°C to +125°C)
Voltage Ratings	600, 1000, 1500, 2000, 2500, 3000, 4000, 5000, 7200VDC
Insulation Resistance	100K MΩ min. @ +25°C and 500VDC 10K MΩ min. @ +125°C and 500VDC
Dielectric Strength	120% of rated WVDC

HIGH VOLTAGE CAPACITANCE VALUES (pF)

Style	600 WDC min./max.	1000 WVDC min./max.	1500 WVDC min./max.	2000 WVDC min./max.	2500 WVDC min./max.	3000 WVDC min./max.	4000 WVDC min./max.	5000 WVDC min./max.	7200 WVDC min./max.
HQCC	2,200 - 2,700	1,500 - 1,800	820 - 1,200	470 - 680	330 - 390	4.7 - 270			
HQCE	5,600 - 6,800	3,300 - 4,700	2,200 - 2,700	1,200 - 1,800	820 - 1,000	470-680	220-390	120 - 180	3.3 - 100



HQ[®] Series High RF Power Capacitors



Surface Mount

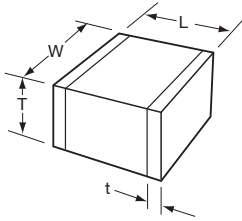

DIMENSIONS millimeters (inches)				
Style	(L) Length	(W) Width	(T) Thickness Max.	(t) terminal
HQCC	5.84 ± 0.51 (0.230 ± 0.020)	6.35 ± 0.51 (0.250 ± 0.020)	3.3 max. (0.130 max.)	0.64 ± 0.38 (0.025 ± 0.015)
HQCE	9.4 ± 0.51 (0.370 ± 0.020)	9.9 ± 0.51 (0.390 ± 0.020)	3.3 max. (0.130 max.)	0.64 ± 0.38 (0.025 ± 0.015)

Microstrip Leads (Lead Style "M")

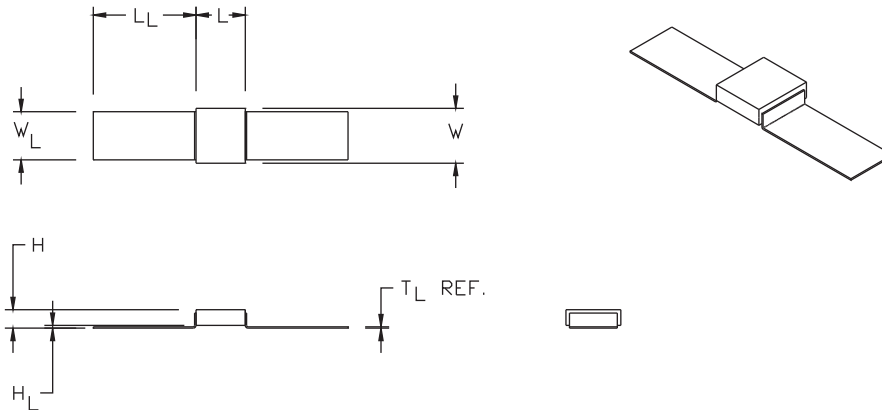

DIMENSIONS millimeters (inches)							
Unit Size	L ±0.51 (0.020)	L _L Min.	W ±0.64 (0.025)	W _L ±0.38 (0.015)	H ±0.64 (0.025)	H _L ±0.38 (0.015)	T _L Ref.
HQLC	5.72 (0.225)	12.7 (0.500)	6.35 (0.250)	6.10 (0.240)	3.68 (0.145)	0.64 (0.025)	0.10 (0.004)
HQLE	9.40 (0.370)	19.1 (0.750)	10.2 (0.400)	8.89 (0.350)	3.68 (0.145)	0.64 (0.025)	0.25 (0.010)

Note: Side to side lead alignment shall be within ±0.25 (0.010)

Axial Ribbon Leads (Lead Style "A")

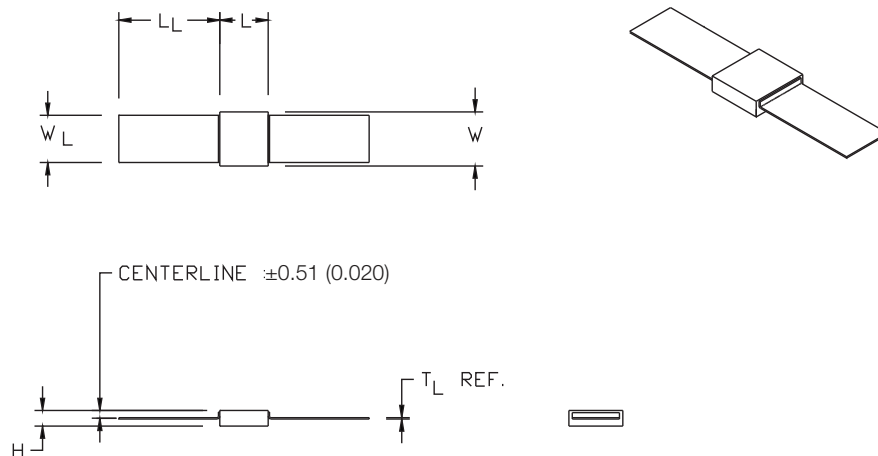

DIMENSIONS millimeters (inches)						
Unit Size	L ±0.51 (0.020)	L _L Min.	W ±0.64 (0.025)	W _L ±0.38 (0.015)	H ±0.64 (0.025)	T _L Ref.
HQLC	5.72 (0.225)	12.7 (0.500)	6.35 (0.250)	6.10 (0.240)	3.18 (0.125)	0.10 (0.004)
HQLE	9.40 (0.370)	19.1 (0.750)	10.2 (0.400)	8.89 (0.350)	3.18 (0.125)	0.25 (0.010)

Note: Side to side lead alignment shall be within ±0.25 (0.010)

PERFORMANCE CHARACTERISTICS

Typical Series Resonant Frequency vs. Capacitance
HQ C Case

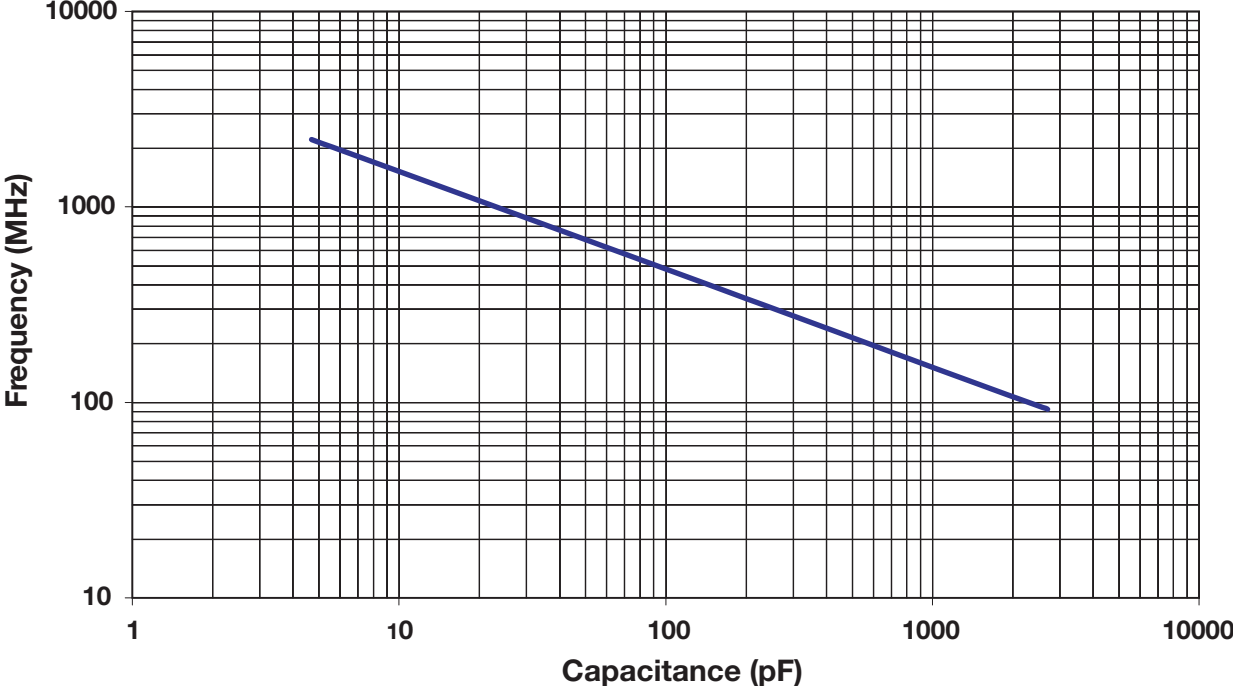

Typical ESR vs. Capacitance
HQ C Case

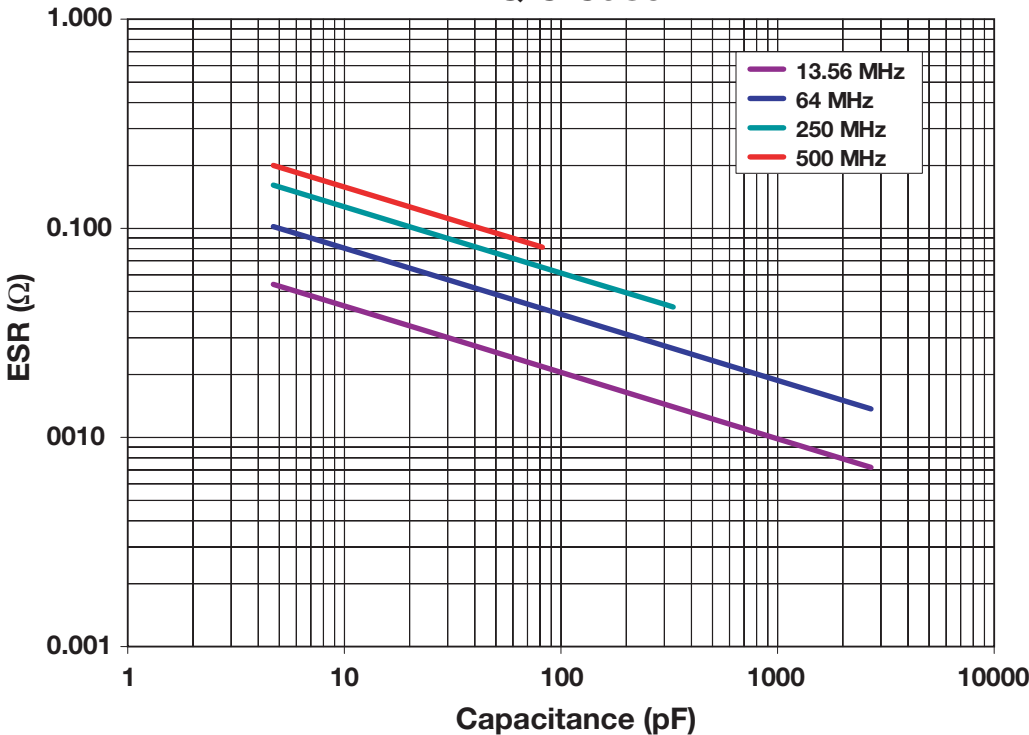

Typical Quality Factor vs. Capacitance
HQ C Case

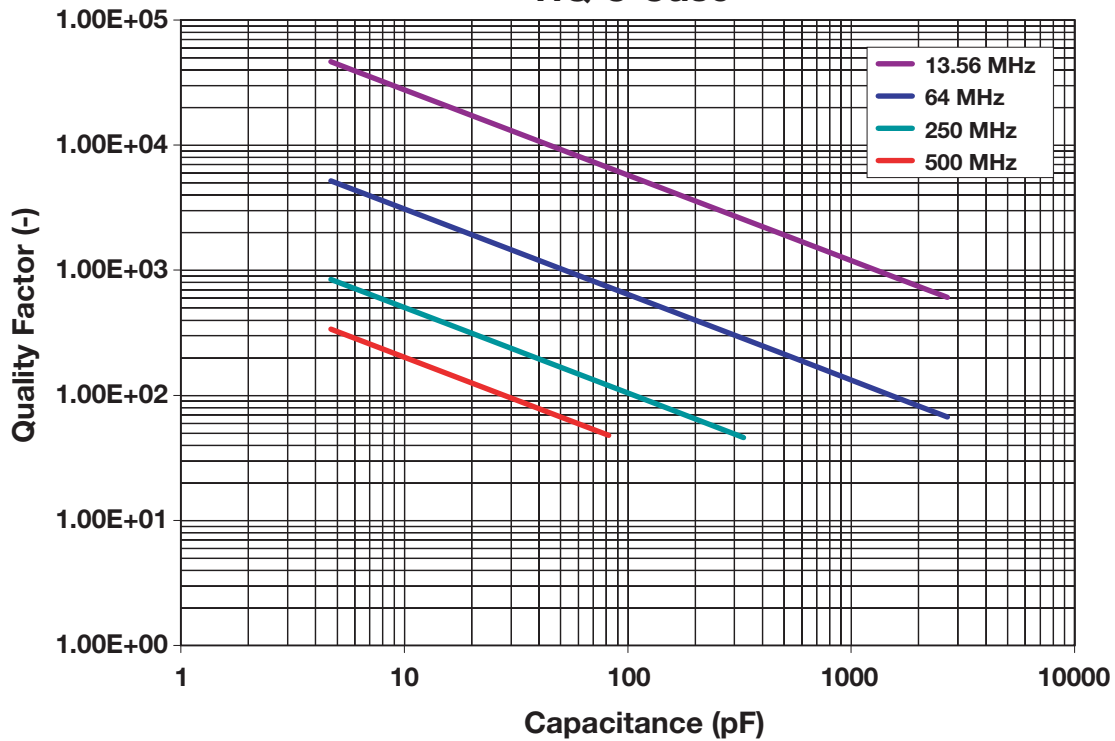

Maximum RMS Current vs. Capacitance
HQ C Case

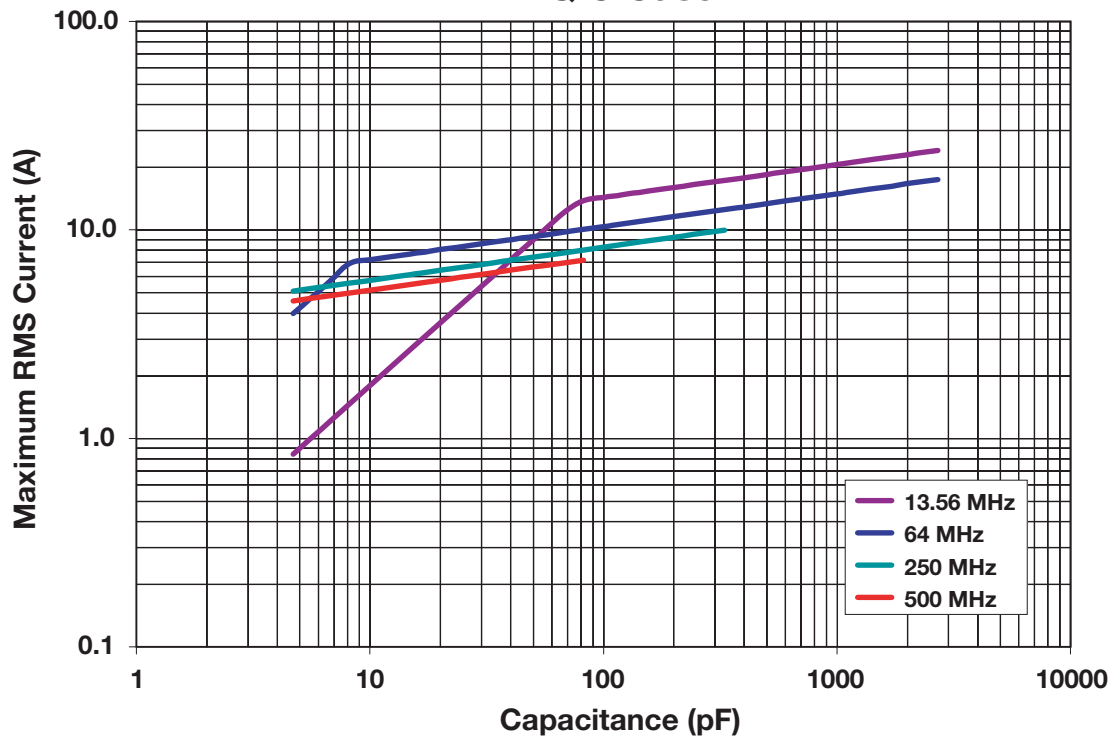

6

Typical Series Resonant Frequency vs. Capacitance HQ E Case

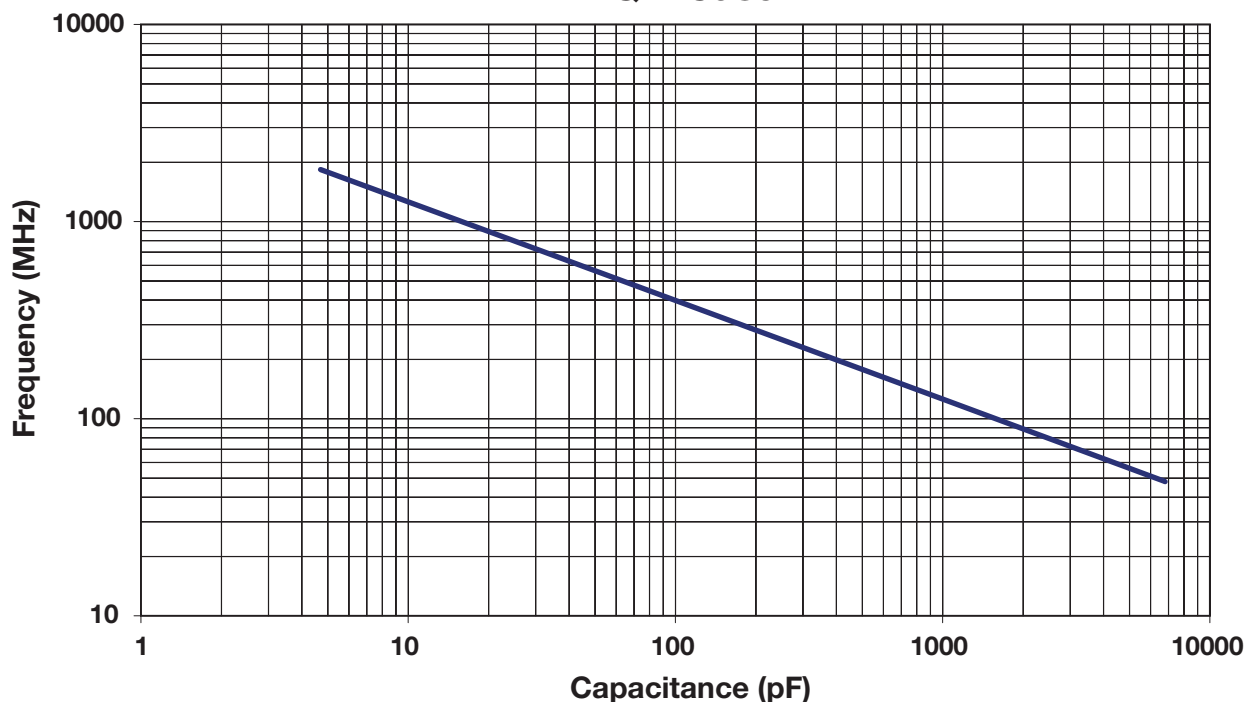

Typical ESR vs. Capacitance HQ E Case

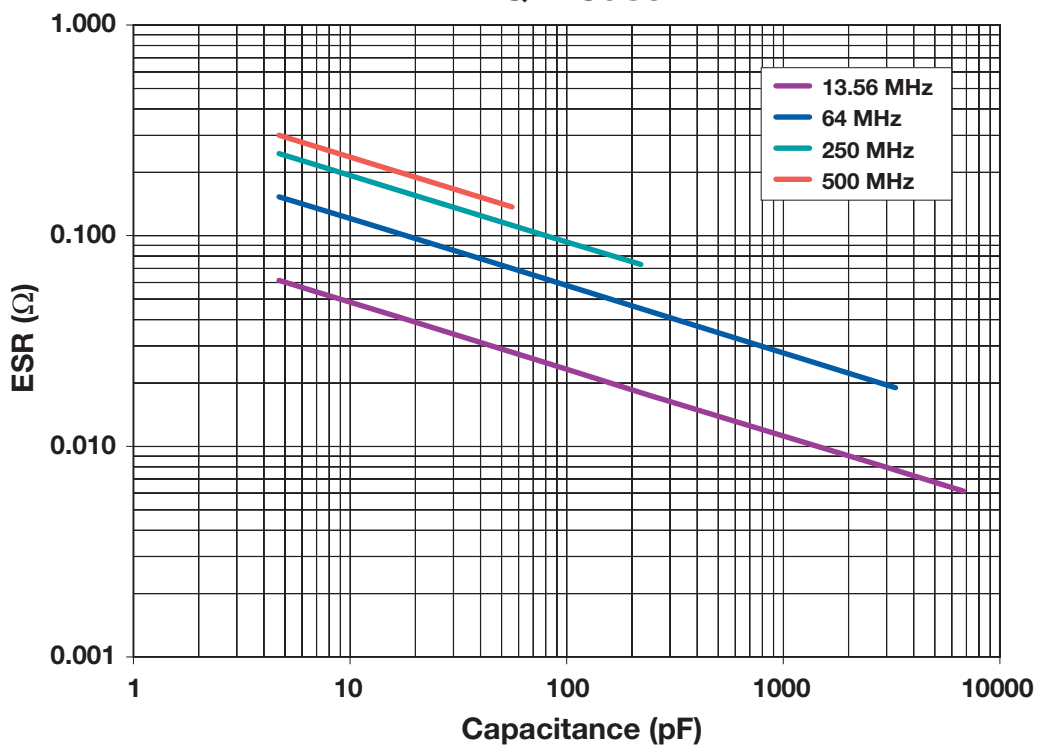

Typical Quality Factor vs. Capacitance
HQ E Case

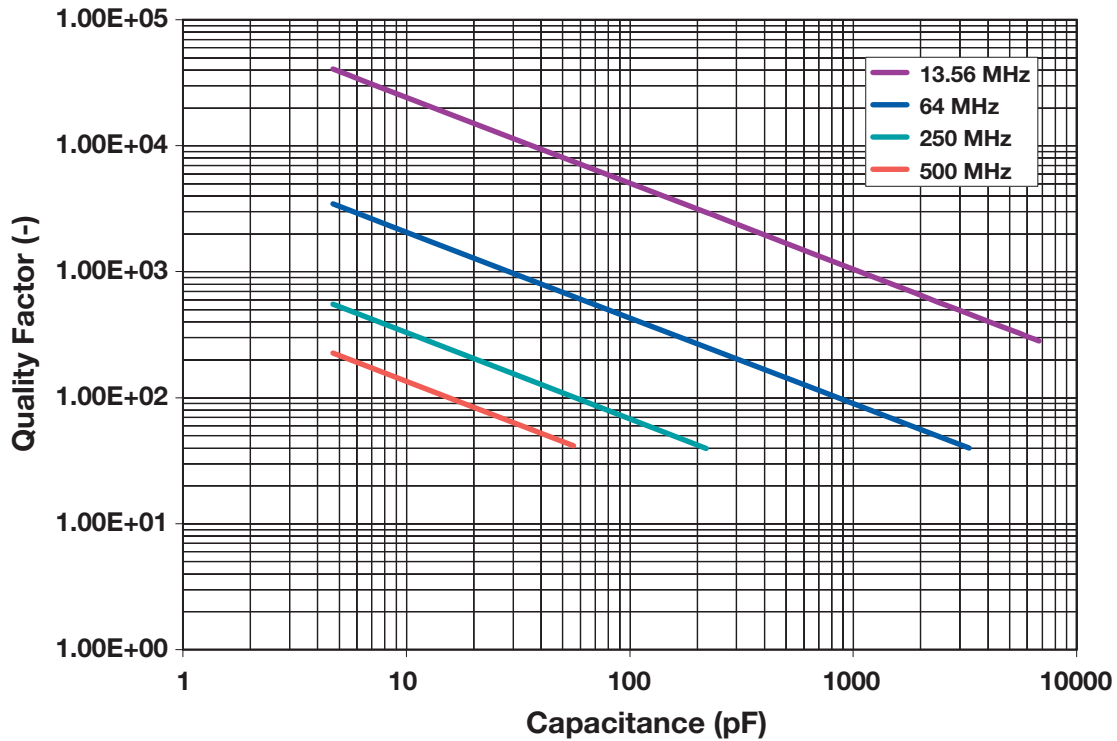

Maximum RMS Current vs. Capacitance
HQ E Case

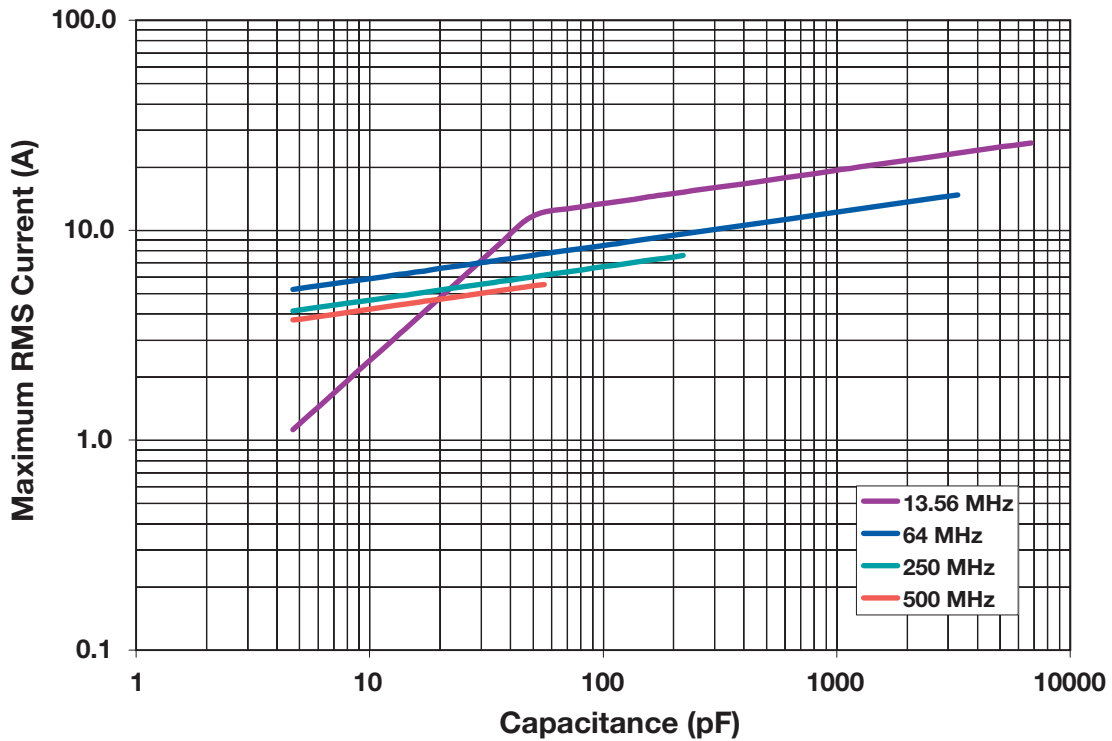

6

AVX RF

**RF/Microwave
NPO Capacitors**

“U” Series
Ceramic C0G (NPO) Microwave
Multilayer Capacitors

RF/Microwave COG (NP0) Capacitors (RoHS)



Ultra Low ESR, "U" Series, COG (NP0) Chip Capacitors

GENERAL INFORMATION

"U" Series capacitors are COG (NP0) chip capacitors specially designed for "Ultra" low ESR for applications in the communications market. Max ESR and effective capacitance

are met on each value producing lot to lot uniformity. Sizes available are EIA chip sizes 0603, 0805, and 1210.

DIMENSIONS: inches (millimeters)

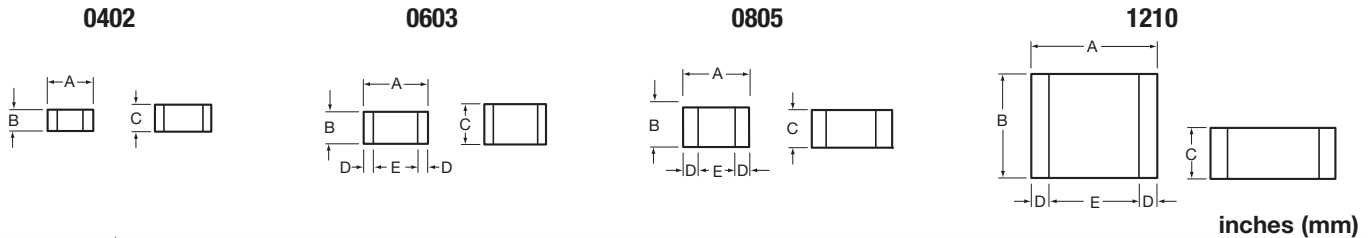

Size	A	B	C	D	E
0402	0.039±0.004 (1.00±0.1)	0.020±0.004 (0.50±0.1)	0.024 (0.6) max	N/A	N/A
0603	0.060±0.010 (1.52±0.25)	0.030±0.010 (0.76±0.25)	0.036 (0.91) max	0.010±0.005 (0.25±0.13)	0.030 (0.76) min
0805	0.079±0.008 (2.01±0.2)	0.049±0.008 (1.25±0.2)	0.040±0.005 (1.02±0.127)	0.020±0.010 (0.51±0.254)	0.020 (0.51) min
1210	0.126±0.008 (3.2±0.2)	0.098±0.008 (2.49±0.2)	0.050±0.005 (1.27±0.127)	0.025±0.015 (0.635±0.381)	0.040 (1.02) min

HOW TO ORDER

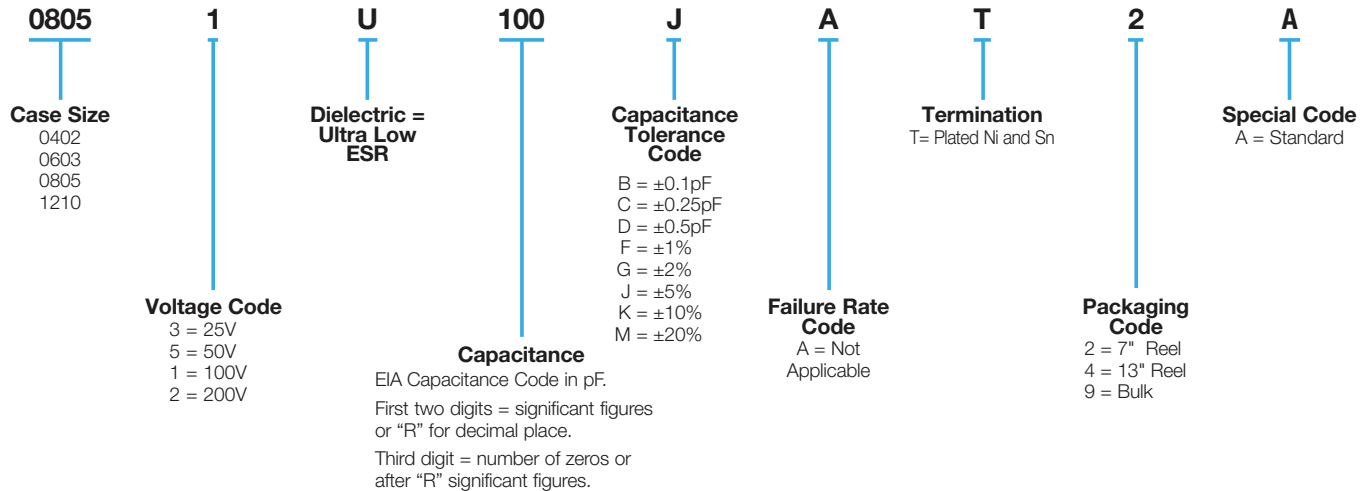

7 ELECTRICAL CHARACTERISTICS

Capacitance Values and Tolerances:

- Size 0402 - 0.2 pF to 22 pF @ 1 MHz
- Size 0603 - 1.0 pF to 100 pF @ 1 MHz
- Size 0805 - 1.6 pF to 160 pF @ 1 MHz
- Size 1210 - 2.4 pF to 1000 pF @ 1 MHz

Temperature Coefficient of Capacitance (TC):

0±30 ppm/°C (-55° to +125°C)

Insulation Resistance (IR):

- 10¹² Ω min. @ 25°C and rated WVDC
- 10¹¹ Ω min. @ 125°C and rated WVDC

Working Voltage (WVDC):

- | | |
|------|---------------------|
| Size | Working Voltage |
| 0402 | - 50, 25 WVDC |
| 0603 | - 200, 100, 50 WVDC |
| 0805 | - 200, 100 WVDC |
| 1210 | - 200, 100 WVDC |

Dielectric Working Voltage (DWV):

250% of rated WVDC

Equivalent Series Resistance Typical (ESR):

- 0402 - See Performance Curve, page 137
- 0603 - See Performance Curve, page 137
- 0805 - See Performance Curve, page 137
- 1210 - See Performance Curve, page 137

Marking: Laser marking EIA J marking standard (except 0603) (capacitance code and tolerance upon request).

MILITARY SPECIFICATIONS

Meets or exceeds the requirements of MIL-C-55681



RF/Microwave C0G (NP0) Capacitors (RoHS)



Ultra Low ESR, "U" Series, C0G (NP0) Chip Capacitors

CAPACITANCE RANGE

Cap (pF)	Available Tolerance	Size				Cap (pF)	Available Tolerance	Size				Cap (pF)	Available Tolerance	Size				Cap (pF)	Available Tolerance	Size			
		0402	0603	0805	1210			0402	0603	0805	1210			0402	0603	0805	1210			0402	0603	0805	1210
0.2	B,C	50V	N/A	N/A	N/A	1.0	B,C,D	50V	200V	200V	200V	7.5	B,C,J,K,M	50V	200V	200V	200V	100	F,G,J,K,M	N/A	100V	200V	200V
0.3	B,C	↓	↓	↓	↓	1.1	↓	↓	↓	↓	↓	8.2	↓	↓	↓	↓	↓	110	↓	↓	↓	↓	↓
0.4	B,C	↓	↓	↓	↓	1.2	↓	↓	↓	↓	↓	9.1	B,C,J,K,M	↓	↓	↓	↓	120	↓	↓	↓	↓	↓
0.5	B,C	↓	↓	↓	↓	1.3	↓	↓	↓	↓	↓	10	F,G,J,K,M	↓	↓	↓	↓	130	↓	↓	↓	↓	↓
0.6	B,C,D	↓	↓	↓	↓	1.4	↓	↓	↓	↓	↓	11	↓	↓	↓	↓	↓	140	↓	↓	↓	↓	↓
0.7	B,C,D	↓	↓	↓	↓	1.5	↓	↓	↓	↓	↓	12	↓	↓	↓	↓	↓	150	↓	↓	↓	↓	↓
0.8	B,C,D	↓	↓	↓	↓	1.6	↓	↓	↓	↓	↓	13	↓	↓	↓	↓	↓	160	↓	↓	↓	↓	↓
0.9	B,C,D	↓	↓	↓	↓	1.7	↓	↓	↓	↓	↓	15	↓	↓	↓	↓	↓	180	↓	↓	↓	↓	↓
						1.8	↓	↓	↓	↓	↓	18	↓	↓	↓	↓	↓	200	↓	↓	↓	↓	↓
						1.9	↓	↓	↓	↓	↓	20	↓	↓	↓	↓	↓	220	↓	↓	↓	↓	↓
						2.0	↓	↓	↓	↓	↓	22	↓	↓	↓	↓	↓	270	↓	↓	↓	↓	↓
						2.1	↓	↓	↓	↓	↓	24	↓	↓	↓	↓	↓	300	↓	↓	↓	↓	↓
						2.2	↓	↓	↓	↓	↓	27	↓	↓	↓	↓	↓	330	↓	↓	↓	↓	↓
						2.4	↓	↓	↓	↓	↓	30	↓	↓	↓	↓	↓	360	↓	↓	↓	↓	↓
						2.7	↓	↓	↓	↓	↓	33	↓	↓	↓	↓	↓	390	↓	↓	↓	↓	↓
						3.0	↓	↓	↓	↓	↓	36	↓	↓	↓	↓	↓	430	↓	↓	↓	↓	↓
						3.3	↓	↓	↓	↓	↓	39	↓	↓	↓	↓	↓	470	↓	↓	↓	↓	↓
						3.6	↓	↓	↓	↓	↓	43	↓	↓	↓	↓	↓	510	↓	↓	↓	↓	↓
						3.9	↓	↓	↓	↓	↓	47	↓	↓	↓	↓	↓	560	↓	↓	↓	↓	↓
						4.3	↓	↓	↓	↓	↓	51	↓	↓	↓	↓	↓	620	↓	↓	↓	↓	↓
						4.7	↓	↓	↓	↓	↓	56	↓	↓	↓	↓	↓	680	↓	↓	↓	↓	↓
						5.1	↓	↓	↓	↓	↓	68	↓	↓	↓	↓	↓	750	↓	↓	↓	↓	↓
						5.6	↓	↓	↓	↓	↓	75	↓	↓	↓	↓	↓	820	↓	↓	↓	↓	↓
						6.2	B,C,D	↓	↓	↓	↓	82	↓	↓	↓	↓	↓	910	↓	↓	↓	↓	↓
						6.8	B,C,J,K,M	↓	↓	↓	↓	91	↓	↓	↓	↓	↓	1000	F,G,J,K,M	↓	↓	↓	↓

ULTRA LOW ESR, "U" SERIES

TYPICAL ESR vs. FREQUENCY
0402 "U" SERIES

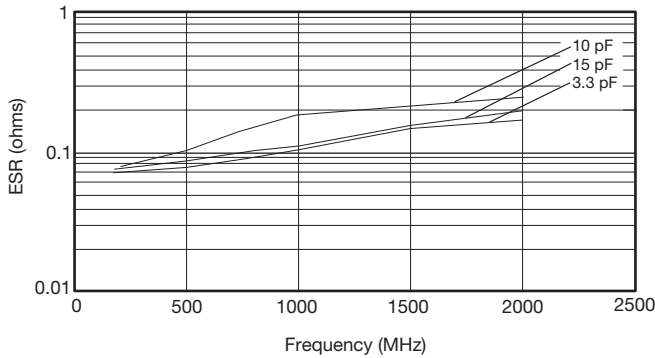

TYPICAL ESR vs. FREQUENCY
0603 "U" SERIES

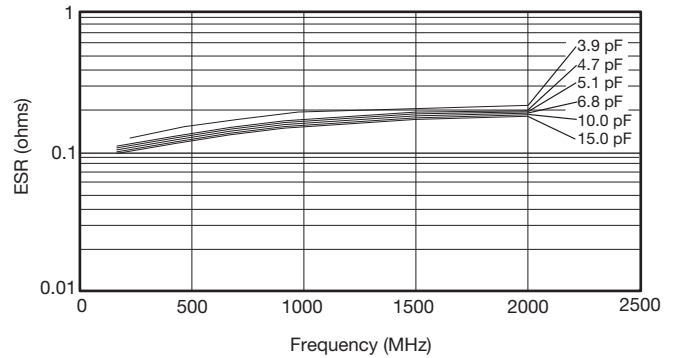

TYPICAL ESR vs. FREQUENCY
0805 "U" SERIES

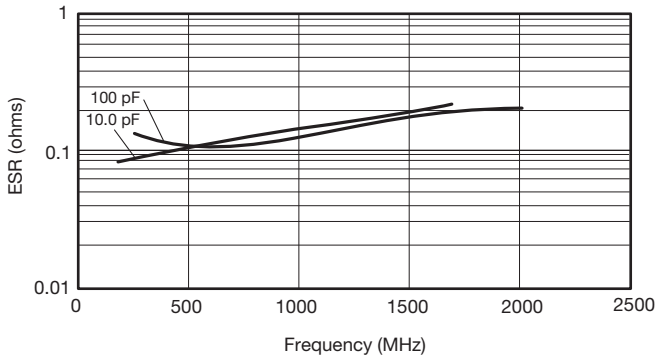

TYPICAL ESR vs. FREQUENCY
1210 "U" SERIES

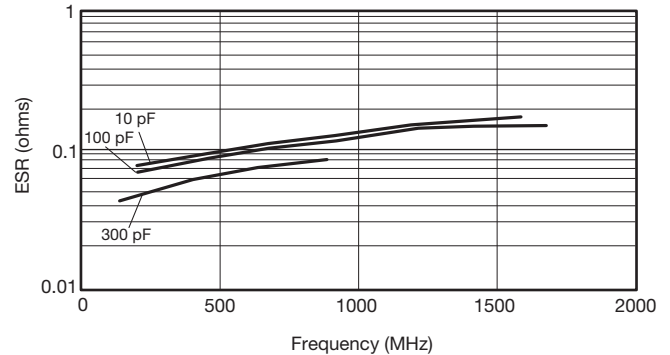

ESR Measured on the Boonton 34A

RF/Microwave C0G (NP0) Capacitors (RoHS)



Ultra Low ESR, "U" Series, C0G (NP0) Chip Capacitors

TYPICAL
SERIES RESONANT FREQUENCY
"U" SERIES CHIP

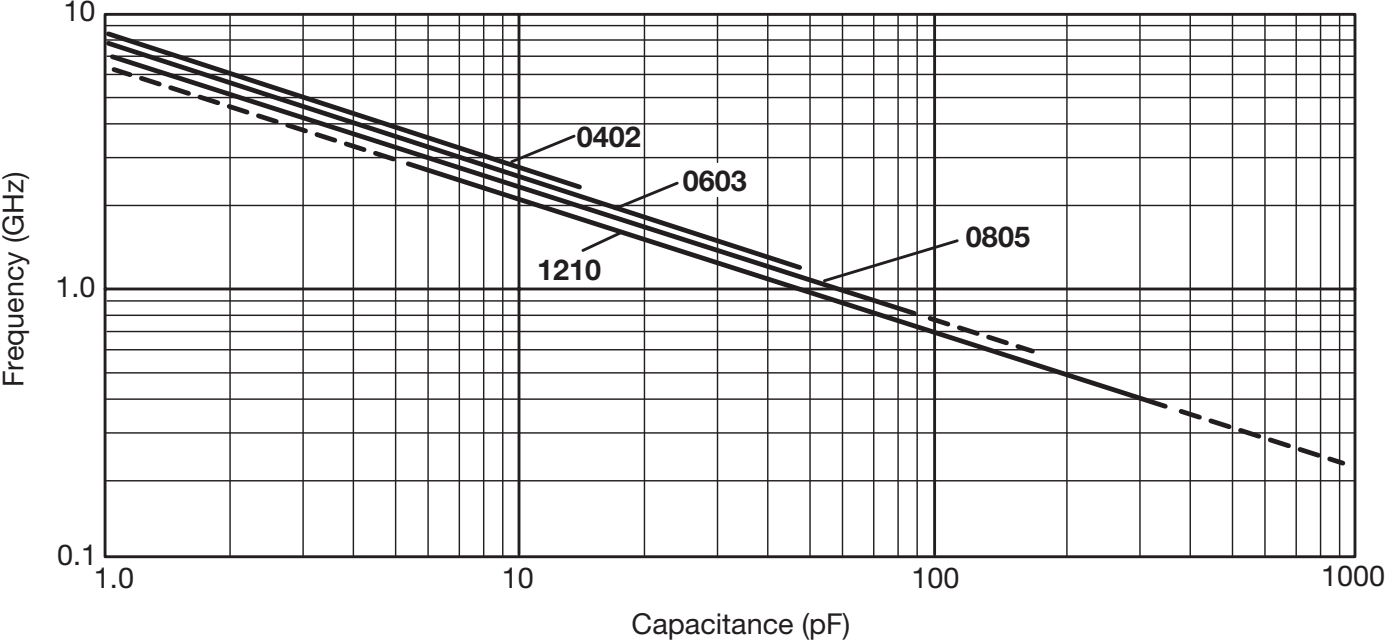

7



RF/Microwave C0G (NP0) Capacitors (Sn/Pb)



Ultra Low ESR, "U" Series, C0G (NP0) Chip Capacitors

GENERAL INFORMATION

"U" Series capacitors are C0G (NP0) chip capacitors specially designed for "Ultra" low ESR for applications in the communications market. Max ESR and effective capacitance

are met on each value producing lot to lot uniformity. Sizes available are EIA chip sizes 0603, 0805, and 1210.

DIMENSIONS: inches (millimeters)

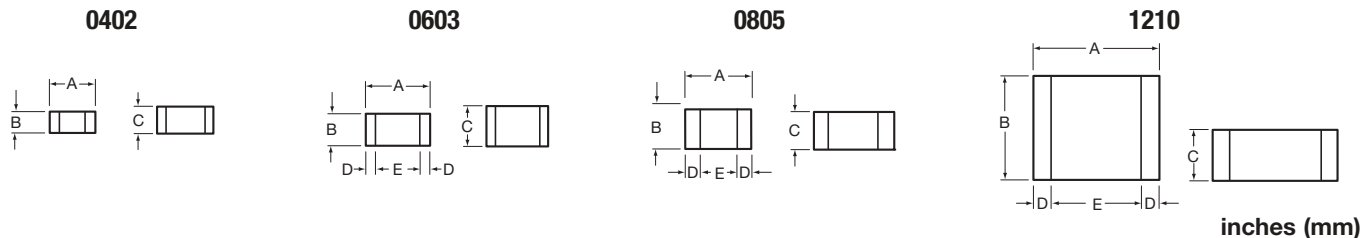

Size	A	B	C	D	E
0402	0.039±0.004 (1.00±0.1)	0.020±0.004 (0.50±0.1)	0.024 (0.6) max	N/A	N/A
0603	0.060±0.010 (1.52±0.25)	0.030±0.010 (0.76±0.25)	0.036 (0.91) max	0.010±0.005 (0.25±0.13)	0.030 (0.76) min
0805	0.079±0.008 (2.01±0.2)	0.049±0.008 (1.25±0.2)	0.040±0.005 (1.02±0.127)	0.020±0.010 (0.51±0.254)	0.020 (0.51) min
1210	0.126±0.008 (3.2±0.2)	0.098±0.008 (2.49±0.2)	0.050±0.005 (1.27±0.127)	0.025±0.015 (0.635±0.381)	0.040 (1.02) min

HOW TO ORDER

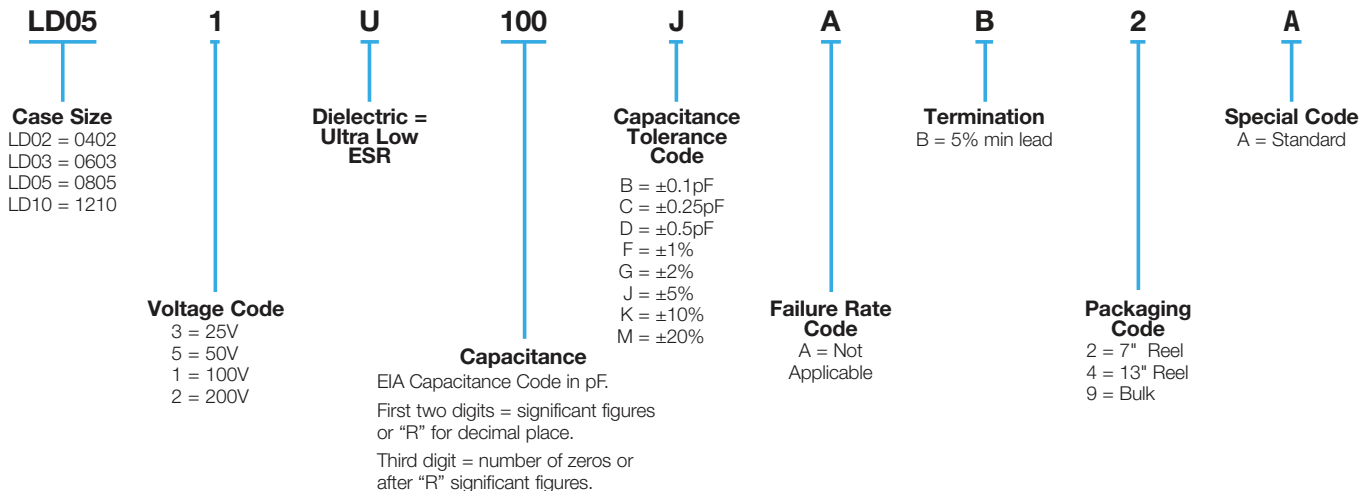

ELECTRICAL CHARACTERISTICS

Capacitance Values and Tolerances:

- Size 0402 - 0.2 pF to 22 pF @ 1 MHz
- Size 0603 - 1.0 pF to 100 pF @ 1 MHz
- Size 0805 - 1.6 pF to 160 pF @ 1 MHz
- Size 1210 - 2.4 pF to 1000 pF @ 1 MHz

Temperature Coefficient of Capacitance (TC):

0±30 ppm/°C (-55° to +125°C)

Insulation Resistance (IR):

- 10¹² Ω min. @ 25°C and rated WVDC
- 10¹¹ Ω min. @ 125°C and rated WVDC

Working Voltage (WVDC):

- Size Working Voltage
- 0402 - 50, 25 WVDC
- 0603 - 200, 100, 50 WVDC
- 0805 - 200, 100 WVDC
- 1210 - 200, 100 WVDC

Dielectric Working Voltage (DWV):

250% of rated WVDC

Equivalent Series Resistance Typical (ESR):

- 0402 - See Performance Curve, page 140
- 0603 - See Performance Curve, page 140
- 0805 - See Performance Curve, page 140
- 1210 - See Performance Curve, page 140

Marking: Laser marking EIA J marking standard (except 0603) (capacitance code and tolerance upon request).

MILITARY SPECIFICATIONS

Meets or exceeds the requirements of MIL-C-55681



RF/Microwave C0G (NP0) Capacitors (Sn/Pb)



Ultra Low ESR, "U" Series, C0G (NP0) Chip Capacitors

CAPACITANCE RANGE

Cap (pF)	Available Tolerance	Size				Cap (pF)	Available Tolerance	Size				Cap (pF)	Available Tolerance	Size			
		LD02	LD03	LD05	LD10			LD02	LD03	LD05	LD10			LD02	LD03	LD05	LD10
0.2	B,C	50V	N/A	N/A	N/A	1.0	B,C,D	50V	200V	200V	200V	100	F,G,J,K,M	N/A	100V	200V	200V
0.3						1.1						110					
0.4						1.2						120					
0.5	B,C					1.3						130					
0.6	B,C,D					1.4						140					
0.7						1.5						150					
0.8						1.6						160					
0.9	B,C,D					1.7						180					
						1.8						200					
						1.9						220					
						2.0						270					
						2.1						300					
						2.2						330					
						2.4						360					
						2.7						390					
						3.0						430					
						3.3						470					
						3.6						510					
						3.9						560					
						4.3						620					
						4.7						680					
						5.1						750					
						5.6						820					
						6.2	B,C,D					910					
						6.8	B,C,J,K,M					1000	F,G,J,K,M				

ULTRA LOW ESR, "U" SERIES

TYPICAL ESR vs. FREQUENCY
0402 "U" SERIES

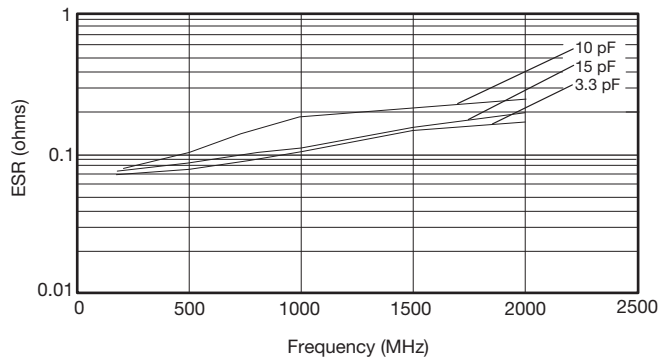

TYPICAL ESR vs. FREQUENCY
0603 "U" SERIES

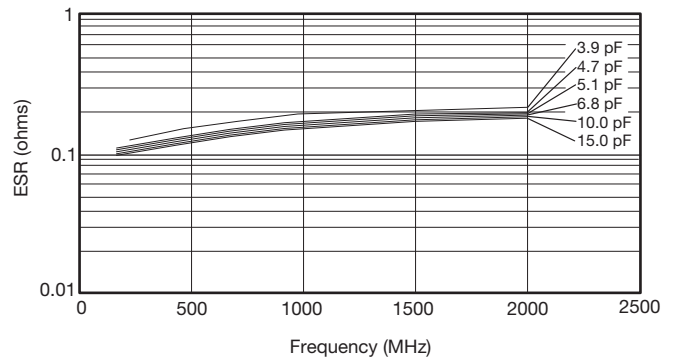

TYPICAL ESR vs. FREQUENCY
0805 "U" SERIES

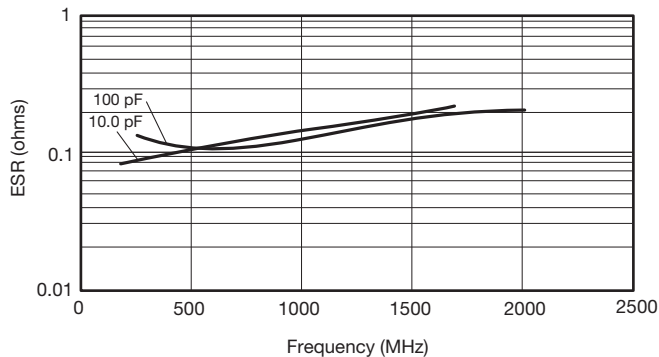

TYPICAL ESR vs. FREQUENCY
1210 "U" SERIES

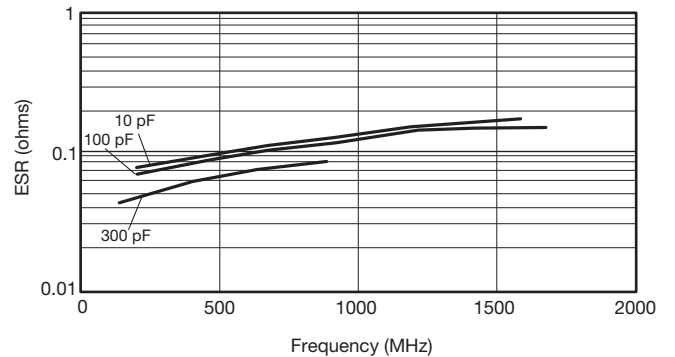

ESR Measured on the Boonton 34A

7

RF/Microwave C0G (NP0) Capacitors (Sn/Pb)



Ultra Low ESR, "U" Series, C0G (NP0) Chip Capacitors

TYPICAL
SERIES RESONANT FREQUENCY
"U" SERIES CHIP

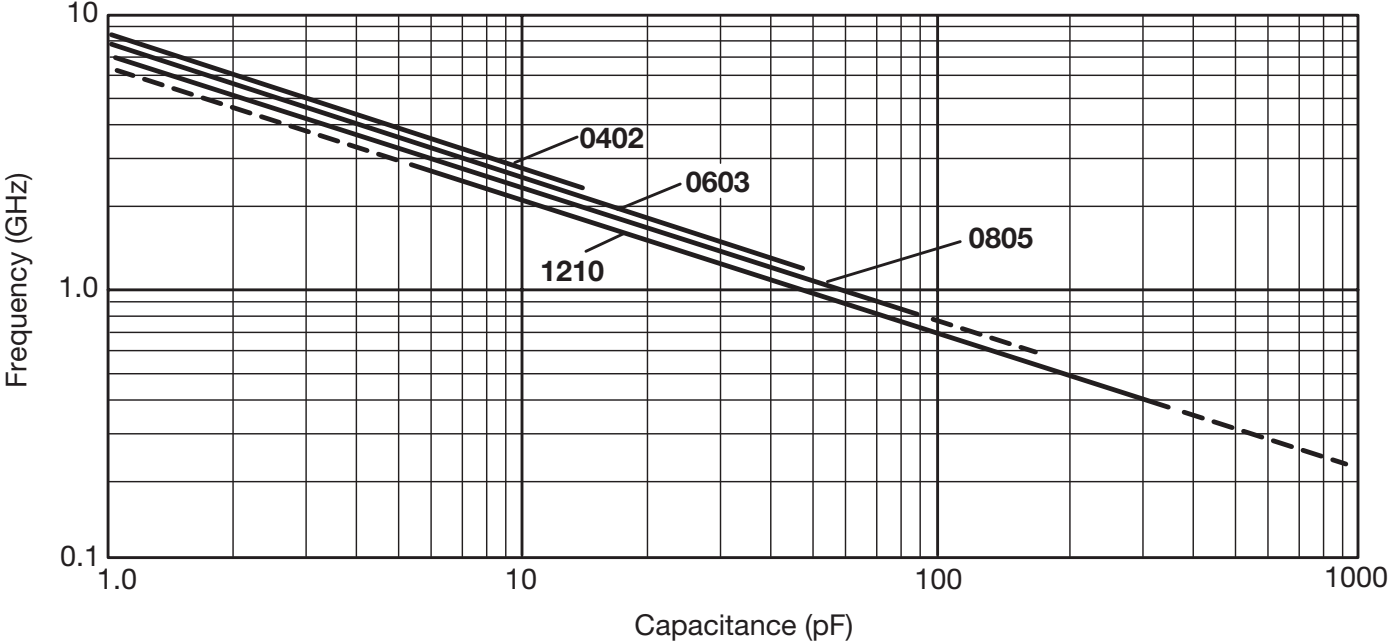

AVX RF

RF/Microwave

“U” Series Designer Kits

“U” Dielectric Kits

0402

Kit 5000 UZ			
Cap. Value pF	Tolerance	Cap. Value pF	Tolerance
0.5	B ($\pm 0.1\text{pF}$)	4.7	B ($\pm 0.1\text{pF}$)
1.0		5.6	
1.5		6.8	
1.8		8.2	
2.2		10.0	
2.4		12.0	
3.0	J ($\pm 5\%$)	15.0	J ($\pm 5\%$)
3.6			

***25 each of 15 values

0603

Kit 4000 UZ			
Cap. Value pF	Tolerance	Cap. Value pF	Tolerance
1.0	B ($\pm 0.1\text{pF}$)	6.8	B ($\pm 0.1\text{pF}$)
1.2		7.5	
1.5		8.2	
1.8		10.0	
2.0		12.0	
2.4		15.0	
2.7		18.0	
3.0		22.0	
3.3		27.0	
3.9		33.0	
4.7		39.0	
5.6		47.0	
	J ($\pm 5\%$)		J ($\pm 5\%$)

***25 each of 24 values

0805

Kit 3000 UZ			
Cap. Value pF	Tolerance	Cap. Value pF	Tolerance
1.0	B ($\pm 0.1\text{pF}$)	15.0	J ($\pm 5\%$)
1.5		18.0	
2.2		22.0	
2.4		24.0	
2.7		27.0	
3.0		33.0	
3.3		36.0	
3.9		39.0	
4.7		47.0	
5.6		56.0	
7.5		68.0	
8.2		82.0	
9.1		100.0	
10.0		J ($\pm 5\%$)	
12.0	160.0		

***25 each of 30 values

1210

Kit 3500 UZ			
Cap. Value pF	Tolerance	Cap. Value pF	Tolerance
2.2	B ($\pm 0.1\text{pF}$)	36.0	J ($\pm 5\%$)
2.7		39.0	
4.7		47.0	
5.1		51.0	
6.8		56.0	
8.2		68.0	
9.1		82.0	
10.0		100.0	
13.0		120.0	
15.0	130.0		
18.0	J ($\pm 5\%$)	240.0	J ($\pm 5\%$)
20.0		300.0	
24.0		390.0	
27.0		470.0	
30.0		680.0	

***25 each of 30 values

SOLUTIONS ACROSS THE BOARD

Capacitors

Advanced Power Film
Ceramic
Disc
Film
Glass
High Voltage
Leaded / Through Hole
Low ESR
Low Inductance
Military / Aerospace
MLCC Array
MOS / MIS
Niobium Oxide* (OxiCap®)
RF / Microwave
 (Power, Hi Q, Thin-Film)
Single Layer (SLC)
SMPS (Power Supply)
Stacked Ceramic
Supercapacitor (BestCap™)
Tantalum
Tantalum Polymer
Trimmer

Circuit Protection

Fuses (Thin-Film)
MLV (TransGuard™)
MLV Array (MultiGuard™)
NTC Thermistors
Transient Voltage Suppressors
Zinc Oxide Varistors

Filters

EMI (Bolt-In and SMD)
EMI / TVS Filter
Feedthrough
High Current Feedthrough
Low Pass (Thin-Film)
SAW

RF / Microwave

Capacitors
Couplers
Inductors
PMC Custom Filters
Modules
Timing Devices
Passive Micro Components (PMC)

Integrated Passives

IDC (Low Inductance Array)
Passive Thick Film Array
Passive Micro Components (PMC)

Module Devices

Antenna Switch
Bluetooth
LTCC
GPS
RX Module
WLAN Module

Piezo

Acoustic Devices
Actuators

Resistive Devices

Arrays
Low Resistance
Mini Axial
Thin-Film

Timing Devices

Ceramic Resonator
Clock Oscillator
Crystal Applied Product
MHz Crystal
SAW Resonator
TCXO

Connectors

2mm Hard Metric
Automotive – Custom
Battery
Board to Board
 1 piece Compression
 2 piece Microleaf
Card Edge
DIN41612
FFC / FPC
IDC
Memory Connectors
 PCMCIA Kits
 Compact Flash
 SO-DIMM
 SIMM / RUIIM
 SDIO / SD
Military
PCI Express
Varicon Rack and Panel

**For more information please visit
our website at
<http://www.avxrf.com>**

NOTICE: Specifications are subject to change without notice. Contact your nearest AVX Sales Office for the latest specifications. All statements, information and data given herein are believed to be accurate and reliable, but are presented without guarantee, warranty, or responsibility of any kind, expressed or implied. Statements or suggestions concerning possible use of our products are made without representation or warranty that any such use is free of patent infringement and are not recommendations to infringe any patent. The user should not assume that all safety measures are indicated or that other measures may not be required. Specifications are typical and may not apply to all applications.

© AVX Corporation

AMERICAS

AVX Myrtle Beach, SC
Tel: 843-448-9411

AVX Northwest, WA
Tel: 360-699-8746

AVX Midwest, IN
Tel: 317-861-9184

AVX Mid/Pacific, CA
Tel: 408-988-4900

AVX Northeast, MA
Tel: 617-479-0345

AVX Southwest, CA
Tel: 949-859-9509

AVX Canada
Tel: 905-238-3151

AVX South America
Tel: +55-11-4688-1960

EUROPE

AVX Limited, England
Tel: +44-1252-770000

AVX S.A.S., France
Tel: +33-1-69-18-46-00

AVX GmbH, Germany
Tel: +49-8131-9004-0

AVX SRL, Italy
Tel: +39-02-614-571

AVX Czech Republic
Tel: +420-57-57-57-521

AVX/ELCO UK
Tel: +44-1638-675000

ELCO Europe GmbH
Tel: +49-2741-299-0

AVX S.A., Spain
Tel: +34-91-63-97-197

AVX Benelux
Tel: +31-187-489-337

ASIA-PACIFIC

**AVX/Kyocera (S) Pte Ltd.,
Singapore**
Tel: +65-6286-7555

**AVX/Kyocera, Asia, Ltd.,
Hong Kong**
Tel: +852-2363-3303

**AVX/Kyocera Yuhan Hoesa,
South Korea**
Tel: +82-2785-6504

**AVX/Kyocera HK Ltd.,
Taiwan**
Tel: +886-2-2656-0258

**AVX/Kyocera (M) Sdn Bhd,
Malaysia**
Tel: +60-4228-1190

**AVX/Kyocera International
Trading Co. Ltd.,
Shanghai**
Tel: +86-21-3255 1933

**AVX/Kyocera Asia Ltd.,
Shenzen**
Tel: +86-755-3336-0615

**AVX/Kyocera International
Trading Co. Ltd.,
Beijing**
Tel: +86-10-6588-3528

**AVX/Kyocera India
Liaison Office**
Tel: +91-80-6450-0715

ASIA-KED

(KYOCERA Electronic Devices)

KED Hong Kong Ltd.
Tel: +852-2305-1080/1223

**KED Hong Kong Ltd.
Shenzen**
Tel: +86-755-3398-9600

**KED Company Ltd.
Shanghai**
Tel: +86-21-3255-1833

**KED Hong Kong Ltd.
Beijing**
Tel: +86-10-5869-4655

KED Taiwan Ltd.
Tel: +886-2-2950-0268

**KED Korea Yuhan Hoesa,
South Korea**
Tel: +82-2-783-3604/6126

**KED (S) Pte Ltd.
Singapore**
Tel: +65-6509-0328

**Kyocera Corporation
Japan**
Tel: +81-75-604-3449

Contact:

